

Fonctionnal if equipped

<input checked="" type="checkbox"/> Lock	<input checked="" type="checkbox"/> Tach	<input checked="" type="checkbox"/> Radio Off	<input checked="" type="checkbox"/> Heat Seats
<input checked="" type="checkbox"/> Unlock	<input checked="" type="checkbox"/> Start Enable	<input checked="" type="checkbox"/> Transponder Bypass	<input type="checkbox"/> Gas Door
<input checked="" type="checkbox"/> Arm	<input checked="" type="checkbox"/> Door Trigger	<input checked="" type="checkbox"/> PK3, Passlock	<input type="checkbox"/> Window Roll Down
<input checked="" type="checkbox"/> Disarm	<input checked="" type="checkbox"/> Trunk Trigger	<input type="checkbox"/> Sliding Door	<input checked="" type="checkbox"/> Hatch
<input checked="" type="checkbox"/> Trunk	<input checked="" type="checkbox"/> Hood Trigger	<input type="checkbox"/> Defrost	<input type="checkbox"/> Brake Signal

Remote-Starter Connection for Transponder bypass

WARNING: All Ignition and accessory wires of the remote starter must be connected at the ignition connector.

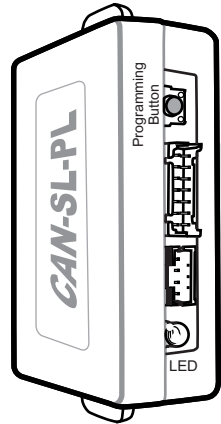

Front of the module

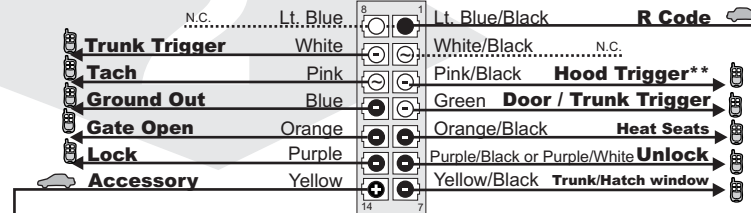
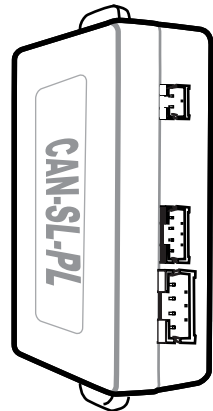

** Only if the vehicle is equipped with a hood pin.

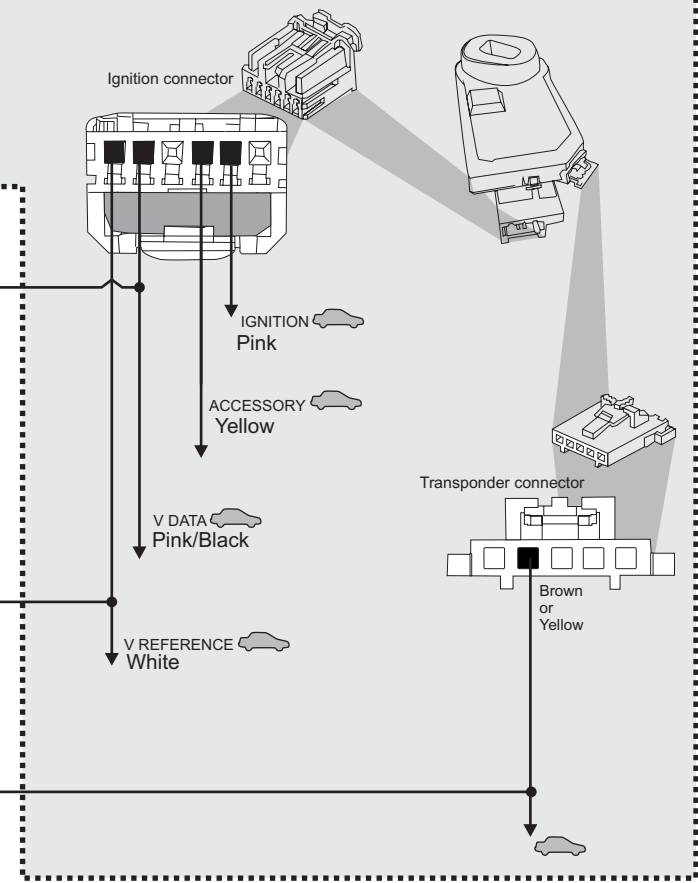
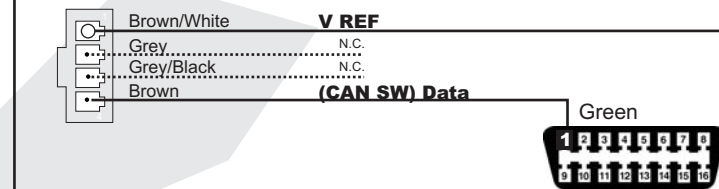

Connect wire to Remote-Starter/Alarm Connect wire to vehicle

○ OUTPUT ● INPUT

Connect: Branchez:

Lt. Blue	<input checked="" type="checkbox"/>	Lt. Blue/Black	<input checked="" type="checkbox"/>
White	<input checked="" type="checkbox"/>	White/Black	<input checked="" type="checkbox"/>
Pink	<input checked="" type="checkbox"/>	Pink/Black	<input checked="" type="checkbox"/>
Blue	<input checked="" type="checkbox"/>	Green	<input checked="" type="checkbox"/>
Orange	<input checked="" type="checkbox"/>	Orange/Black	<input checked="" type="checkbox"/>
Purple	<input checked="" type="checkbox"/>	Purple/Black	<input checked="" type="checkbox"/>
Yellow	<input checked="" type="checkbox"/>	Yellow/Black	<input checked="" type="checkbox"/>

Data-Link (1 way)



Brown/White	<input checked="" type="checkbox"/>
Grey	<input checked="" type="checkbox"/>
Grey/Black	<input checked="" type="checkbox"/>
Brown	<input checked="" type="checkbox"/>

Connect: Branchez:

Lt. Blue	<input checked="" type="checkbox"/>	Lt. Blue/Black	<input checked="" type="checkbox"/>
White	<input checked="" type="checkbox"/>	White/Black	<input checked="" type="checkbox"/>
Pink	<input checked="" type="checkbox"/>	Pink/Black	<input checked="" type="checkbox"/>
Blue	<input checked="" type="checkbox"/>	Green	<input checked="" type="checkbox"/>
Orange	<input checked="" type="checkbox"/>	Orange/Black	<input checked="" type="checkbox"/>
Purple	<input checked="" type="checkbox"/>	Purple/Black	<input checked="" type="checkbox"/>
Yellow	<input checked="" type="checkbox"/>	Yellow/Black	<input checked="" type="checkbox"/>

Data-Link (2 way)



Brown/White	<input checked="" type="checkbox"/>
Grey	<input checked="" type="checkbox"/>
Grey/Black	<input checked="" type="checkbox"/>
Brown	<input checked="" type="checkbox"/>

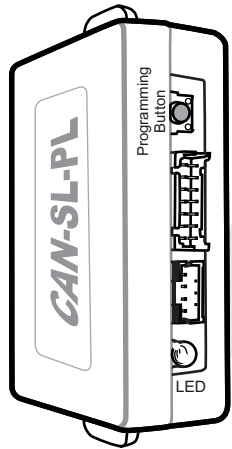

Front of the module

Connector 1 (Black - 4 pins):
Determine the type of installation:

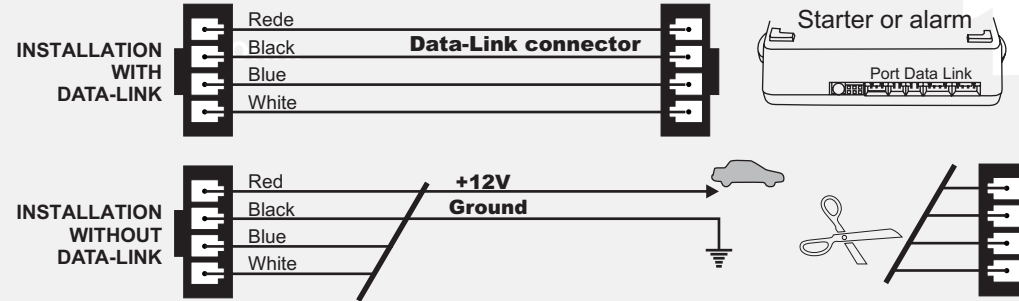

Cut off one plug of the Data-Link connector, connect the red wire to +12V and the black wire to ground.

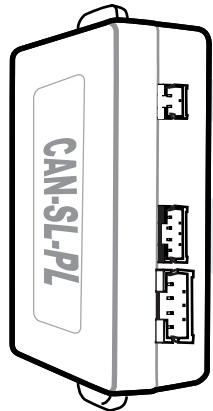

PATS-LINK

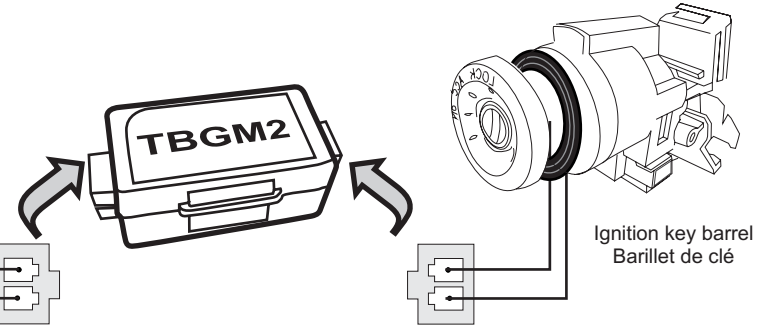

Ignition key barrel
Barillet de clé

ANTENNA-RING
ANTENNE-ANNEAU





Connector 4 (White - 4 pins):
Connect with the FLASH LINK UPDATER for web update.

Connect wire to Remote-Starter/Alarm Connect wire to vehicle

○ OUTPUT ● INPUT

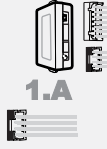
CAN-SL-PL PROGRAMMING

1 **1.A**  **Make the connections of the CAN-SL-PL to the vehicle:**
Connector 1 (Black):
Determine the type of installation:
INSTALLATION WITH DATA-LINK
INSTALLATION WITHOUT DATA-LINK

1.B  **Connector 2 (White):**
Make the connections

1.C  **Connector 3 (White, located at the back of the module):**
Make the connections

2  **Press** the programming switch while inserting the main wires harness (**CONN 1**) into the CAN-SL-PL module. The LED will illuminate to indicate you are in programming mode, release the programming button.

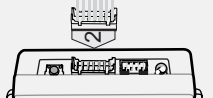
3  **Connect** the other connectors (**CONN. 2**)
WARNING: Connector 2 can be easily plugged in backwards.

4  **Connect** the other connectors (**CONN. 3**)

5  Turn the key to the **"ON" position**.

6  Once the LED starts to flash rapidly turn the key to the **OFF position**.
The LED will turn off to indicate the module has been programmed.

 **The module is now ready for use.**

TBGM2 PROGRAMMING

7  Insert the key and turn the cylinder to the **ON/RUN** position for **1 second**.

8  Remove the key.

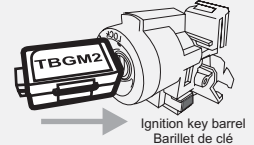
9  Place the TBGM2 module close to the front of the ignition barrel.
Ignition key barrel
Barillet de clé

YOU HAVE 5 SECONDS TO COMPLETE THE FOLLOWING STEP

10  Remote-Start the vehicle.
THE TBGM2 IS NOW PROGRAMMED.

IMPORTANT:
Once the **TBGM2** is programmed, it can not be programmed on another vehicle.

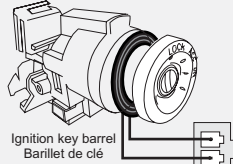
11  **Remove** the trim cap from the ignition barrel.
Stick the antenna to the ignition barrel.
Replace the trim cap on the ignition barrel.

12  Connect the TBGM2 module to the CAN-SL-PL using the PATS-LINK cable.

Fonctionnel if equipped

- | | | | |
|--|--|--|---|
| <input checked="" type="checkbox"/> Verrouillage | <input checked="" type="checkbox"/> Tach | <input checked="" type="checkbox"/> Radio Off | <input checked="" type="checkbox"/> Sièges chauffants |
| <input checked="" type="checkbox"/> Déverrouillage | <input checked="" type="checkbox"/> Active Démarreur | <input checked="" type="checkbox"/> Transponder Bypass | <input type="checkbox"/> Porte essence |
| <input checked="" type="checkbox"/> Armement | <input checked="" type="checkbox"/> Status de Porte | <input checked="" type="checkbox"/> PK3, Passlock | <input type="checkbox"/> Contrôle portes |
| <input checked="" type="checkbox"/> Désarmement | <input checked="" type="checkbox"/> Status de Valise | <input type="checkbox"/> Portes Couissantes | <input checked="" type="checkbox"/> Hayon arrière |
| <input checked="" type="checkbox"/> Valise | <input checked="" type="checkbox"/> Status de Capot | <input type="checkbox"/> Dégivrage | <input type="checkbox"/> Signal de Frein |

Démarreur à distance Connexion pour le contournement transpondeur.

ATTENTION: Les fils d'ignition et d'accessoire du démarreur à distance doivent être connectés au connecteur d'ignition.

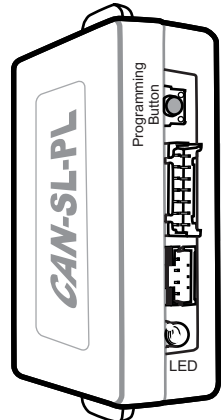

Module vue de face

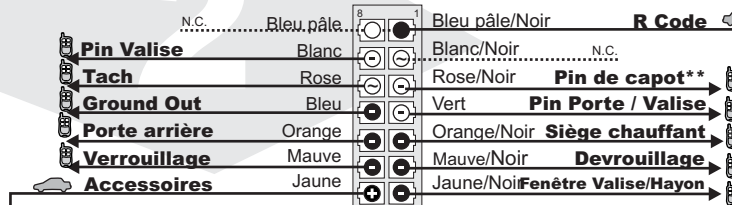
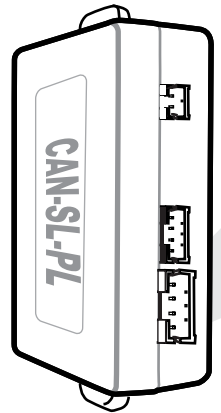

** Seulement si le véhicule est équipé de la pin de capot.

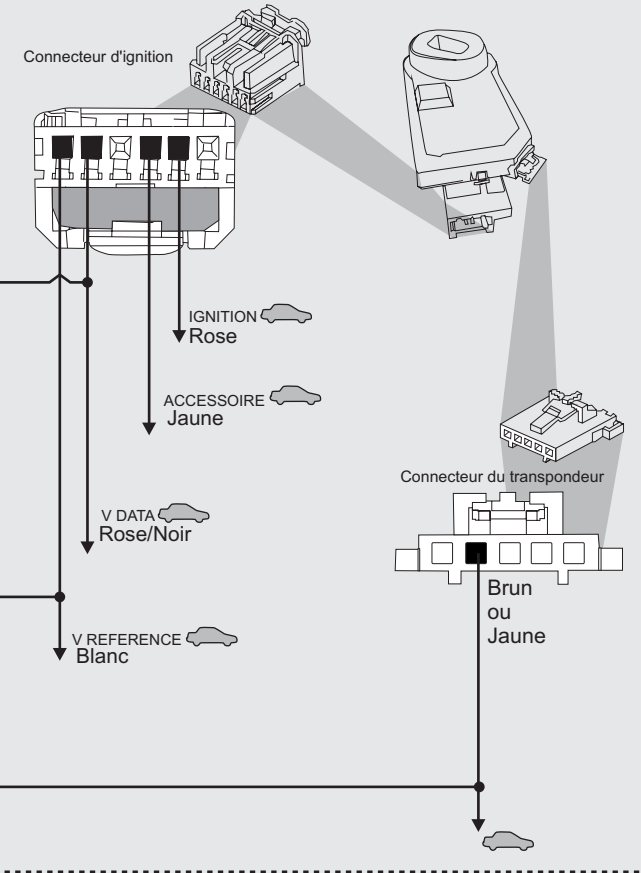
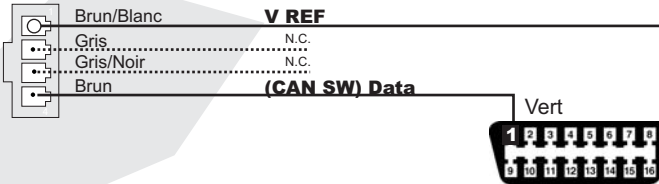

Branchement du filage au démarreur à distance/Alarme Branchement du filage au véhicule ○ SORTIE ● ENTRÉE

<p>Branchez: ✓</p> <table border="0"> <tr><td>Bleu pâle</td><td><input checked="" type="checkbox"/></td><td>1</td><td>Bleu pâle/Noir</td><td><input checked="" type="checkbox"/></td></tr> <tr><td>Blanc</td><td><input checked="" type="checkbox"/></td><td>2</td><td>Blanc/Noir</td><td><input checked="" type="checkbox"/></td></tr> <tr><td>Rose</td><td><input checked="" type="checkbox"/></td><td>3</td><td>Rose/Noir</td><td><input checked="" type="checkbox"/></td></tr> <tr><td>Bleu</td><td><input checked="" type="checkbox"/></td><td>4</td><td>Vert</td><td><input checked="" type="checkbox"/></td></tr> <tr><td>Orange</td><td><input type="checkbox"/></td><td>5</td><td>Orange/Noir</td><td><input type="checkbox"/></td></tr> <tr><td>Mauve</td><td><input type="checkbox"/></td><td>6</td><td>Mauve/Noir</td><td><input type="checkbox"/></td></tr> <tr><td>Jaune</td><td><input type="checkbox"/></td><td>7</td><td>Jaune/Noir</td><td><input type="checkbox"/></td></tr> </table>	Bleu pâle	<input checked="" type="checkbox"/>	1	Bleu pâle/Noir	<input checked="" type="checkbox"/>	Blanc	<input checked="" type="checkbox"/>	2	Blanc/Noir	<input checked="" type="checkbox"/>	Rose	<input checked="" type="checkbox"/>	3	Rose/Noir	<input checked="" type="checkbox"/>	Bleu	<input checked="" type="checkbox"/>	4	Vert	<input checked="" type="checkbox"/>	Orange	<input type="checkbox"/>	5	Orange/Noir	<input type="checkbox"/>	Mauve	<input type="checkbox"/>	6	Mauve/Noir	<input type="checkbox"/>	Jaune	<input type="checkbox"/>	7	Jaune/Noir	<input type="checkbox"/>	<p>Data-Link (1 way)</p> <p>DL →</p> <table border="0"> <tr><td><input checked="" type="checkbox"/></td><td>Brun/Blanc</td></tr> <tr><td><input checked="" type="checkbox"/></td><td>Gris</td></tr> <tr><td><input checked="" type="checkbox"/></td><td>Gris/Noir</td></tr> <tr><td><input checked="" type="checkbox"/></td><td>Brun</td></tr> </table>	<input checked="" type="checkbox"/>	Brun/Blanc	<input checked="" type="checkbox"/>	Gris	<input checked="" type="checkbox"/>	Gris/Noir	<input checked="" type="checkbox"/>	Brun	<p>Branchez: ✓</p> <table border="0"> <tr><td>Bleu pâle</td><td><input checked="" type="checkbox"/></td><td>1</td><td>Bleu pâle/Noir</td><td><input checked="" type="checkbox"/></td></tr> <tr><td>Blanc</td><td><input checked="" type="checkbox"/></td><td>2</td><td>Blanc/Noir</td><td><input checked="" type="checkbox"/></td></tr> <tr><td>Rose</td><td><input checked="" type="checkbox"/></td><td>3</td><td>Rose/Noir</td><td><input checked="" type="checkbox"/></td></tr> <tr><td>Bleu</td><td><input checked="" type="checkbox"/></td><td>4</td><td>Vert</td><td><input checked="" type="checkbox"/></td></tr> <tr><td>Orange</td><td><input type="checkbox"/></td><td>5</td><td>Orange/Noir</td><td><input type="checkbox"/></td></tr> <tr><td>Mauve</td><td><input type="checkbox"/></td><td>6</td><td>Mauve/Noir</td><td><input type="checkbox"/></td></tr> <tr><td>Jaune</td><td><input type="checkbox"/></td><td>7</td><td>Jaune/Noir</td><td><input type="checkbox"/></td></tr> </table>	Bleu pâle	<input checked="" type="checkbox"/>	1	Bleu pâle/Noir	<input checked="" type="checkbox"/>	Blanc	<input checked="" type="checkbox"/>	2	Blanc/Noir	<input checked="" type="checkbox"/>	Rose	<input checked="" type="checkbox"/>	3	Rose/Noir	<input checked="" type="checkbox"/>	Bleu	<input checked="" type="checkbox"/>	4	Vert	<input checked="" type="checkbox"/>	Orange	<input type="checkbox"/>	5	Orange/Noir	<input type="checkbox"/>	Mauve	<input type="checkbox"/>	6	Mauve/Noir	<input type="checkbox"/>	Jaune	<input type="checkbox"/>	7	Jaune/Noir	<input type="checkbox"/>	<p>Data-Link (2 way)</p> <p>← DL →</p> <table border="0"> <tr><td><input checked="" type="checkbox"/></td><td>Brun/Blanc</td></tr> <tr><td><input checked="" type="checkbox"/></td><td>Gris</td></tr> <tr><td><input checked="" type="checkbox"/></td><td>Gris/Noir</td></tr> <tr><td><input checked="" type="checkbox"/></td><td>Brun</td></tr> </table>	<input checked="" type="checkbox"/>	Brun/Blanc	<input checked="" type="checkbox"/>	Gris	<input checked="" type="checkbox"/>	Gris/Noir	<input checked="" type="checkbox"/>	Brun
Bleu pâle	<input checked="" type="checkbox"/>	1	Bleu pâle/Noir	<input checked="" type="checkbox"/>																																																																																					
Blanc	<input checked="" type="checkbox"/>	2	Blanc/Noir	<input checked="" type="checkbox"/>																																																																																					
Rose	<input checked="" type="checkbox"/>	3	Rose/Noir	<input checked="" type="checkbox"/>																																																																																					
Bleu	<input checked="" type="checkbox"/>	4	Vert	<input checked="" type="checkbox"/>																																																																																					
Orange	<input type="checkbox"/>	5	Orange/Noir	<input type="checkbox"/>																																																																																					
Mauve	<input type="checkbox"/>	6	Mauve/Noir	<input type="checkbox"/>																																																																																					
Jaune	<input type="checkbox"/>	7	Jaune/Noir	<input type="checkbox"/>																																																																																					
<input checked="" type="checkbox"/>	Brun/Blanc																																																																																								
<input checked="" type="checkbox"/>	Gris																																																																																								
<input checked="" type="checkbox"/>	Gris/Noir																																																																																								
<input checked="" type="checkbox"/>	Brun																																																																																								
Bleu pâle	<input checked="" type="checkbox"/>	1	Bleu pâle/Noir	<input checked="" type="checkbox"/>																																																																																					
Blanc	<input checked="" type="checkbox"/>	2	Blanc/Noir	<input checked="" type="checkbox"/>																																																																																					
Rose	<input checked="" type="checkbox"/>	3	Rose/Noir	<input checked="" type="checkbox"/>																																																																																					
Bleu	<input checked="" type="checkbox"/>	4	Vert	<input checked="" type="checkbox"/>																																																																																					
Orange	<input type="checkbox"/>	5	Orange/Noir	<input type="checkbox"/>																																																																																					
Mauve	<input type="checkbox"/>	6	Mauve/Noir	<input type="checkbox"/>																																																																																					
Jaune	<input type="checkbox"/>	7	Jaune/Noir	<input type="checkbox"/>																																																																																					
<input checked="" type="checkbox"/>	Brun/Blanc																																																																																								
<input checked="" type="checkbox"/>	Gris																																																																																								
<input checked="" type="checkbox"/>	Gris/Noir																																																																																								
<input checked="" type="checkbox"/>	Brun																																																																																								

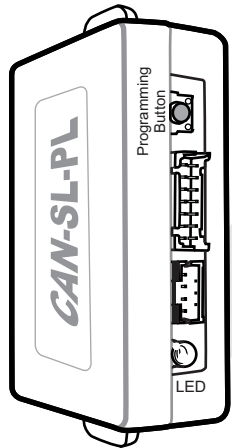

Front of the module

1

Connecteur 1 (Noir - 4 pins):
Déterminez le type d'installation:

INSTALLATION AVEC DATA-LINK

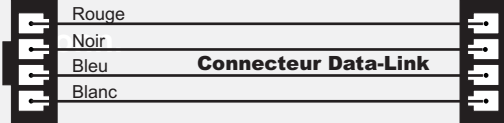

Démarrreur à distance et Alarme



INSTALLATION SANS DATA-LINK

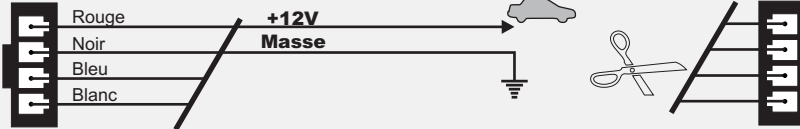

Coupez les 4 fils à l'extrémité de l'un des deux connecteurs Data-Link. Connectez le fil rouge au 12V et le fil noir à la masse du véhicule.

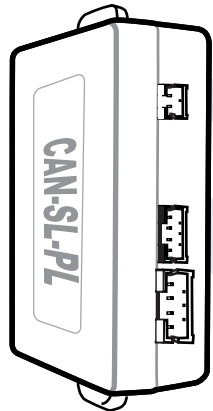

5

Connecteur pour mise à jour par internet*
*Connecteur non fournis

Connecteur 4 (Blanc - 4 pins):
Connectez avec le *FLASH LINK UPDATER* pour les mises à jour par internet.

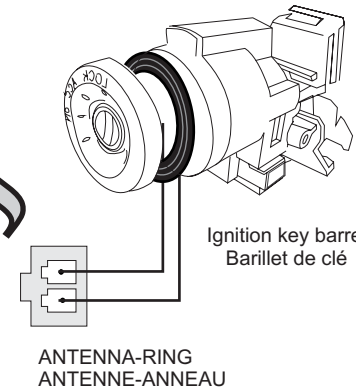

Branchement du filage au démarreur à distance/Alarme Branchement du filage au véhicule ○ SORTIE ● ENTRÉE

CAN-SL-PL PROGRAMMING

1 **1.A** **Connecteur 1 (Noir):**
Déterminez le type d'installation (**Data-Link** ou **non Data-Link**)
Pour l'installation DATA-LINK assurez vous de la présence du connecteur DATA-LINK sur le démarreur.
Pour installation non Data-Link voir INSTALLATION SANS DATA-LINK.

1.B **Connecteur 2 (Blanc):**
Éffectuez les branchements

1.C **Connecteur 3 (Blanc, situé au dos du module):**
Éffectuez les branchements

2 **Maintenez le bouton de programmation enfoncé** en insérant le **connecteur 1** dans le CAN-SL-PL
Le DEL s'allume pour indiquer le début de la programmation, **relâchez le bouton de programmation.**

3 Branchez le connecteur 2 (**CONN. 2**)
ATTENTION: Ne pas brancher le connecteur à l'envers.

4 Branchez le connecteur 3 (**CONN. 3**)

5 Tournez la clef en position **ignition.**

6 Lorsque le DEL clignote rapidement, **tournez la clef en position OFF.**
Le DEL s'éteint pour indiquer que le module est programmé.

TBGM2 PROGRAMMING

7 Introduisez la première clé dans le contact et tournez-la à la position **ON** pendant **1 secondes.**

8 Retirez la clé.

9 Placez le module TBGM2 prêt du devant du barillet d'ignition.

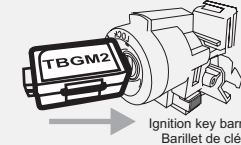

VOUS AVEZ 5 SECONDES POUR EFFECTUEZ L'ÉTAPE SUIVANTE:

10 Démarrez le véhicule avec le démarreur à distance.
Le TBGM2 EST PROGRAMMÉ.



IMPORTANT : Une fois le TBGM2 programmé, il ne peut être reprogrammé sur un autre véhicule.

11

- ▶ Retirez le capuchon du plastique du barillet d'ignition.
- ▶ Collez l'antenne (ring) autour du barillet d'ignition.
- ▶ Réinstallez le capuchon du barillet d'ignition.

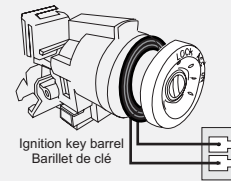

12 Branchez le module TBGM2 dans le module CAN-SL-PL en utilisant le PATS-LINK.

