



THAR-CHR5

FOR EVO-ALL | POUR EVO-ALL

INSTALLATION GUIDE FOR T-HARNESS FOR CHRYLSER, DODGE & JEEP VEHICLE
GUIDE INSTALLATION POUR HARNAIS EN T POUR VÉHICULES CHRYLSER, DODGE & JEEP

EVO-ALL REQUIRED

NOT INCLUDED. FIRMWARE VERSION 4.09+ REQUIRED

EVO-ALL REQUIS

NON INCLUS. VERSION LOGICIEL 4.09+ REQUISE.

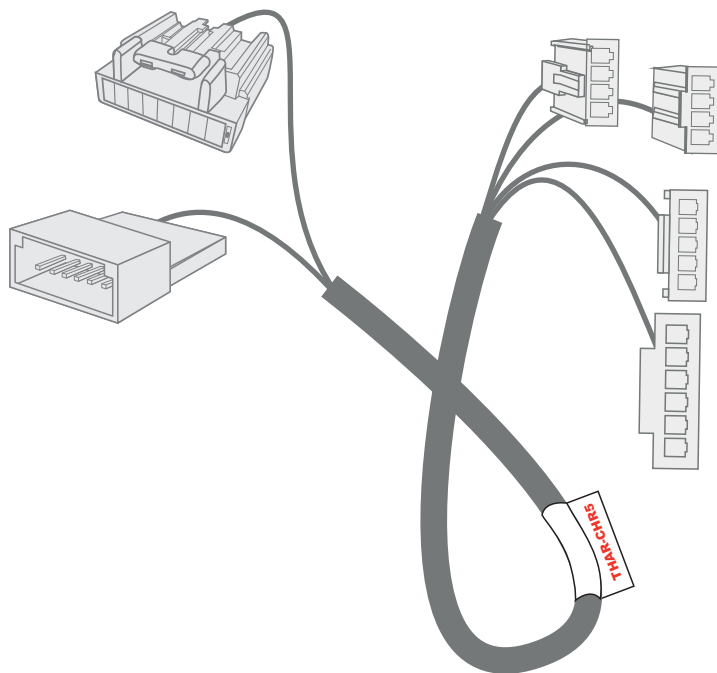

TECH SUPPORT

Tél: 514-255-HELP (4357)

1-877-336-7797

Fax: 514-255-1367



INSTALLATION GUIDE

Rev. 20130219

www.fortinbypass.com

PARTS REQUIRED

PIÈCES REQUISES

	HARDWARE VERSION VERSION DU MATÉRIEL	FIRMWARE VERSION VERSION DU LOGICIEL
	Minimum 4	Minimum 4.09

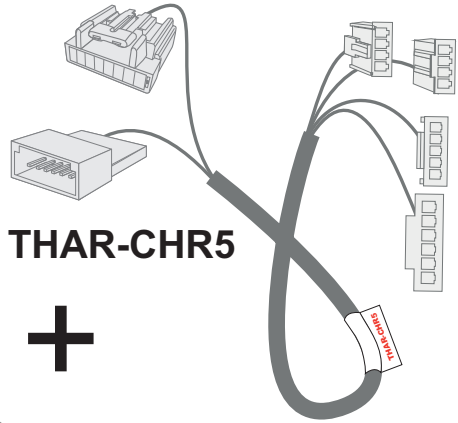

THAR-CHR5



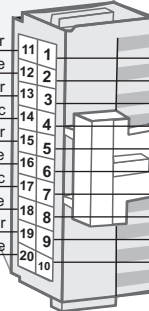

A 20 PIN CONNECTOR:
MAIN HARNESS | HARNAIS PRINCIPAL
(WHITE|BLANC)

Foot Brake Frein (pied) Signal	Black Noir	11	1	Yellow Jaune	Ignition
Tachometer	Pink Rose	12	2	Purple Mauve	Lock Verrouille
Trunk Release Valise	Yellow/Black Jaune/Noir	13	3	Purple/White Mauve/Blanc	Unlock Déverrouille
Hand Brake Frein à Main Signal	Brown/White Brun/Blanc	14	4	Green Vert	Door Status Statuts Portes
Hood Status Capot Statuts	Pink/Black Rose/Noir	15	5	White Blanc	Trunk Status Statuts Valise
See configuration	Purple/Yellow Mauve/Jaune	16	6	Orange	(-) Sliding Door Left
See configuration	Green/White Vert/Blanc	17	7	Orange/Black Orange/Noir	(-) Sliding Door Right
See configuration	Green/Red Vert/Rouge	18	8	Dk. Blue Bleu foncé	GWR (Ground While Running)
See configuration	White/Black Blanc/Noir	19	9	Red/Blue Rouge/Bleu	See configuration
See configuration	Lt. Blue Bleu Pâle	20	10	Lt. Blue/Black Bleu Pâle/Noir	See configuration



LED | DEL

Blue Bleu	
Yellow Jaune	
Red Rouge	

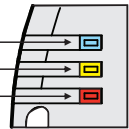

Notice: Updated Firmware and Installation Guides

Updated firmware and installation guides are posted on our web site on a regular basis. We recommend that you update this module to the latest firmware and download the latest installation guide(s) prior to the installation of this product.

Des mises à jour du Firmware (microprogramme) et des guides d'installation sont mis en ligne régulièrement. Vérifiez que vous avez bien la dernière version logiciel et le dernier guide d'installation avant l'installation de ce produit.



HARDWARE VERSION
Date: xx-xx

EVO-ALL
INTERFACE MODULE
PATENTS PENDING US: 2007-228827-A1
Made in Canada www.fortinbypass.com



Service No. : 000 102 04 2536

Module label | Étiquette sur le module

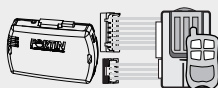
VEHICLE FIT GUIDE
GUIDE DES VÉHICULES

Determine if the remote-starter or alarm system supports 2-way Data-Link.

Déterminez si le démarreur à distance ou système d'alarme est compatible en Data-Link 2-voies.

VEHICLE VÉHICULES	YEARS ANNÉES	CONNECTION			VEHICLE FUNCTIONALITY (IF EQUIPPED) FONCTIONS S'APPLIQUENT SI LE VÉHICULE EN EST ÉQUIPÉ																						
		With Data-Link Avec Data-Link	Without Data-Link Sans Data-Link	Stand alone démarreur autonome	Lock	Unlock	Arm	Disarm	Hatch (open)	Trunk (open)	Sliding Door	Window Roll Down	Gas Door	RAP Disable	Parking Light	Memory Driver	Tachometer	Heated Seats	Heated Mirrors	Rear Defrost	Door Status	Trunk Status	Hood Status	Hand-Brake Status	Foot-Brake Status	Transponder Bypass	PK3, Passlock
CHRYSLER																											
200	2011-2013	A	B	C	*	*	*	*	*	*	*	*	*	*	*	*	*	*	*	*	*	*	*	*	*	*	*
300-300C	2005-2007	D	E	F	*	*	*	*	*	*	*	*	*	*	*	*	*	*	*	*	*	*	*	*	*	*	*
Aspen	2007-2009	A	B	C	*	*	*	*	*	*	*	*	*	*	*	*	*	*	*	*	*	*	*	*	*	*	*
Crossfire	2008	A	B	C	*	*	*	*	*	*	*	*	*	*	*	*	*	*	*	*	*	*	*	*	*	*	*
PT Cruiser	2006-2010	D	E	F	*	*	*	*	*	*	*	*	*	*	*	*	*	*	*	*	*	*	*	*	*	*	*
Sebring	2007	D	E	F	*	*	*	*	*	*	*	*	*	*	*	*	*	*	*	*	*	*	*	*	*	*	*
	2008-2010	A	B	C	*	*	*	*	*	*	*	*	*	*	*	*	*	*	*	*	*	*	*	*	*	*	*
DODGE																											
Avenger	2008-2013	A	B	C	*	*	*	*	*	*	*	*	*	*	*	*	*	*	*	*	*	*	*	*	*	*	*
Caliber	2007	D	E	F	*	*	*	*	*	*	*	*	*	*	*	*	*	*	*	*	*	*	*	*	*	*	*
	2008-2012	A	B	C	*	*	*	*	*	*	*	*	*	*	*	*	*	*	*	*	*	*	*	*	*	*	*
Charger	2006-2007	D	E	F	*	*	*	*	*	*	*	*	*	*	*	*	*	*	*	*	*	*	*	*	*	*	*
Dakota	2005-2006	G	H	N.A.	*	*	*	*	*	*	*	*	*	*	*	*	*	*	*	*	*	*	*	*	*	*	*
	2007-2012	A	B	C	*	*	*	*	*	*	*	*	*	*	*	*	*	*	*	*	*	*	*	*	*	*	*
Durango	2004-2006	G	H	N.A.	*	*	*	*	*	*	*	*	*	*	*	*	*	*	*	*	*	*	*	*	*	*	*
	2007-2009	A	B	C	*	*	*	*	*	*	*	*	*	*	*	*	*	*	*	*	*	*	*	*	*	*	*
Magnum	2005-2008	D	E	F	*	*	*	*	*	*	*	*	*	*	*	*	*	*	*	*	*	*	*	*	*	*	*
Nitro	2007-2011	A	B	C	*	*	*	*	*	*	*	*	*	*	*	*	*	*	*	*	*	*	*	*	*	*	*
RAM	2006-2007	D	E	F	*	*	*	*	*	*	*	*	*	*	*	*	*	*	*	*	*	*	*	*	*	*	*
	2008	A	B	C	*	*	*	*	*	*	*	*	*	*	*	*	*	*	*	*	*	*	*	*	*	*	*
JEEP																											
Commander	2006-2007	D	E	F	*	*	*	*	*	*	*	*	*	*	*	*	*	*	*	*	*	*	*	*	*	*	*
Compass	2007	D	E	F	*	*	*	*	*	*	*	*	*	*	*	*	*	*	*	*	*	*	*	*	*	*	*
	2008-2013	A	B	C	*	*	*	*	*	*	*	*	*	*	*	*	*	*	*	*	*	*	*	*	*	*	*
Grand Cherokee	2005-2007	D	E	F	*	*	*	*	*	*	*	*	*	*	*	*	*	*	*	*	*	*	*	*	*	*	*
Liberty	2008-2013	A	B	C	*	*	*	*	*	*	*	*	*	*	*	*	*	*	*	*	*	*	*	*	*	*	*
Patriot	2007-2013	A	B	C	*	*	*	*	*	*	*	*	*	*	*	*	*	*	*	*	*	*	*	*	*	*	*
Wrangler	2007-2012	A	B	C	*	*	*	*	*	*	*	*	*	*	*	*	*	*	*	*	*	*	*	*	*	*	*

**EVO-ALL PROGRAMMING
PROCEDURE**
**PROCÉDURE DE PROGRAMMATION
DU EVO-ALL**

See Page 14

**WITH DATA-LINK
AVEC DATA-LINK**

In order to utilize this type of connection the remote-starter or alarm-system must be compatible with the **Fortin Data-link protocol**. Consult the installation guide or visit www.fortinbypass.com/datalink/ for more information.

Le démarreur à distance ou le système d'alarme doit être compatible avec le **protocole Data-link Fortin** pour ces branchements. Consultez le guide d'installation du démarreur à distance ou du système d'alarme ou visitez le www.fortinbypass.com/datalink/ pour plus d'informations.

**WITH OUT DATA-LINK
SANS DATA-LINK**

For all other remote-starters or alarm-systems perform the following connections.

Pour tout autres types de démarreurs à distance ou d'alarme, effectuez les branchements suivants.

**STAND ALONE
DÉMARREUR AUTONOME**

A remote car starter installation can be completed using only the interface module. An after-market remote car starter not required.

Un installation de démarreur à distance peut être complété avec seulement ce module. Pas de démarreur à distance nécessaire.

NOTE**12V BATTERY****12V BATTERIE****ATTENTION
THE T-HARNESS CURRENT
IS LIMITED AT 10 AMP MAXIMUM.**

If the parking lights (+) require more than 10Amp. connect the remote-starter's power directly to the vehicles battery with the appropriate fuse.

Some remote starters can not be powered through Data-Link. In these cases connect the remote starter's fused 12V power wire directly to the T-Harness.

**ATTENTION LE COURANT DU 12V PROVENANT
DU HARNAIS-EN-T EST LIMITÉ À 10 AMPÈRES
MAXIMUM.**

Si les lumières de stationnement (+) requièrent plus de 10 Ampères, branchez le 12V du démarreur à distance directement à la batterie du véhicule avec le fusible approprié.

Certains démarreurs à distance NE peuvent PAS être alimentés par le Data-Link. Dans ce cas, branchez le 12V (avec fusible) du démarreur à distance directement au harnais-en-T.

WIRECOLOR
COULEURS DE FIL

		YEARS	
VEHICLE VEHICULES		ANNÉES	
CHRYSLER			
200	2011-2013	(+) PARKING LIGHT WHITE/PURPLE DRIVER RUNNING BOARD HARNESS	
300-300C	2005-2007	(-) PARKING LIGHT WHITE/BROWN LIGHT SWITCH HARNESS 2.4K OHM RESISTOR MUX: ~ VIOLET/BROWN START ~ : PINK/DKGREEN	
Aspen	2007-2009	(-) PARKING LIGHT PINK/RED PARKING LIGHT HARNESS 1K OHM RESISTOR	
Crossfire	2008	(+) PARKING LIGHT LEFT - GRAY/BLACK PARKING LIGHT HARNESS (+) PARKING LIGHT RIGHT - GRAY/RED PARKING LIGHT HARNESS	
PT Cruiser	2008-2010	(+) PARKING LIGHT WHITE/PURPLEBLACK CONNECTOR ABOVE OBD-II MUX ~: VIOLET/BROWN (DATA) START: PINK/LTBLUE	
Sebring	2007	(+) PARKING LIGHT WHITE/PURPLE DRIVER RUNNING BOARD HARNESS MUX ~: VIOLET/BROWN (DATA) START : PINK/LTBLUE	
	2008-2010	(+) PARKING LIGHT WHITE/PURPLE DRIVER RUNNING BOARD HARNESS	
DODGE			
Avenger	2008-2013	(+) PARKING LIGHT WHITE/PURPLE DRIVER RUNNING BOARD HARNESS	
Caliber	2007	(+) PARKING LIGHT WHITE/PURPLE DRIVER RUNNING BOARD HARNESS MUX ~: VIOLET/BROWN (DATA) START: PINK/BLUE	
	2008-2012	(+) PARKING LIGHT WHITE/PURPLE RUNNING BOARD HARNESS	
Charger	2006-2007	(-) PARKING LIGHT WHITE/BROWN PARKING LIGHT HARNESS 1K OHM RESISTOR MUX ~: VIOLET/BROWN (DATA) START: PINK/GREEN	
Dakota	2005-2006	(-) PARKING LIGHT PINK/RED PARKING LIGHT HARNESS 1.5K OHM RESISTOR (+) ACCESSORY1 PINK/WHITE (+) IGNITION1 PINK/GREY (+) START PINK/LT.BLUE (+) IGNITION2 PINK (+) ACCESSORY2 PURPLE (+)12V RED/BLUE (-) KEY SENSE PURPLE/TAN	
	2007-2012	(-) PARKING LIGHT PINK/RED PARKING LIGHT HARNESS 1.5K OHM RESISTOR	
Durango	2004	(-) PARKING LIGHT PINK/RED PARKING LIGHT HARNESS 1.5K OHM RESISTOR (+) ACCESSORY1 PINK/YELLOW (+) IGNITION1 PINK/GREEN (+) START PINK/LT.BLUE (+) IGNITION2 PINK (+) ACCESSORY2 PINK/TAN (+)12V RED/BLUE (-) KEY SENSE PURPLE/TAN	
	2005	(-) PARKING LIGHT PINK/RED PARKING LIGHT HARNESS 1.5K OHM RESISTOR (+) ACCESSORY1 PINK/GREEN (+) ACCESSORY2 PINK/TAN (+) IGNITION1 PINK/GREEN (+)12V RED/BLUE (+) START PINK/LT.BLUE (-) KEY SENSE PURPLE/TAN (+) IGNITION2 PINK	
	2006	(-) PARKING LIGHT PINK/RED PARKING LIGHT HARNESS 1.5K OHM RESISTOR (+) ACCESSORY1 PINK/YELLOW (+) IGNITION1 PINK/GREEN (+) START PINK/LT.BLUE (+) IGNITION2 PINK (+) ACCESSORY2 PINK/TAN (+)12V RED/BLUE (-) KEY SENSE PURPLE/TAN	
	2007-2009	(-) PARKING LIGHT PINK/RED PARKING LIGHT HARNESS 1.5K OHM RESISTOR	
Magnum	2005-2008	(-) PARKING LIGHT WHITE/BROWN LIGHT SWITCH HARNESS 2.5K OHM RESISTOR MUX ~: VIOLET/BROWN (DATA) START: PINK/GREEN	
Nitro	2007-2011	(+) PARKING LIGHT WHITE/PURPLE DRIVER RUNNING BOARD HARNESS	
RAM	2006-2007	(-) PARKING LIGHT WHITE/GREEN PARKING LIGHT HARNESS MULTIPLEX. 1.1K OHM RESISTOR MUX ~: VIOLET/BROWN (DATA) START: GREEN/YELLOW	
	2008	(-) PARKING LIGHT WHITE/GREEN PARKING LIGHT HARNESS MULTIPLEX. 1.1K OHM RESISTOR	
JEEP			
Commander	2006-2007	(-) PARKING LIGHT RELAY CENTER UNDER HOOD MUX ~: VIOLET/BROWN (DATA) START: PINK/ORANGE	
Compass	2007	(+) PARKING LIGHT WHITE/PURPLE RUNNING BOARD HARNESS MUX ~: VIOLET/BROWN (DATA) START: PINK/BLUE	
	2008-2013	(+) PARKING LIGHT WHITE/PURPLE RUNNING BOARD HARNESS	
Grand Cherokee	2005-2007	(-) PARKING LIGHT RELAY CENTER UNDER HOOD MUX ~: VIOLET/BROWN (DATA) START: PINK/ORANGE	
Liberty	2008-2013	(+) PARKING LIGHT WHITE/PURPLE DRIVER KICK PANEL	
Patriot	2007-2013	(+) PARKING LIGHT WHITE/PURPLE DRIVER KICK PANEL	
Wrangler	2007-2012	(+) PARKING LIGHT WHITE/PURPLE PASSENGER KICK PANEL	

A

INSTALLATION WITH DATA-LINK | INSTALLATION AVEC DATA-LINK

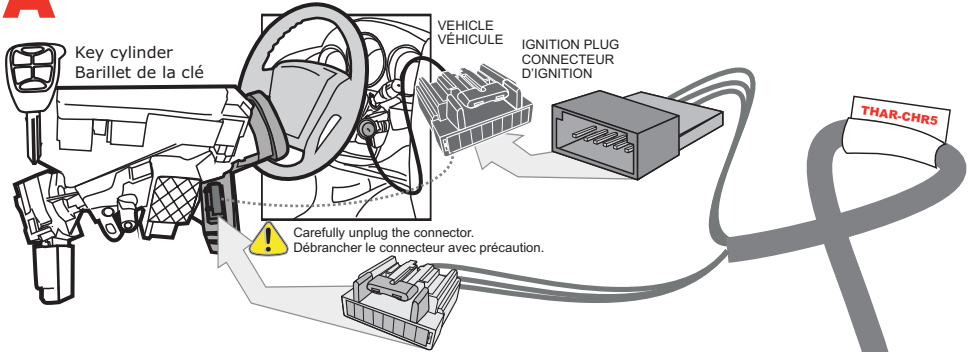

Do not connect in a Jeep Wrangler | Ne pas brancher dans un Jeep Wrangler Purple | Mauve

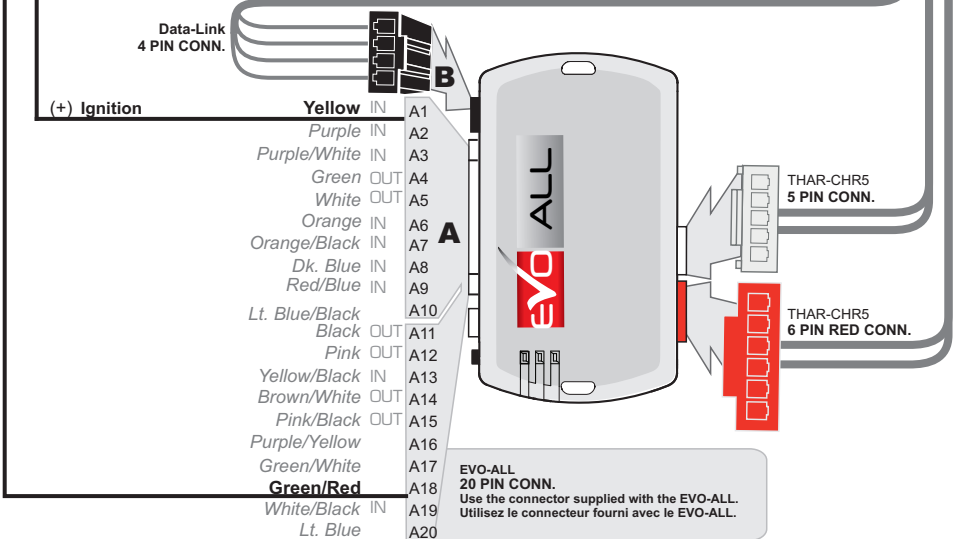
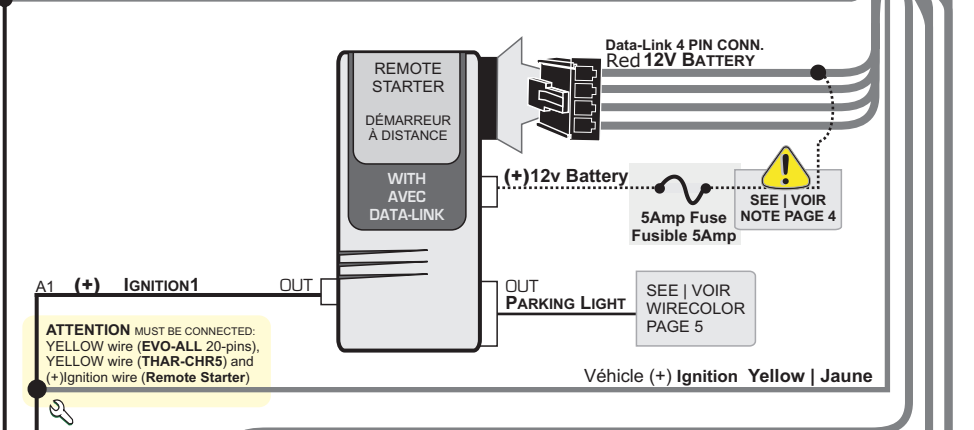

B

INSTALLATION WITHOUT DATA-LINK | INSTALLATION SANS DATA-LINK

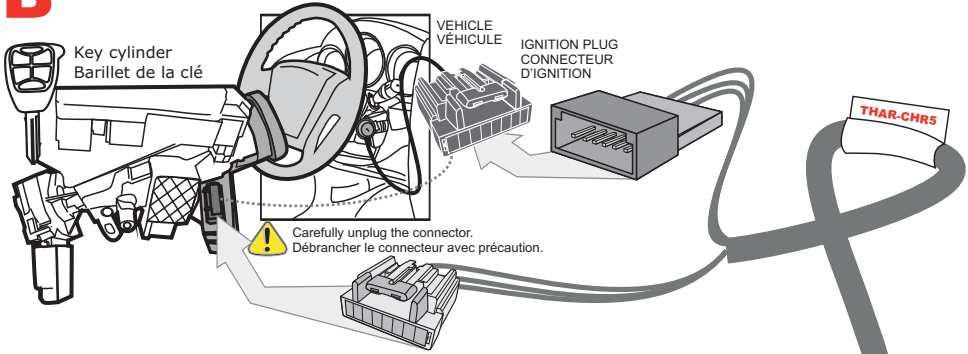

Do not connect in a Jeep Wrangler | Ne pas brancher dans un Jeep Wrangler

Purple | Mauve

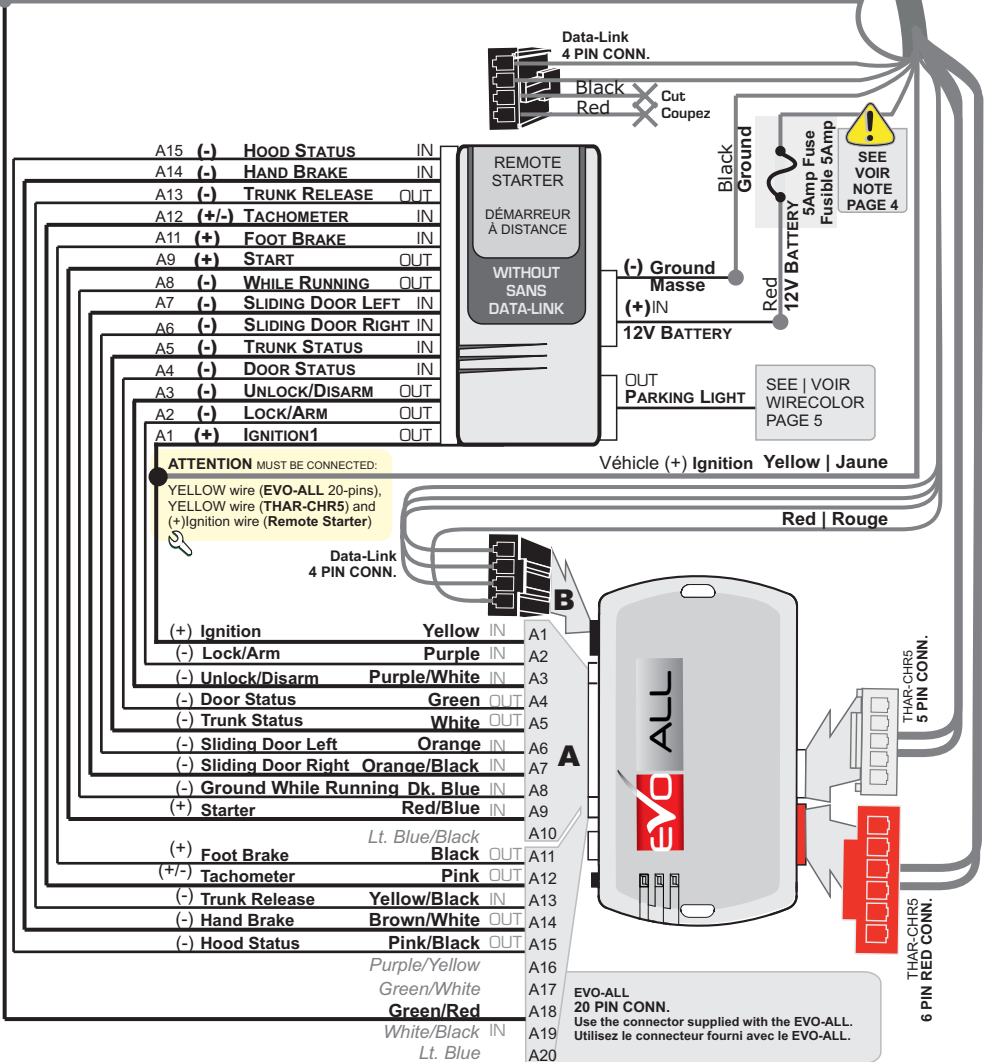

C

STAND ALONE INSTALLATION | INSTALLATION DÉMARREUR AUTONOME

✓15



Configure the EVO-ALL as a Stand Alone Remote Starter: **Connect** the module to the **FlashLink Updater 2** (sold separately) and use the **FlashLink Updater software** to enable option #15 in options menu.

Press the OEM remote's Lock button 3x to remote-start (or remote-stop) the vehicle.

Configurez le EVO-ALL comme un démarreur autonome: **Branchez** le EVO-ALL au **FlashLink Updater 2** (Vendu séparément) et utilisez le **programme FlashLink Updater** pour activer l'option #15 dans le menu Configuration - Options du module.

Appuyez sur le bouton Verrouillage 3X de la télécommande d'origine pour démarrer à distance (ou arrêter à distance) le véhicule.

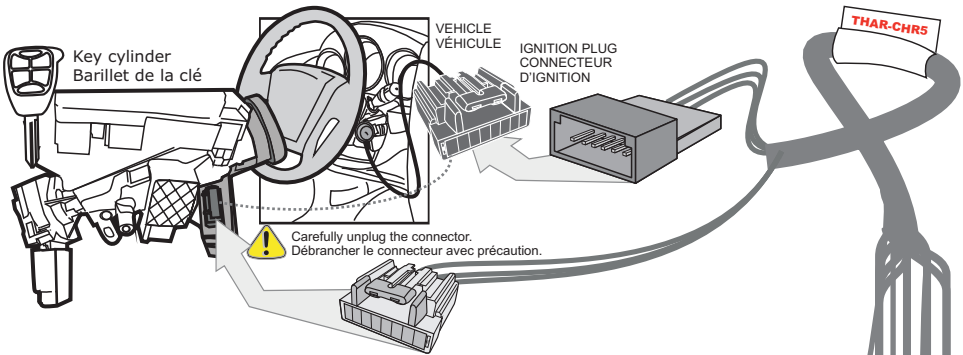

Do not connect in a Jeep Wrangler | Ne pas brancher dans un Jeep Wrangler Purple | Mauve

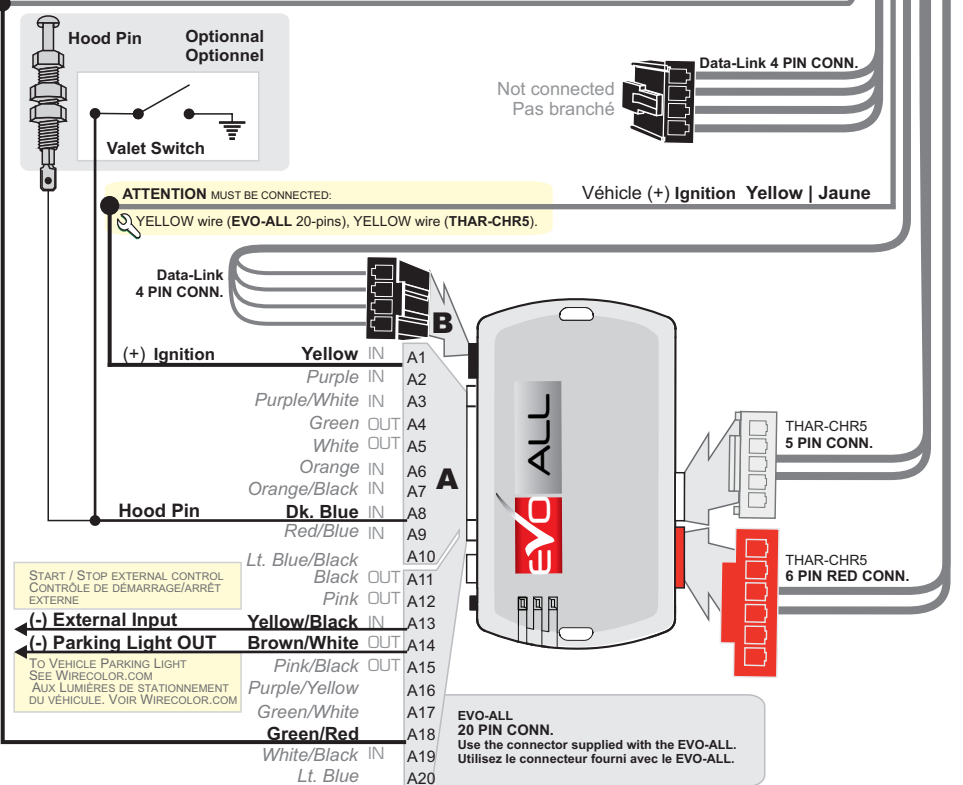

D INSTALLATION WITH DATA-LINK | INSTALLATION AVEC DATA-LINK

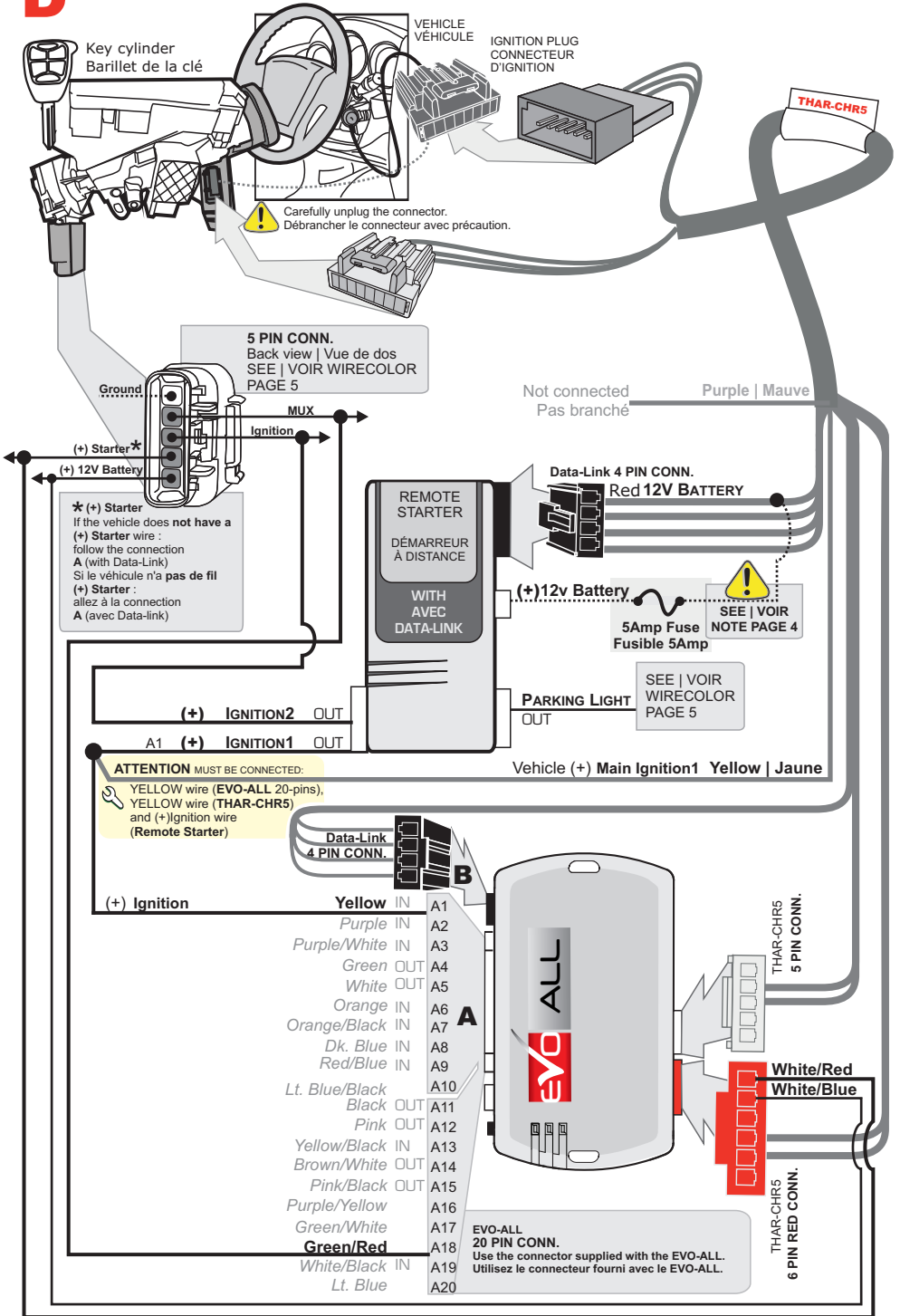

E

INSTALLATION WITHOUT DATA-LINK | INSTALLATION SANS DATA-LINK

Key cylinder
Barillet de la clé

VEHICLE
VÉHICULE

IGNITION PLUG
CONNECTEUR D'IGNITION

5 PIN CONN.
Back view | Vue de dos
SEE | VOIR WIRECOLOR
PAGE 5

Carefully unplug the connector.
Débrancher le connecteur
avec précaution.

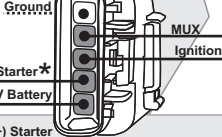

(+) Starter*
(+) 12V Battery

*** (+) Starter**
If the vehicle does not have a
(+) Starter wire :
follow the connection B (without Data-Link)
Si le véhicule n'a pas de fil (+) Starter :
allez à la connection B (sans Data-Link)

Not connected
Pas branché
Purple | Mauve

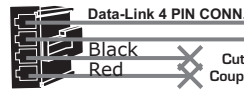

! SEE VOIR NOTE PAGE 4
5amp Fuse
Fusible 5amp

- A15 HOOD STATUS (-) IN
- A14 HAND BRAKE (-) IN
- A13 TRUNK RELEASE (-) OUT
- A12 TACHOMETER (+/-) IN
- A11 FOOT BRAKE (+) IN
- A9 START (+) OUT
- A8 WHILE RUNNING (-) OUT
- A7 SLIDING DOOR LEFT (-) IN
- A6 SLIDING DOOR RIGHT (-) IN
- A5 TRUNK STATUS (-) IN
- A4 DOOR STATUS (-) IN
- A3 UNLOCK/DISARM (-) OUT
- A2 LOCK/ARM (-) OUT
- A1 IGNITION1 (+) OUT

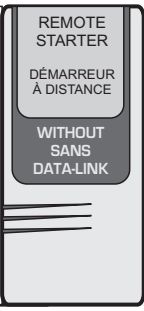

ATTENTION MUST BE CONNECTED:
YELLOW wire (EVO-ALL 20-pins),
YELLOW wire (THAR-CHR5)
and (+)Ignition wire
(Remote Starter)

Vehicle (+) Main Ignition1 Yellow | Jaune



- (+) Ignition Yellow IN A1
- (-) Lock/Arm Purple IN A2
- (-) Unlock/Disarm Purple/White IN A3
- (-) Door Status Green OUT A4
- (-) Trunk Status White OUT A5
- (-) Sliding Door Left Orange IN A6
- (-) Sliding Door Right Orange/Black IN A7
- (-) Ground While Running Dk. Blue IN A8
- (+) Starter Red/Blue IN A9
- (+) Foot Brake Lt. Blue/Black Black OUT A10
- (+/-) Tachometer Pink OUT A11
- (-) Trunk Release Yellow/Black IN A12
- (-) Hand Brake Brown/White OUT A14
- (-) Hood Status Pink/Black OUT A15
- Purple/Yellow A16
- Green/White A17
- Green/Red A18
- White/Black IN A19
- Lt. Blue A20



THAR-CHR5
5 PIN CONN.

White/Red
White/Blue

THAR-CHR5
6 PIN RED
CONN.

**EVO-ALL
20 PIN CONN.**
Use the connector supplied with the EVO-ALL.
Utilisez le connecteur fourni avec le EVO-ALL.

STAND ALONE INSTALLATION | INSTALLATION DÉMARREUR AUTONOME

✔15



3X
LOCK

Configure the EVO-ALL as a Stand Alone Remote Starter: **Connect** the module to the **FlashLink Updater 2** (sold separately) and use the **FlashLink Manager** software to enable option #15 in options menu.
Press the OEM remote's Lock button 3x to remote-start (or remote-stop) the vehicle.

Configurez le EVO-ALL comme un démarreur autonome: **Branchez** le EVO-ALL au **FlashLink Updater 2** (Vendu séparément) et utilisez le **programme FlashLink Manager** pour activer l'option #15 dans le menu Configuration - Options du module.
Appuyez sur le bouton Verrouillage 3X de la télécommande d'origine pour démarrer à distance (ou arrêter à distance) le véhicule.

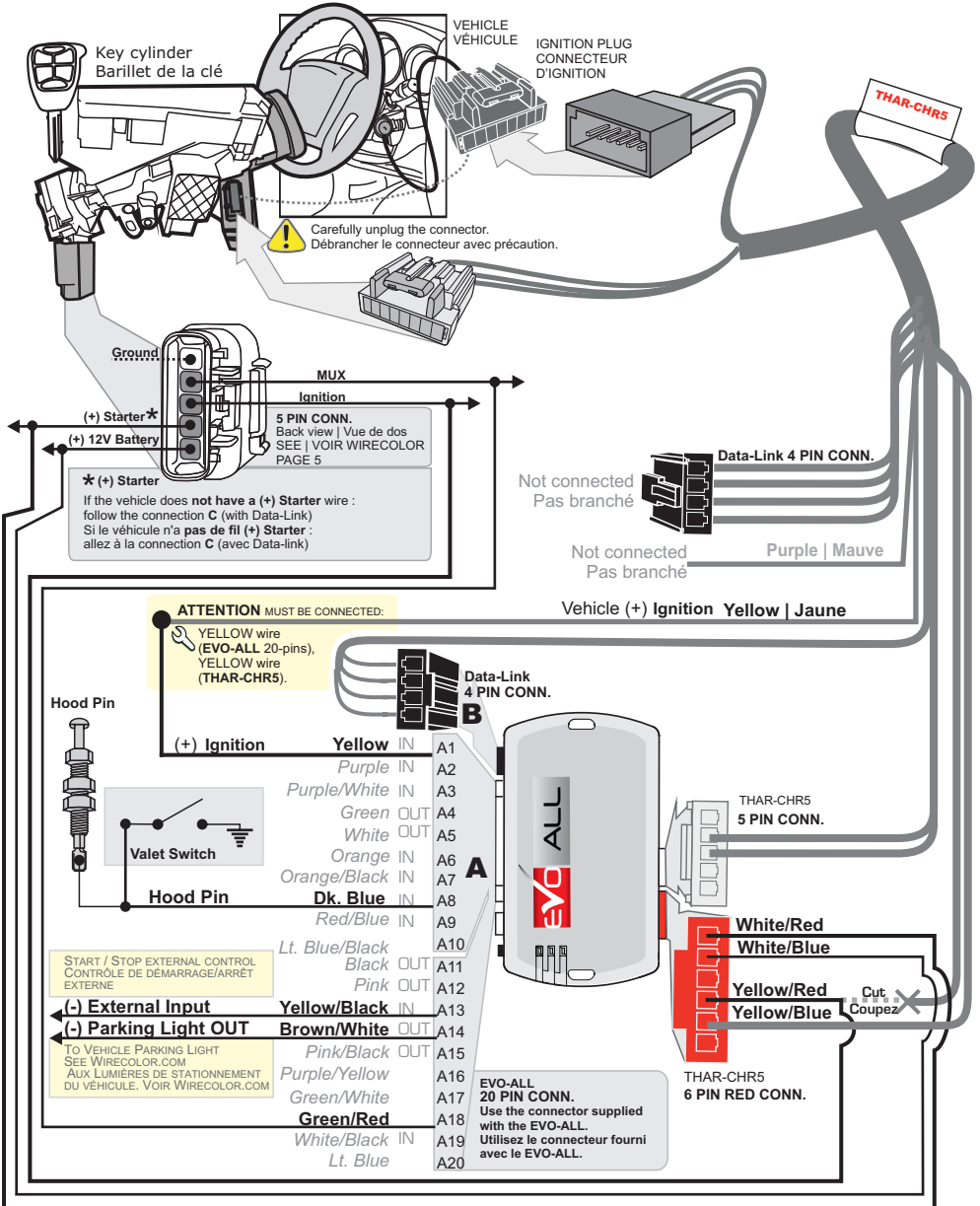

G

INSTALLATION WITH DATA-LINK | INSTALLATION AVEC DATA-LINK

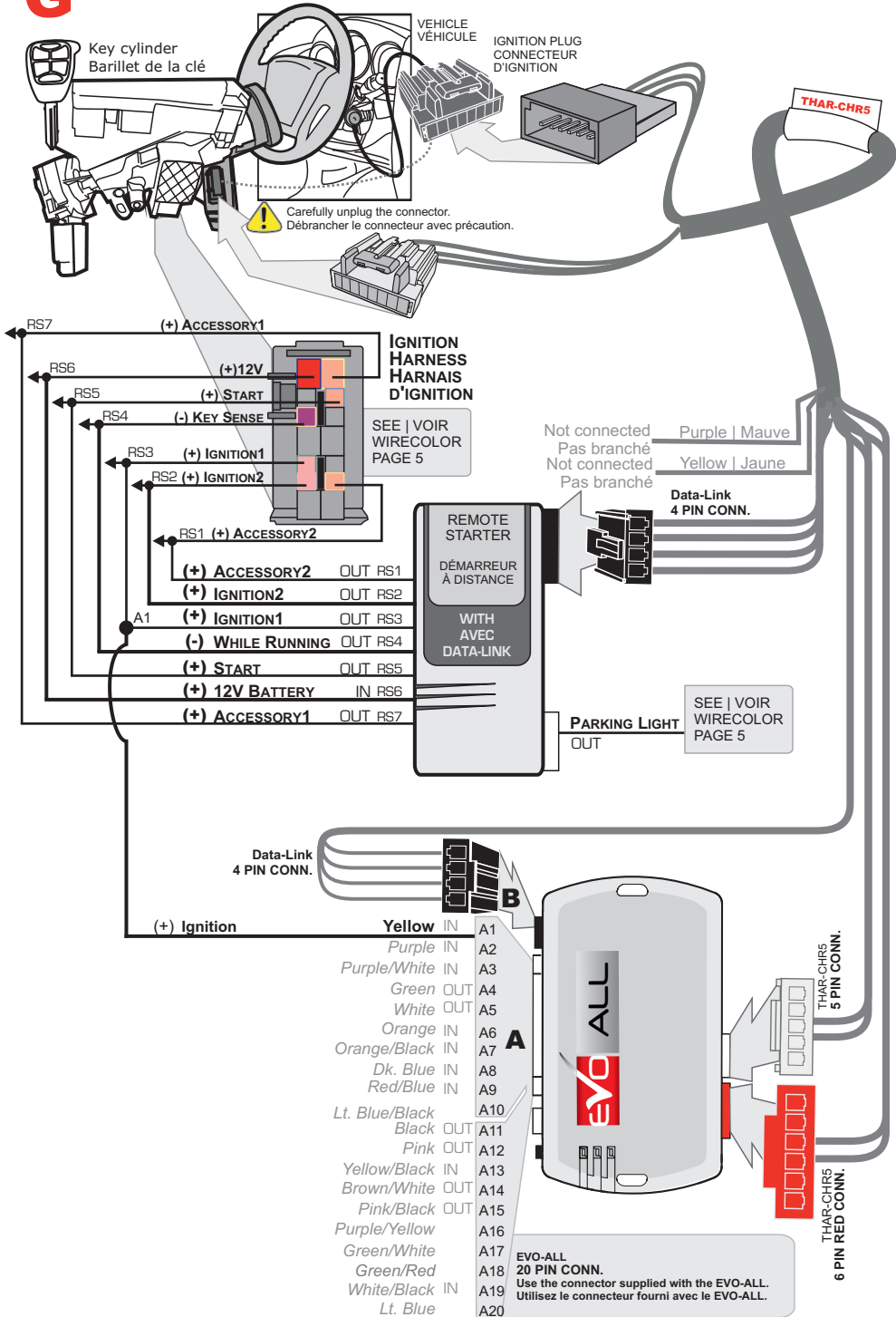





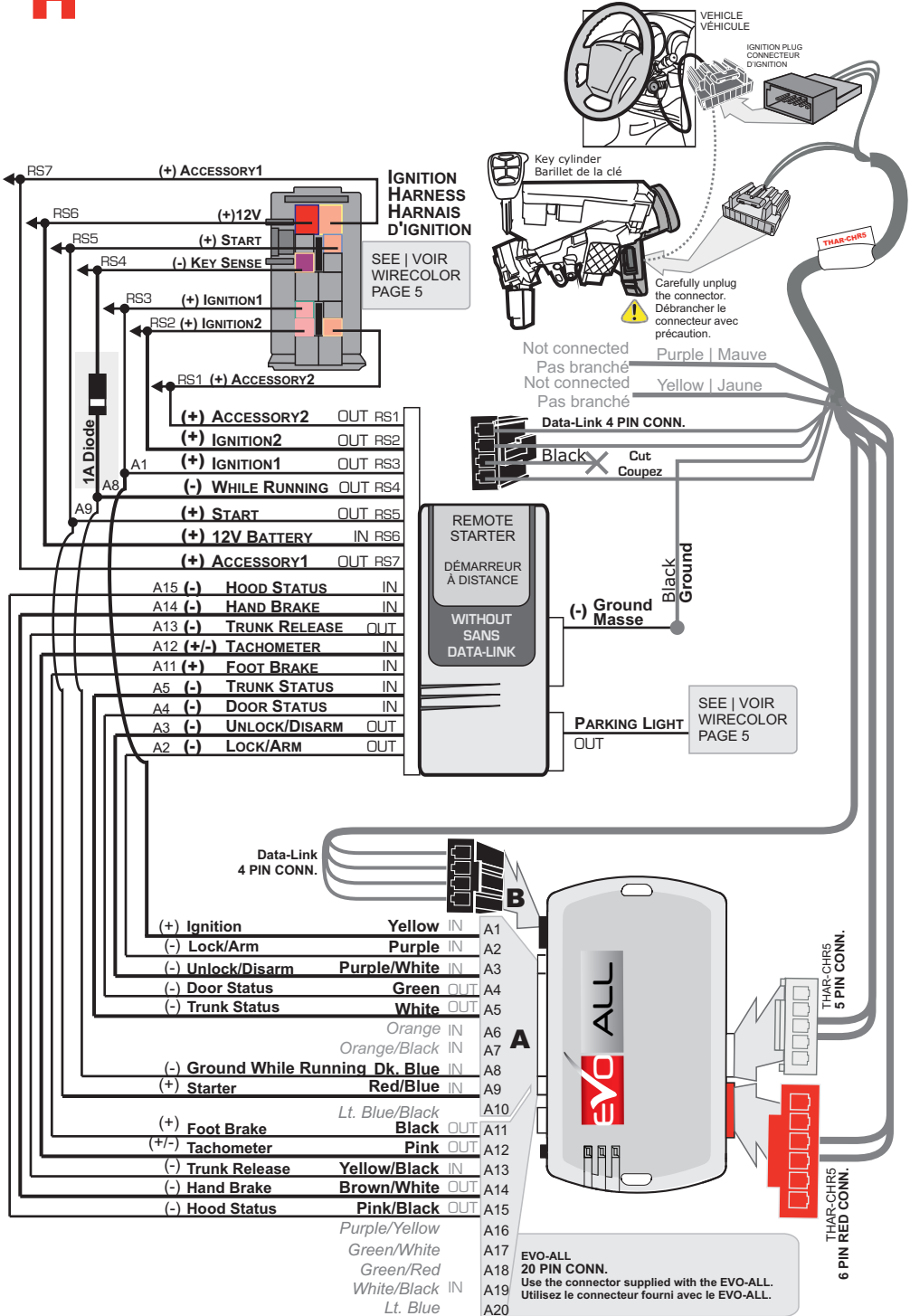

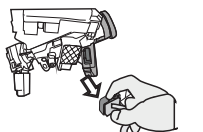
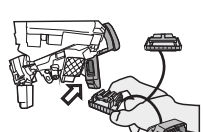
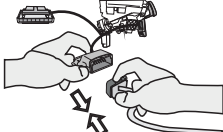

INSTALLATION WITHOUT DATA-LINK | INSTALLATION SANS DATA-LINK

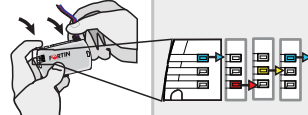
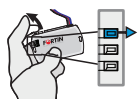
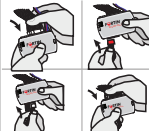

EVO-ALL PROGRAMMING | PROGRAMMATION DU EVO-ALL

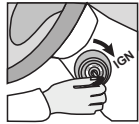
<p>1</p>  <p>Disconnect the immobilizer connector which is located at the key cylinder.</p> <p>Débranchez le connecteur d'immobilisateur situé au barillet de la clé.</p>	<p>2</p>  <p>Connect the male connector of the T-Harness to the immobilizer module.</p> <p>Branchez le connecteur Mâle du Harnais en T dans le module d'immobilisation.</p>	<p>3</p>  <p>Connect the immobilizer connector to the female connector of the T-Harness.</p> <p>Branchez le connecteur d'immobilisateur dans le connecteur femelle du harnais en T</p>	 <p>Make all the remote starter's required connection.</p> <p>Faire tous les branchements requis au démarreur à distance.</p>
--	---	--	--

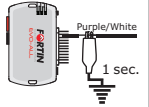
<p>4</p>  <p>Press and hold the programming button:</p> <p>Appuyez et maintenez enfoncé le bouton de programmation:</p>	<p>5</p>  <p>Insert the 4 Pin (Data-Link) connector.</p> <p>Insérez le connecteur 4 pins (Data-Link).</p>	<p>6</p>  <p>Release the programming button when the LED is BLUE.</p> <p>Relâchez le bouton de programmation quand la DEL est BLEU</p>	<p>7</p> <p>If the LED is not solid BLUE disconnect the 4 Pin connector (Data-Link) and go back to beginning of step 1. Si la DEL n'est pas BLEU solide débranchez le connecteur 4 pins (Data-Link) et allez au début de l'étape 1.</p>  <p>Insert the required remaining connectors: 20 pin (White), 5 pin (White), 6 pin (Red), 2 pin (White).</p> <p>Insérez les connecteurs requis restants: 20 pins (Blanc), 2 pins (Blanc), 5 pins (Blanc), 6 pins (Rouge)</p>
--	---	--	---

<p>8</p>  <p>Turn the Ignition to the ON/RUN position.</p> <p>Tournez la clef en position Ignition (ON).</p>	<p>9</p> <p>Flash </p> <p>The BLUE LED will flash rapidly.</p> <p>La DEL BLEU clignotera rapidement.</p>	<p>10 Vehicles with OEM alarm / Véhicule avec alarme d'origine</p> <p>Or Ou Or Ou</p> <div style="display: flex; justify-content: space-between;"> <div style="width: 45%;">  <p>Press the unlock button on the remote car starter remote control.</p> <p>Appuyez sur le bouton déverrouillage de la télécommande du démarreur.</p> </div> <div style="width: 45%;">  <p>Ground the Purple/White wire of the 20-pin connector for 1 second.</p> <p>Mettez à la masse le fil Mauve/Blanc du connecteur 20 pins pour 1 seconde.</p> </div> </div> <div style="text-align: right; margin-top: 10px;">  <p>Enable option #12 using the FlashLink Manager.</p> <p>Activez l'option #12 avec le FlashLink Manager.</p> </div>
--	---	--

<p>11</p>  <p>Turn the Ignition to the OFF position.</p> <p>Tournez la clef à OFF.</p>	<p>12</p> <p>Flash </p> <p>The BLUE LED will flash rapidly.</p> <p>La DEL BLEU clignotera rapidement.</p>	<p>13</p> <p>Flash  Off</p> <p>The BLUE LED will turn off.</p> <p>La DEL BLEU s'éteint.</p>	<p>14</p>  <p>The module is now programmed.</p> <p>Le module est programmé.</p>
---	--	--	--

*Parts required (not included)
*Pièces requises (non incluses)

F**RTIN**

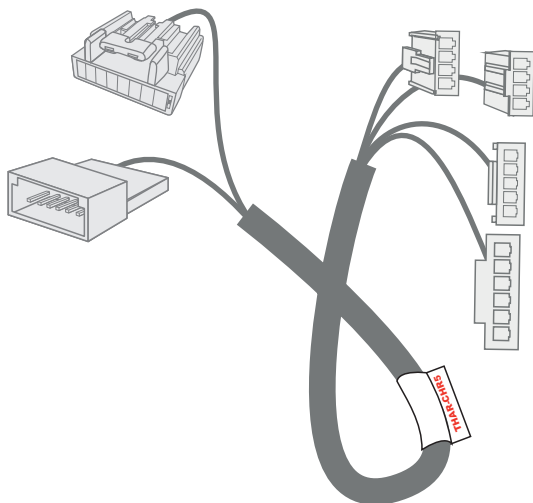

TECHNICAL SUPPORT / INFORMATION

Neither the manufacturer or distributor of this module is responsible for damages of any kind either indirectly or directly caused by this module, except for the replacement of this module in case of manufacturing defects. This module must be installed by a qualified technician.

This instruction guide may change without notice. Visit www.fortinbypass.com to obtain the latest version.

INFORMATIONS / SUPPORT TECHNIQUE

Ni le fabricant, ni le distributeur ne se considèrent responsables des dommages causés ou ayant pu être causés, indirectement ou directement, par ce module, excepté le remplacement de ce module en cas de défectuosité de fabrication. Ce module doit être installé par un technicien qualifié.

Ce guide d'instruction peut faire l'objet de changement sans préavis. Consultez le www.fortinbypass.com pour voir la plus récente version.

www.fortinbypass.com



TECHNICAL SUPPORT
Tél: 514-255-HELP (4357)
1-877-336-7797



INSTALLATION GUIDE

