

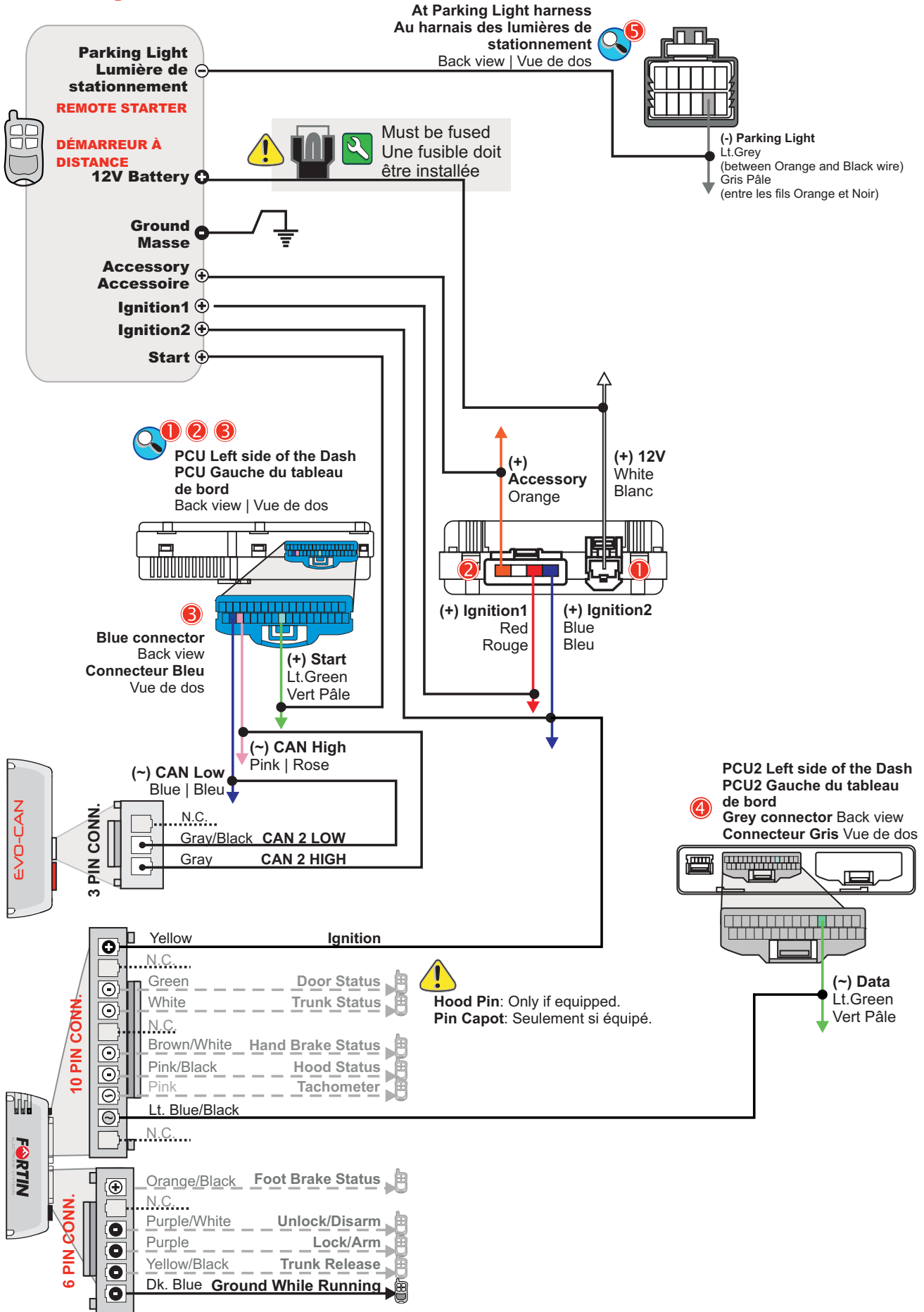

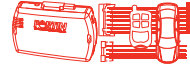







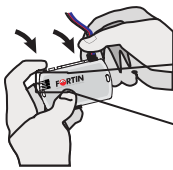
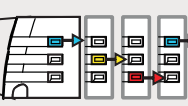
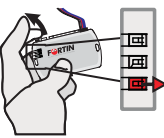

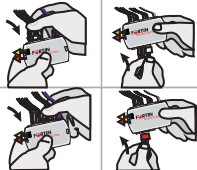

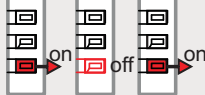

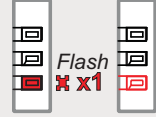

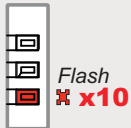
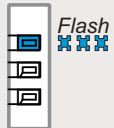

TL CONTINUED | SUITE



PROGRAMMING PROCEDURE | PROCÉDURE DE PROGRAMMATION

<p>1</p>  <p>Press and hold the programming button:</p> <p>Appuyez et maintenez enfoncé le bouton de programmation:</p>	 <p>Insert the 4 Pin (Data-Link) connector.</p> <p>Insérez le connecteur 4 pins (Data-Link).</p>	 <p>The LED will alternate between BLUE, YELLOW and RED flashes. Les DELS alternent entre un flash BLEU, JAUNE et ROUGE.</p>	 <p>Release the programming button when the LED is RED</p> <p>Relâchez le bouton de programmation quand la DEL est ROUGE</p>	<p>▶▶▶</p> <p>If the LED is not solid RED disconnect the 4 Pin connector (Data-Link) and go back to beginning of step 1. Si le DEL n'est pas ROUGE solide débranchez le connecteur 4 pins (Data-Link) et allez au début de l'étape 1.</p> 	<p>2</p>  <p>Insert the required remaining connectors:</p> <p>10 pin (White), 2 pin (White), 6 pin (White), 6 pin (Red), 3 pin (White)</p> <p>Insérez les connecteurs requis restants:</p> <p>10 pins (Blanc), 2 pins (Blanc), 6 pins (Blanc), 6 pins (Rouge), 3 pins (Blanc).</p>
<p>3</p>  <p>Press the programming button once (1x).</p> <p>Appuyez et relâchez 1 fois le bouton de programmation.</p>	 <p>The RED LED will turn OFF and turn back ON.</p> <p>La DEL ROUGE s'éteint et se rallume.</p>	<p>4</p>  <p>Press the programming button once (1x).</p> <p>Appuyez et relâchez 1 fois le bouton de programmation.</p>	 <p>The RED LED will flash 1 once every second.</p> <p>La DEL ROUGE clignote 1 fois chaque seconde.</p>	<p>5</p>  <p>Press the Push-to-Start button twice to turn on the ignition. (Do not press the brake pedal)</p> <p>Appuyez 2 fois sur le bouton démarrage (Push-to-Start) pour allumer l'ignition. (Ne pas appuyer sur la pédale de frein)</p>	
 <p>The Red LED will flash 10 times, Key bypass : programming complete. La DEL Rouge clignote 10 fois : Contournement de clé: programmation complété.</p>	 <p>Once the Blue LED starts to flash rapidly: Lorsque la DEL Bleu clignote rapidement:</p>	<p>6</p>  <p>press the Push-to-Start button once to shut off the ignition.</p> <p>appuyez une fois sur le bouton démarrage (Push-to-Start) pour éteindre l'ignition.</p>	 <p>The LED will turn off. Le DEL s'éteint.</p>	 <p>The module is now programmed. Le module est programmé.</p> <p>Use the remote of the remote starter or security system to test all of the supported features to ensure proper programming. Testez toutes les fonctions supportées sur le véhicule avec la télécommande du démarreur à distance ou du système de sécurité.</p>	

REMOTE STARTER FUNCTIONALITY | FONCTIONNALITÉS DU DÉMARREUR À DISTANCE

 <p>All doors must be closed. Toutes les portes doivent être fermées</p>	 <p>Remote start the vehicle. Démarrez à distance.</p>	 <p>The module will shut down the vehicle as soon as the drivers door is opened. Lors de l'ouverture de la porte conducteur le véhicule s'éteindra par sécurité.</p>	 <p>Enter the vehicle with the Smart-Key. Entrez dans le véhicule avec la clé intelligente (Smart-Key) sur vous</p>	 <p>Press the brake pedal. Appuyez sur la pédale de frein</p>	 <p>Press the Push-to-Start button once. Appuyez 1 fois sur le bouton démarrage (Push-to-Start).</p>	 <p>The vehicle can now be put in to gear and driven. Vous êtes maintenant prêt à embrayer et prendre la route.</p>
---	---	---	--	---	---	--

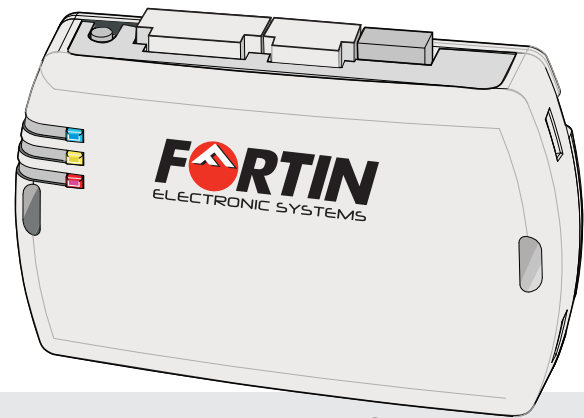

Module label | Étiquette sur le module

Notice: Updated Firmware and Installation Guides

Updated firmware and installation guides are posted on our web site on a regular basis. We recommend that you update this module to the latest firmware and download the latest installation guide(s) prior to the installation of this product.

Des mises à jour du Firmware (microprogramme) et des guides d'installation sont mis en ligne régulièrement. Vérifiez que vous avez bien la dernière version logiciel et le dernier guide d'installation avant l'installation de ce produit.

WARNING / TECH SUPPORT / MISE EN GARDE / SUPPORT TECHNIQUE

The information on this sheet is provided on an (as is) basis with no representation or warranty of accuracy whatsoever. It is the sole responsibility of the installer to check and verify any circuit before connecting to it. Only a computer safe logic probe or digital multimeter should be used. FORTIN ELECTRONIC SYSTEMS assumes absolutely no liability or responsibility whatsoever pertaining to the accuracy or currency of the information supplied. The installation in every case is the sole responsibility of the installer performing the work and FORTIN ELECTRONIC SYSTEMS assumes no liability or responsibility whatsoever resulting from any type of installation, whether performed properly, improperly or any other way. Neither the manufacturer or distributor of this module is responsible of damages of any kind indirectly or directly caused by this module, except for the replacement of this module in case of manufacturing defects. This module must be installed by qualified technician. The information supplied is a guide only. This instruction guide may change without notice. **Visit www.fortinbypass.com to get the latest version.**

L'information de ce guide est fournie sur la base de représentation (telle quelle) sans aucune garantie de précision et d'exactitude. Il est de la seule responsabilité de l'installateur de vérifier tous les fils et circuit avant défectuer les connections. Seule une sonde logique ou un multimètre digital doivent être utilisés. FORTIN SYSTÈMES ÉLECTRONIQUES n'assume aucune responsabilité de l'exactitude de l'information fournie. L'installation (dans chaque cas) est la responsabilité de l'installateur effectuant le travail. FORTIN SYSTÈMES ÉLECTRONIQUES n'assume aucune responsabilité suite à l'installation, que celle-ci soit bonne ou mauvaise ou de n'importe autre type. Ni le fabricant, ni le distributeur ne se considèrent responsables des dommages causés ou ayant pu être causés, indirectement ou directement, par ce module, excepté le remplacement de ce module en cas de défectuosité de fabrication. Ce module doit être installé par un technicien qualifié. L'information fournie dans ce guide est une suggestion. Ce guide d'instruction peut faire l'objet de changement sans préavis. **Consultez le www.fortinbypass.com pour voir la plus récente version.**

Copyright © 2006-2012, FORTIN AUTO RADIO INC ALL RIGHTS RESERVED **PATENT PENDING**



TECH SUPPORT

Tél: 514-255-HELP (4357)
1-877-336-7797



ADDENDUM GUIDE

www.fortinbypass.com
WEB UPDATE | MISE À JOUR INTERNET

