

**ADDENDUM - SUGGESTED WIRING CONFIGURATION  
SCHEMA DE BRANCHEMENT SUGGERE**

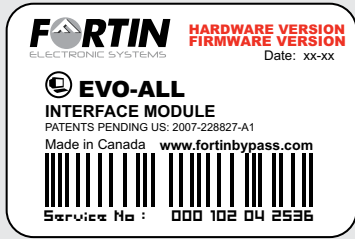

VEHICLE   VEHICULES	YEARS ANNÉES	Functional if equipped   Fonctionnelle si le véhicule en est équipé.																										See legend	
		Lock	Unlock	Arm	Disarm	Hatch (open)	Trunk (open)	Sliding Door	Window Roll Down	Gas Door	RAP Disable	Parking Light	Memory Driver	Tachometer	Defrost	Heated Seats	Heated Mirrors	Rear Defrost	Door Status	Trunk Status	Hood Status	Hand-Brake Status	Foot-Brake Status	Transponder Bypass	PK3, Passlock	Key Control	Activate OEM Remote Start		Push-to-Start Control
NISSAN		A	B	C	D	E	F	G	H	I	J	K	L	M	N	O	P	Q	R	S	T	U	V	W	X	Y	Z	ZA	
Frontier	2008-2011	•	•																										
Quest	2008-2009	•	•				•																						
Titan	2008-2011	•	•				•																						
XTerra	2008-2011	•	•				•																						



Module label | Étiquette sur le module

**Notice: Updated Firmware and Installation Guides**

Updated firmware and installation guides are posted on our web site on a regular basis. We recommend that you update this module to the latest firmware and download the latest installation guide(s) prior to the installation of this product.

Des mises à jour du Firmware (microprogramme) et des guides d'installation sont mises en ligne régulièrement. Vérifiez que vous avez bien la dernière version logiciel et le dernier guide d'installation avant l'installation de ce produit.

**WARNING / TECH SUPPORT / MISE EN GARDE / SUPPORT TECHNIQUE**

The information on this sheet is provided on an (as is) basis with no representation or warranty of accuracy whatsoever. It is the sole responsibility of the installer to check and verify any circuit before connecting to it. Only a computer safe logic probe or digital multimeter should be used. FORTIN Electronic system assumes absolutely no liability or responsibility whatsoever pertaining to the accuracy or currency of the information supplied. The installation in every case is the sole responsibility of the installer performing the work and FORTIN Electronic system assumes no liability or responsibility whatsoever resulting from any type of installation, whether performed properly, improperly or any other way. Neither the manufacturer or distributor of this module is responsible of damages of any kind indirectly or directly caused by this module, except for the replacement of this module in case of manufacturing defects. This module must be installed by qualified technician. The information supplied is a guide only. This instruction guide may change without notice. Visit [www.ifar.ca](http://www.ifar.ca) to get latest version.

L'information de ce guide est fournie sur la base de représentation (telle quelle) sans aucune garantie de précision et d'exactitude. Il est de la seule responsabilité de l'installateur de vérifier tous les fils et circuit avant de effectuer les connexions. Seule une sonde logique ou un multimètre digital doivent être utilisés. FORTIN Electronic systems n'assume aucune responsabilité de l'exactitude de l'information fournie. L'installation (dans chaque cas) est la responsabilité de l'installateur effectuant le travail. FORTIN Electronic system n'assume aucune responsabilité suite à l'installation, que celle-ci soit bonne ou mauvaise ou de n'importe autre type. Ni le fabricant, ni le distributeur ne se considèrent responsables des dommages causés ou ayant pu être causés, indirectement ou directement, par ce module, excepté le remplacement de ce module en cas de défectuosité de fabrication. Ce module doit être installé par un technicien qualifié. L'information fournie dans ce guide est une suggestion. Ce guide d'instruction peut faire l'objet de changement sans préavis. Consultez le [www.ifar.ca](http://www.ifar.ca) pour voir la plus récente version.

Copyright © 2006-2011, FORTIN AUTO RADIO INC ALL RIGHTS RESERVED PATENTE PENDING



**TECH SUPPORT**  
Tél: 514-255-HELP (4357)  
1-877-336-7797



**ADDENDUM GUIDE**

**www.fortinbypass.com**  
WEB UPDATE | MISE À JOUR INTERNET



**NISSAN FRONTIER, QUEST, TITAN, XTERRA**

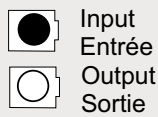

Connection always **required**  
Branchement toujours **requis**

Connection **not required** with Data-link  
Branchement **non requis** avec Data-Link

Connect to vehicle  
Branchement au véhicule  
Connect to Remote-Starter/Alarm  
Branchement au démarreur à distance/Alarme

**INSTALLATION WITH DATA-LINK  
INSTALLATION AVEC DATA-LINK**

Remote Starter/Alarm with the **Fortin Data-link protocol**.  
Démarreur à distance/alarme avec le **protocole Data-link Fortin**

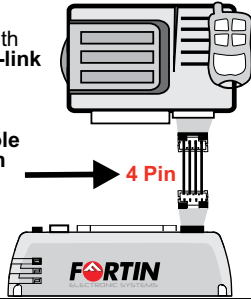

**INSTALLATION WITHOUT DATA-LINK  
INSTALLATION SANS DATA-LINK**

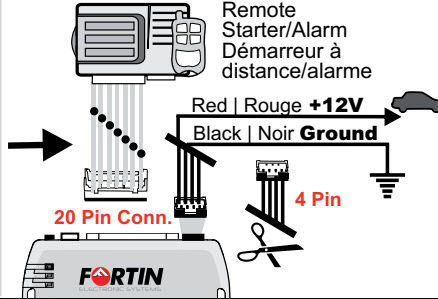

- 1 Cut off one plug of the 4 Pin Data-Link connector
- 2 Connect the Red wire to +12V
- 3 Connect the Black wire to Ground

- 1 Coupez l'extrémité du connecteur 4 pins Data-Link
- 2 Connectez le fil rouge au 12V
- 3 Connectez le fil noir à la masse du véhicule.

**WARNING:** On 2008 and newer vehicles (regular key & Turn button) a **relay is required** in the engine compartment in order to prevent permanent damage to the vehicle. See <http://www.ifar.ca> for more information. | **ATTENTION :** Sur les véhicules 2008 et plus (clé régulière et Bouton Rotatif) l'**installation d'un relais** sous le capot est requise pour prévenir des dommages permanents au véhicule. Voir [www.ifar.ca](http://www.ifar.ca) pour plus d'informations.

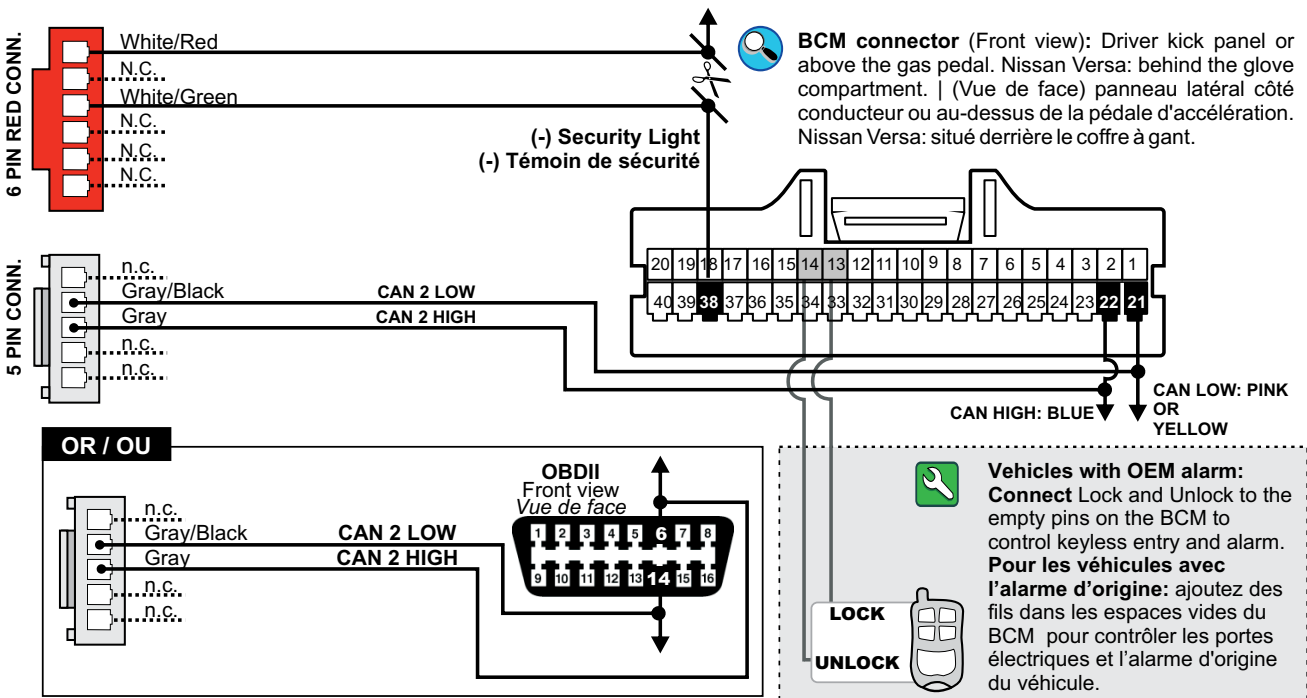
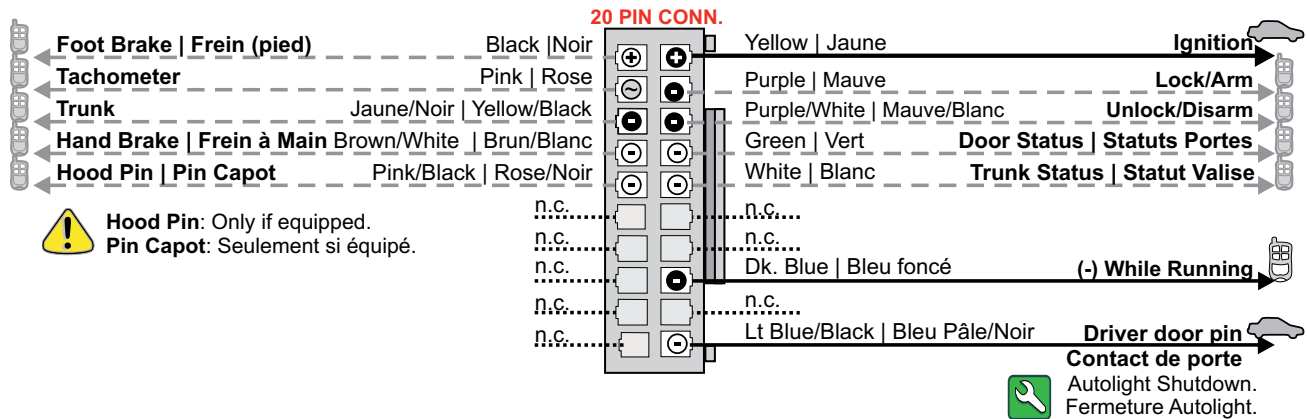

**NISSAN FRONTIER, TITAN, XTERRA CONTINUED | SUITE (QUEST SEE NEXT PAGE)**

NISSAN	Starter 1	Starter 2	(+) Neutral Safety Switch
Frontier Titan	GRAY   GRIS	WHITE   BLANC	RED   ROUGE
XTerra	WHITE   BLANC	GRAY   GRIS	RED   ROUGE



**CAUTION:** Permanent damage can be done to the starter if this relay is not installed.  
**ATTENTION:** Des dommages permanents peuvent être causés au démarreur si ce relai n'est pas installé..



**Voltage Test: (3 states) / Test de voltage: 3 états**  
 Key OFF: 0 Volts / Clé OFF: 0 Volts  
 Key ON, Transmission in Park: 12 Volts / Clé ON Embreyage a Park 12 Volts  
 Key ON, Transmission in Drive: 0 Volts / Clé On Embreyage a Drive: 0 Volts

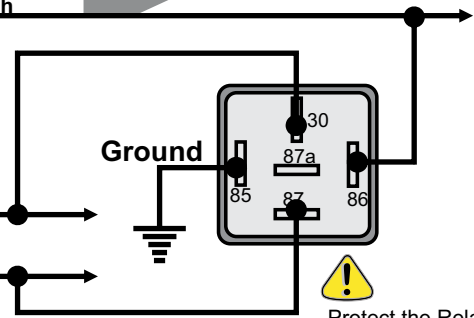
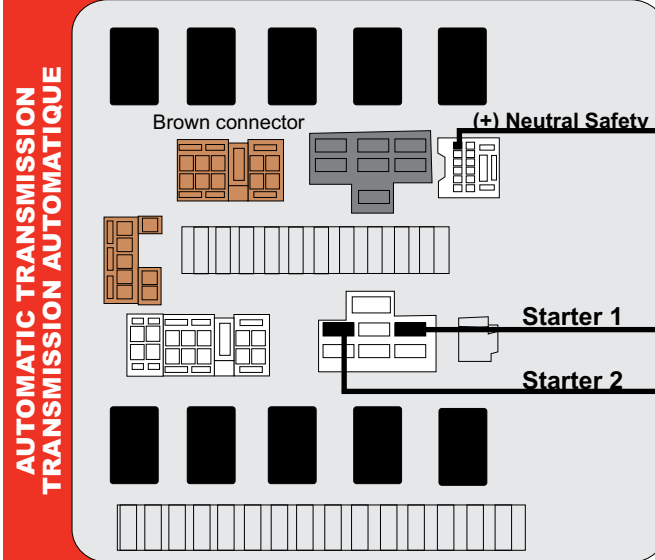

Protect the Relay from moisture otherwise damage may occur.  
Protégez le Relai des intempéries. L'eau peut causer des dommages.



**IPDM-E/R**  
engine compartment.  
or Driver side engine compartment.  
Sous le capot ou sous le capot côté conducteur.



**REMOTE STARTER / DÉMARREUR À DISTANCE**

Starter 1

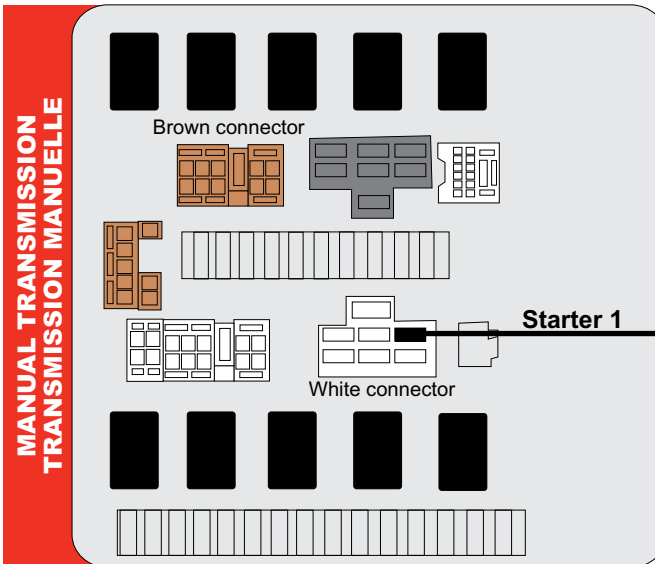

**IPDM-E/R**



**IPDM-E/R**



or | ou



NISSAN QUEST- CONTINUED | SUITE



**CAUTION:** Permanent damage can be done to the starter if this relay is not installed.  
**ATTENTION:** Des dommages permanents peuvent être causés au démarreur si ce relai n'est pas installé.

**AUTOMATIC TRANSMISSION  
TRANSMISSION AUTOMATIQUE**

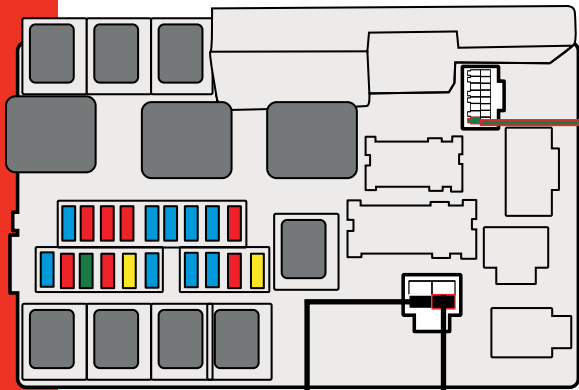

**Voltage Test: (3 states) / Test de voltage: 3 états**  
 Key OFF: 0 Volts / Clé OFF: 0 Volts  
 Key ON, Transmission in Park: 12 Volts / Clé ON Embreyage a Park 12 Volts  
 Key ON, Transmission in Drive: 0 Volts / Clé On Embreyage a Drive: 0 Volts

(+) Neutral Safety Switch  
GREEN/RED  
VERT/ROUGE

**Starter 1**  
BLACK/WHITE  
NOIR/BLANC

**Starter 2**  
BLACK/RED  
NOIR/ROUGE

Ground

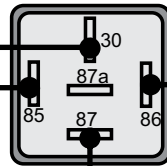

Protect the Relay from moisture otherwise damage may occur.  
Protégez le Relai des intempéries. L'eau peut causer des dommages.



**IPDM-E/R**  
engine compartment.  
or Driver side engine compartment.  
Sous le capot  
ou sous le capot côté conducteur.

**MANUAL TRANSMISSION  
TRANSMISSION MANUELLE**

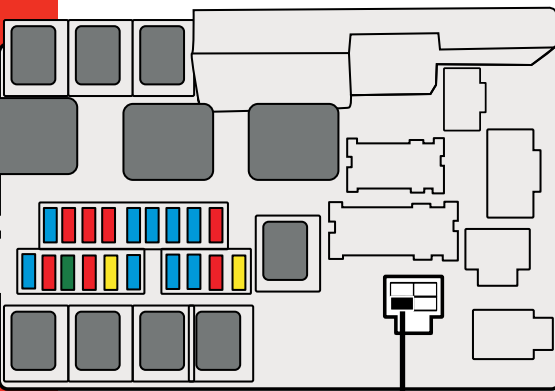





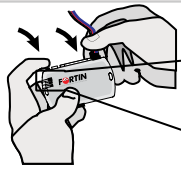
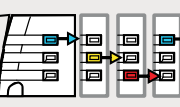

**Starter 1**  
BLACK/WHITE  
NOIR/BLANC

**IPDM-E/R**

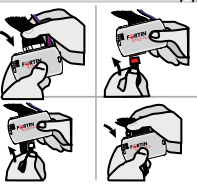

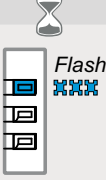
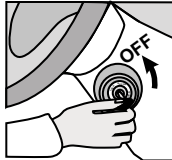
**PROGRAMMING PROCEDURE | PROCÉDURE DE PROGRAMMATION**

<p><b>1</b></p>  <p><b>Press and hold</b> the programming button:</p> <p><b>Appuyez et maintenir enfoncé</b> le bouton de programmation:</p>	 <p><b>Insert</b> the 4 Pin (Data-Link) connector.</p> <p><b>Insérez</b> le connecteur 4 pins (Data-Link).</p>	 <p><i>The LED will alternate between BLUE, YELLOW and RED flashes. Les DELS alternent entre un flash BLEU, JAUNE et ROUGE.</i></p>	 <p><b>Release</b> the programming button when the LED is <b>BLUE</b>.</p> <p><b>Relâchez</b> le bouton de programmation quand la DEL est <b>BLEU</b>.</p>	<p><b>▶▶▶</b></p> <p>If the LED is not solid BLUE disconnect the 4 Pin connector (Data-Link) and go back to beginning of step 1.   Si le DEL n'est pas BLEU solide débranchez le connecteur 4 pins (Data-Link) et allez au début de l'étape 1.</p> 	<p><b>2</b></p>  <p><b>Insert</b> the required remaining connectors: 20 pin (White), 5 pin (White), 6 pin (Red), 2 pin (White).</p> <p><b>Insérez</b> les connecteurs requis restants: 20 pins (Blanc), 2 pins (Blanc), 5 pins (Blanc), 6 pins (Rouge)</p>
<p><b>3</b></p>  <p><b>Turn</b> the Ignition to the ON/RUN position.</p> <p><b>Tournez</b> la clef en position <b>ignition (ON)</b>.</p>	 <p><i>The BLUE LED will flash rapidly. La DEL BLEU clignotera rapidement.</i></p>	 <p><b>Turn</b> the Ignition to the OFF position.</p> <p><b>Tournez</b> la clef à OFF.</p>	 <p><i>The BLUE LED will turn off. Le DEL BLEU s'éteint.</i></p>	 <p><i>The module is now programmed. Le module est programmé.</i></p>	