



SATURN Astra

2008-2009



CAN-SL2

Made in Canada Rev. A - 14 / 01 / 2009
Web site: <http://www.ifar.ca>

ALARM AND REMOTE STARTER CAN BUS INTERFACE KIT

Fonctionnal if equipped

- | | | | |
|--|---|---|--|
| <input checked="" type="checkbox"/> Lock | <input checked="" type="checkbox"/> Tach | <input type="checkbox"/> Radio Off | <input type="checkbox"/> Heat Seats |
| <input checked="" type="checkbox"/> Unlock | <input checked="" type="checkbox"/> Start Enable | <input type="checkbox"/> Transponder Bypass | <input type="checkbox"/> Gas Door |
| <input checked="" type="checkbox"/> Arm | <input checked="" type="checkbox"/> Door Trigger | <input type="checkbox"/> PK3, Passlock | <input checked="" type="checkbox"/> Window Roll Down |
| <input checked="" type="checkbox"/> Disarm | <input checked="" type="checkbox"/> Trunk Trigger | <input type="checkbox"/> Sliding Door | <input type="checkbox"/> Hatch |
| <input type="checkbox"/> Trunk | <input type="checkbox"/> Hood Trigger | <input type="checkbox"/> Defrost | <input type="checkbox"/> Brake Signal |

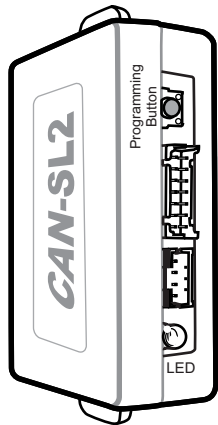

Front view of the module

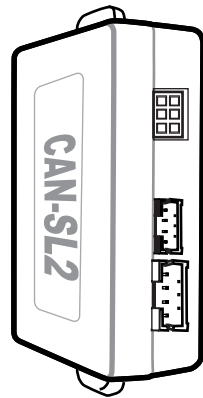

Back of the module

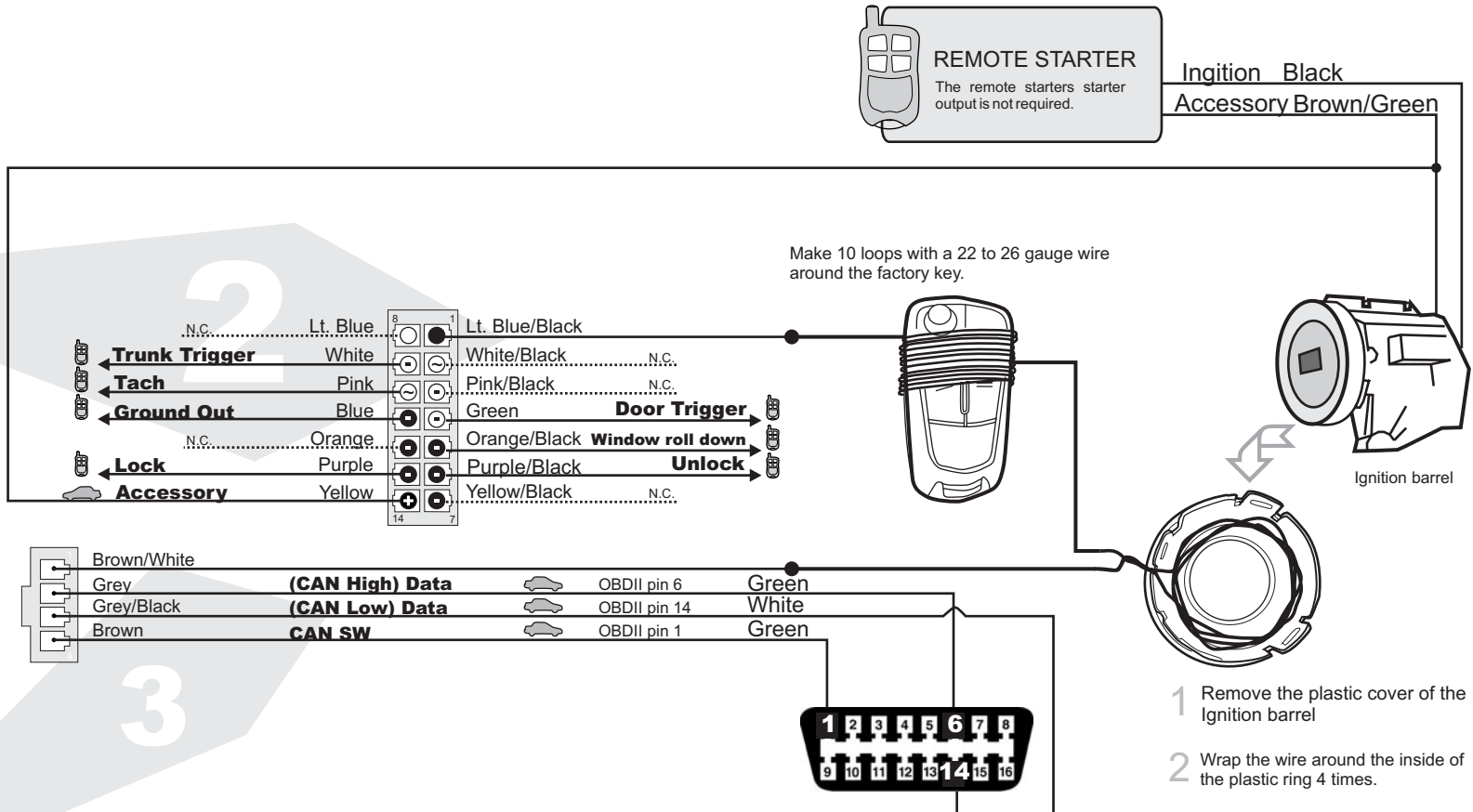

Connect wire to Remote-Starter/Alarm Connect wire to vehicle

OUTPUT INPUT

Connect: Branchez:

Lt. Blue	<input checked="" type="checkbox"/>	Lt. Blue/Black	<input checked="" type="checkbox"/>
White	<input checked="" type="checkbox"/>	White/Black	<input checked="" type="checkbox"/>
Pink	<input checked="" type="checkbox"/>	Pink/Black	<input checked="" type="checkbox"/>
Blue	<input checked="" type="checkbox"/>	Green	<input checked="" type="checkbox"/>
Orange	<input checked="" type="checkbox"/>	Orange/Black	<input checked="" type="checkbox"/>
Purple	<input checked="" type="checkbox"/>	Purple/Black	<input checked="" type="checkbox"/>
Yellow	<input checked="" type="checkbox"/>	Yellow/Black	<input checked="" type="checkbox"/>

Data-Link (1 way)

	<input checked="" type="checkbox"/>
Brown/White	<input checked="" type="checkbox"/>
Grey	<input checked="" type="checkbox"/>
Grey/Black	<input checked="" type="checkbox"/>
Brown	<input checked="" type="checkbox"/>

Connect: Branchez:

Lt. Blue	<input checked="" type="checkbox"/>	Lt. Blue/Black	<input checked="" type="checkbox"/>
White	<input checked="" type="checkbox"/>	White/Black	<input checked="" type="checkbox"/>
Pink	<input checked="" type="checkbox"/>	Pink/Black	<input checked="" type="checkbox"/>
Blue	<input checked="" type="checkbox"/>	Green	<input checked="" type="checkbox"/>
Orange	<input checked="" type="checkbox"/>	Orange/Black	<input checked="" type="checkbox"/>
Purple	<input checked="" type="checkbox"/>	Purple/Black	<input checked="" type="checkbox"/>
Yellow	<input checked="" type="checkbox"/>	Yellow/Black	<input checked="" type="checkbox"/>

Data-Link (2 way)

	<input checked="" type="checkbox"/>
Brown/White	<input checked="" type="checkbox"/>
Grey	<input checked="" type="checkbox"/>
Grey/Black	<input checked="" type="checkbox"/>
Brown	<input checked="" type="checkbox"/>



Technical support:
TEL: 514-255-HELP (4357)
FAX: 514-255-1367
Web: www.ifar.ca

Neither the manufacturer or distributor of this module is responsible of damages of any kind indirectly or directly caused by this module, except for the replacement of this module in case of manufacturing defects. This module must be install by qualified technician. This instruction guide may change without notice. Visit www.ifar.ca to get latest version.



SATURN Astra

2008-2009



CAN-SL2

Made in Canada Rev. A - 14 / 01 / 2009
Web site: <http://www.ifar.ca>

ALARM AND REMOTE STARTER CAN BUS INTERFACE KIT

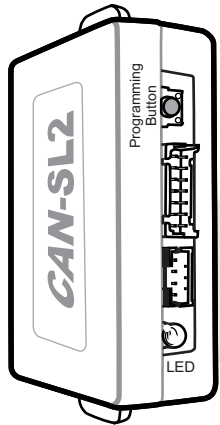

Front view of the module

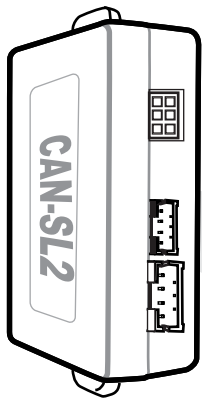
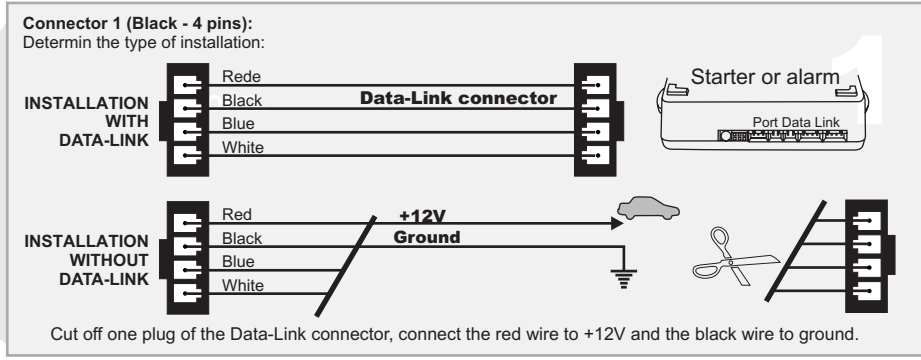

Back of the module

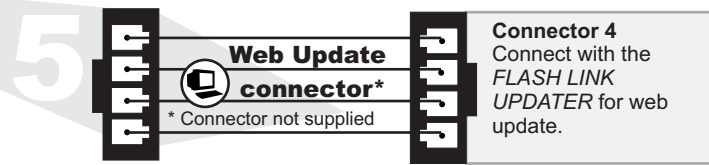

Connect wire to Remote-Starter/Alarm Connect wire to vehicle

○ OUTPUT ● INPUT

1

1.A **Make the connections of the CAN-SL2 to the vehicle:**

Connector 1 (Black):
Determine the type of installation:
INSTALLATION WITH DATA-LINK
INSTALLATION WITHOUT DATA-LINK

1.B

Connector 2 (White):
Make the connections

1.C

Connector 3 (White, located at the back of the module):
Make the connections

2

Press the programming switch while inserting the main wires harness (**CONN 1**) into the CAN-SL2 module. The LED will illuminate to indicate you are in programming mode, release the programming button.

3

Connect the other connectors (**CONN. 2**)

WARNING: Connector 2 can be easily plugged in backwards.

4

Connect the other connectors (**CONN. 3**)

5

Turn the key to the **"ON"** position.

6

Once the LED starts to flash rapidly turn the key to the **OFF** position.

The LED will turn off to indicate the module has been programmed.

The module is now ready for use.



Technical support:
TEL: 514-255-HELP (4357)
FAX: 514-255-1367
Web: www.ifar.ca

Neither the manufacturer or distributor of this module is responsible of damages of any kind indirectly or directly caused by this module, except for the replacement of this module in case of manufacturing defects. This module must be install by qualified technician. This instruction guide may change without notice. Visit www.ifar.ca to get latest version.



SATURN Astra

2008-2009



CAN-SL2

Fabriqué au Canada Rev. A - 14 / 01 / 2009
Site internet <http://www.ifar.ca>

MODULE D'INTERFACE CAN BUS POUR ALARME ET DÉMARREUR À DISTANCE

Fonctionnel if equipped

- | | | | |
|--|--|--|--|
| <input checked="" type="checkbox"/> Verrouillage | <input checked="" type="checkbox"/> Tach | <input type="checkbox"/> Radio Off | <input type="checkbox"/> Sièges chauffants |
| <input checked="" type="checkbox"/> Déverrouillage | <input checked="" type="checkbox"/> Active Démarreur | <input type="checkbox"/> Transponder Bypass | <input type="checkbox"/> Porte essence |
| <input checked="" type="checkbox"/> Armement | <input checked="" type="checkbox"/> Status de Porte | <input type="checkbox"/> PK3, Passlock | <input checked="" type="checkbox"/> Contrôle fenêtre |
| <input checked="" type="checkbox"/> Désarmement | <input checked="" type="checkbox"/> Status de Valise | <input type="checkbox"/> Portes Coulissantes | <input type="checkbox"/> Hayon arrière |
| <input type="checkbox"/> Valise | <input type="checkbox"/> Status de Capot | <input type="checkbox"/> Dégivrage | <input type="checkbox"/> Signal de Frein |

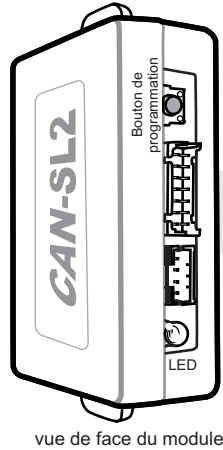

vue de face du module

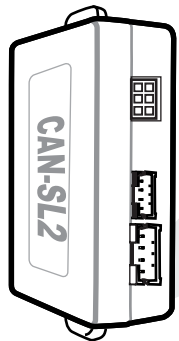

Vue de dos du module

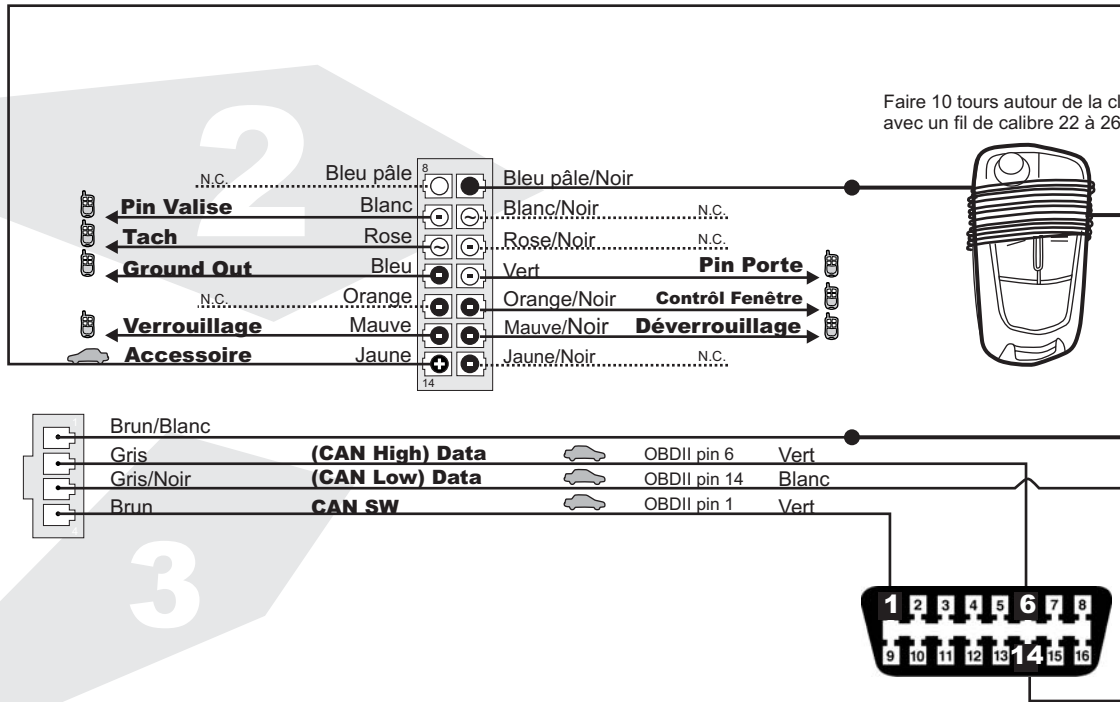

DÉMARREUR À DISTANCE

La sortie Start du démarreur à distance n'est pas requise pour ce véhicule.

Ingition
Accessoire

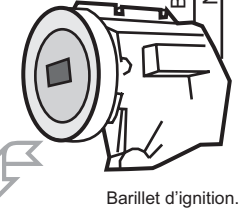

Barillet d'ignition.

- 1 Retirez le couvert de plastique du barillet d'ignition.
- 2 Faire a 4 tours à l'intérieur de l'anneau de plastique avec le fil.

Branchement du filage au démarreur à distance/Alarme Branchement du filage au véhicule ○ SORTIE ● ENTRÉE



Support Technique:
TEL: 514-255-HELP (4357)
FAX: 514-255-1367
Site internet: www.ifar.ca

Ni le manufacturier, ni le distributeur ne se considèrent responsables des dommages causés ou ayant pu être causés, indirectement ou directement, par ce module, excepté le remplacement de ce module en cas de défectuosité de fabrication. Ce module doit être installé par un technicien qualifié. Ce guide d'instruction peut faire l'objet de changement sans préavis. Consultez le www.ifar.ca pour voir la plus récente version.

<p>Branchez: ✓</p> <table border="0"> <tr><td>Bleu pâle</td><td><input checked="" type="checkbox"/></td><td>Bleu pâle/Noir</td></tr> <tr><td>Blanc</td><td><input checked="" type="checkbox"/></td><td>Blanc/Noir</td></tr> <tr><td>Rose</td><td><input checked="" type="checkbox"/></td><td>Rose/Noir</td></tr> <tr><td>Bleu</td><td><input checked="" type="checkbox"/></td><td>Vert</td></tr> <tr><td>Orange</td><td><input type="checkbox"/></td><td>Orange/Noir</td></tr> <tr><td>Mauve</td><td><input type="checkbox"/></td><td>Mauve/Noir</td></tr> <tr><td>Jaune</td><td><input checked="" type="checkbox"/></td><td>Jaune/Noir</td></tr> </table>	Bleu pâle	<input checked="" type="checkbox"/>	Bleu pâle/Noir	Blanc	<input checked="" type="checkbox"/>	Blanc/Noir	Rose	<input checked="" type="checkbox"/>	Rose/Noir	Bleu	<input checked="" type="checkbox"/>	Vert	Orange	<input type="checkbox"/>	Orange/Noir	Mauve	<input type="checkbox"/>	Mauve/Noir	Jaune	<input checked="" type="checkbox"/>	Jaune/Noir	<p>Data-Link (1 way)</p> <p> <input type="checkbox"/> Brun/Blanc <input type="checkbox"/> Gris <input type="checkbox"/> Gris/Noir <input type="checkbox"/> Brun </p>	<p>Branchez: ✓</p> <table border="0"> <tr><td>Bleu pâle</td><td><input checked="" type="checkbox"/></td><td>Bleu pâle/Noir</td></tr> <tr><td>Blanc</td><td><input checked="" type="checkbox"/></td><td>Blanc/Noir</td></tr> <tr><td>Rose</td><td><input checked="" type="checkbox"/></td><td>Rose/Noir</td></tr> <tr><td>Bleu</td><td><input checked="" type="checkbox"/></td><td>Vert</td></tr> <tr><td>Orange</td><td><input type="checkbox"/></td><td>Orange/Noir</td></tr> <tr><td>Mauve</td><td><input type="checkbox"/></td><td>Mauve/Noir</td></tr> <tr><td>Jaune</td><td><input checked="" type="checkbox"/></td><td>Jaune/Noir</td></tr> </table>	Bleu pâle	<input checked="" type="checkbox"/>	Bleu pâle/Noir	Blanc	<input checked="" type="checkbox"/>	Blanc/Noir	Rose	<input checked="" type="checkbox"/>	Rose/Noir	Bleu	<input checked="" type="checkbox"/>	Vert	Orange	<input type="checkbox"/>	Orange/Noir	Mauve	<input type="checkbox"/>	Mauve/Noir	Jaune	<input checked="" type="checkbox"/>	Jaune/Noir	<p>Data-Link (2 way)</p> <p> <input type="checkbox"/> Brun/Blanc <input type="checkbox"/> Gris <input type="checkbox"/> Gris/Noir <input type="checkbox"/> Brun </p>
Bleu pâle	<input checked="" type="checkbox"/>	Bleu pâle/Noir																																											
Blanc	<input checked="" type="checkbox"/>	Blanc/Noir																																											
Rose	<input checked="" type="checkbox"/>	Rose/Noir																																											
Bleu	<input checked="" type="checkbox"/>	Vert																																											
Orange	<input type="checkbox"/>	Orange/Noir																																											
Mauve	<input type="checkbox"/>	Mauve/Noir																																											
Jaune	<input checked="" type="checkbox"/>	Jaune/Noir																																											
Bleu pâle	<input checked="" type="checkbox"/>	Bleu pâle/Noir																																											
Blanc	<input checked="" type="checkbox"/>	Blanc/Noir																																											
Rose	<input checked="" type="checkbox"/>	Rose/Noir																																											
Bleu	<input checked="" type="checkbox"/>	Vert																																											
Orange	<input type="checkbox"/>	Orange/Noir																																											
Mauve	<input type="checkbox"/>	Mauve/Noir																																											
Jaune	<input checked="" type="checkbox"/>	Jaune/Noir																																											



SATURN Astra

2008-2009



CAN-SL2

Fabriqué au Canada Rev. A - 14 / 01 / 2009
Site internet <http://www.ifar.ca>

MODULE D'INTERFACE CAN BUS POUR ALARME ET DÉMARREUR À DISTANCE

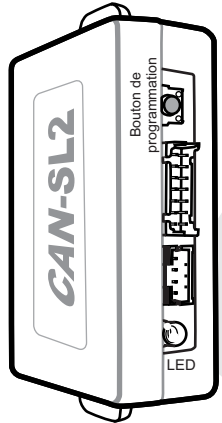

vue de face du module

Connecteur 1 (Noir - 4 pins):
Déterminez le type d'installation:

INSTALLATION AVEC DATA-LINK

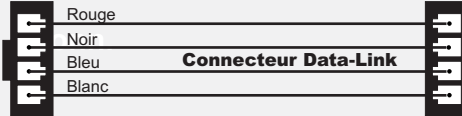

Démarrateur à distance et Alarme

INSTALLATION SANS DATA-LINK

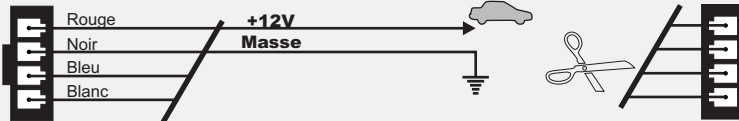

Coupez les 4 fils à l'extrémité de l'un des deux connecteurs Data-Link. Connectez le fil rouge au 12V et le fil noir à la masse du véhicule.

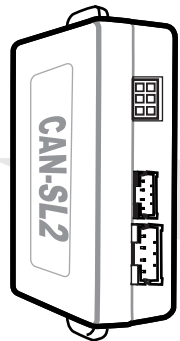

Vue de dos du module

5

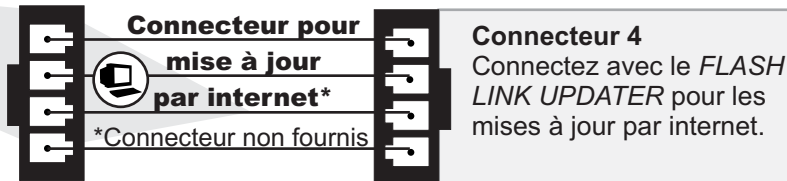

Branchement du filage au démarreur à distance/Alarme Branchement du filage au véhicule ○ SORTIE ● ENTRÉE

1

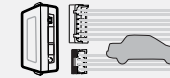

Effectuez les connexions du CAN-SL2 au véhicule:



1.A

Connecteur 1 (Noir):

Déterminez le type d'installation (**Data-Link** ou **non Data-Link**)
Pour l'installation DATA-LINK assurez vous de la présence du connecteur DATA-LINK sur le démarreur..
Pour installation non Data-Link voir INSTALLATION SANS DATA-LINK.



1.B

Connecteur 2 (Blanc):

Effectuez les branchements



1.C

Connecteur 3 (Blanc, situé au dos du module):

Effectuez les branchements

2



Maintenez le bouton de programmation enfoncé en insérant le **connecteur 1** dans le CAN-SL2.
Le DEL s'allume pour indiquer le début de la programmation, **relâchez le bouton de programmation.**

3

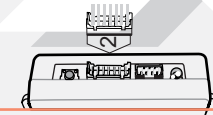

Branchez le connecteur 2 (**CONN. 2**)

ATTENTION: Ne pas brancher le connecteur à l'envers.

4



Branchez le connecteur 3 (**CONN. 3**)

5



Tournez la clef en position **ignition**.

6

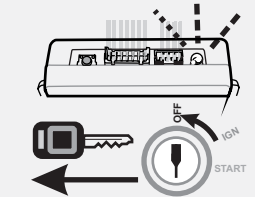

Lorsque le DEL clignote rapidement, **tournez la clef en position OFF.**

Le DEL s'éteint pour indiquer que le module est programmé.



Support Technique:
TEL: 514-255-HELP (4357)
FAX: 514-255-1367
Site internet: www.ifar.ca

Ni le manufacturier, ni le distributeur ne se considèrent responsables des dommages causés ou ayant pu être causés, indirectement ou directement, par ce module, excepté le remplacement de ce module en cas de défectuosité de fabrication. Ce module doit être installé par un technicien qualifié. Ce guide d'instruction peut faire l'objet de changement sans préavis. Consultez le www.ifar.ca pour voir la plus récente version.