

Fonctionnal if equipped

- |                                 |  |   |   |
|---------------------------------|--|---|---|
| <input type="checkbox"/> Lock   | <input type="checkbox"/> Tach          | <input type="checkbox"/> Radio Off          | <input type="checkbox"/> Heat Seats       |
| <input type="checkbox"/> Unlock | <input type="checkbox"/> Start Enable  | <input type="checkbox"/> Transponder Bypass | <input type="checkbox"/> Gas Door         |
| <input type="checkbox"/> Arm    | <input type="checkbox"/> Door Trigger  | <input type="checkbox"/> PK3, Passlock      | <input type="checkbox"/> Window Roll Down |
| <input type="checkbox"/> Disarm | <input type="checkbox"/> Trunk Trigger | <input type="checkbox"/> Sliding Door       | <input type="checkbox"/> Hatch            |
| <input type="checkbox"/> Trunk  | <input type="checkbox"/> Hood Trigger  | <input type="checkbox"/> Defrost            | <input type="checkbox"/> Brake Signal     |

**WARNING:** All Ignition and accessory wires of the remote starter must be connected at the ignition barrel.

**WARNING:** Every time the CAN-SL2 is disconnected, once reconnected the vehicle need to be started with the key.

Connection for Transponder bypass.

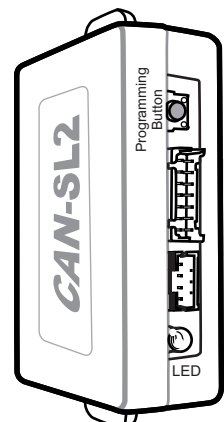

Front view of the module

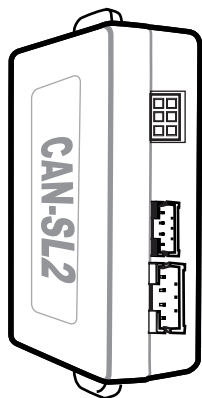

Back of the module

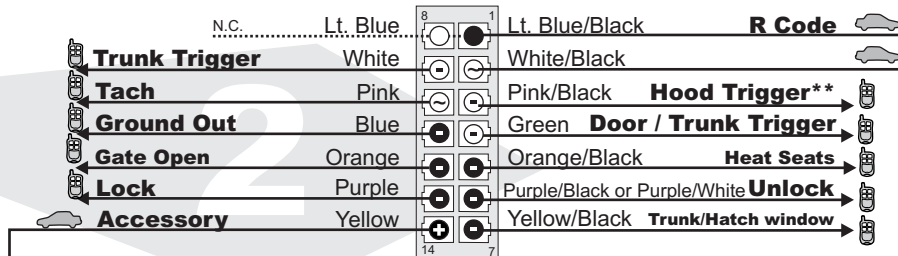

\*\* Only if the vehicle is equipped with a hood pin.

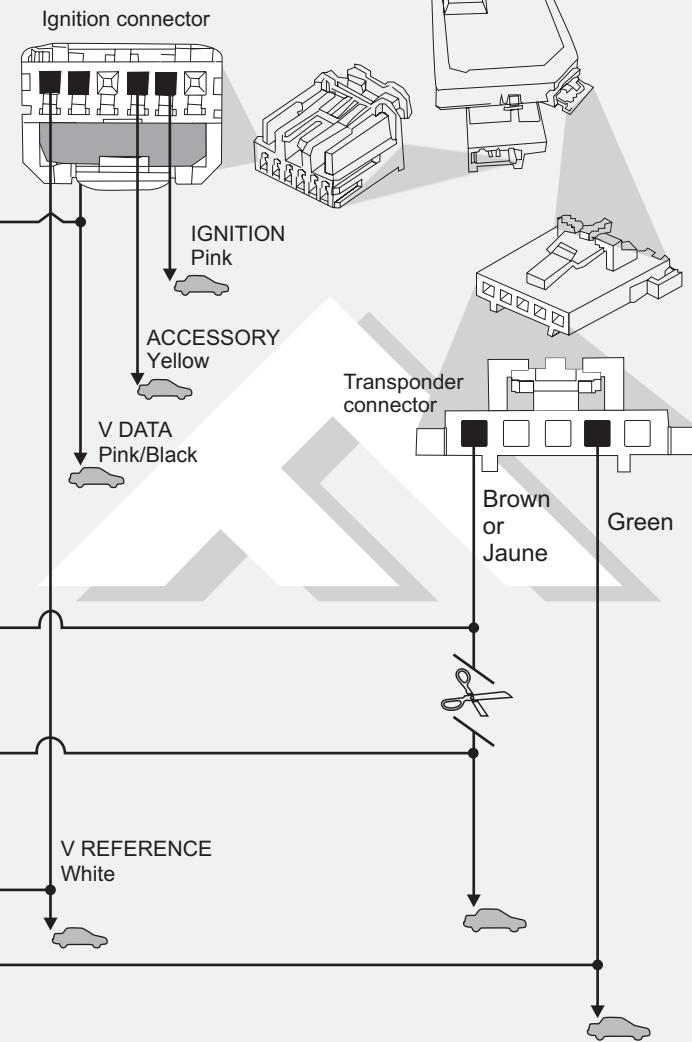

Connect wire to Remote-Starter/Alarm Connect wire to vehicle

○ OUTPUT ● INPUT

|   |                                     |                                     |                                     |                                     |       |                                     |             |                                     |      |                                     |            |                                     |      |                                     |       |                          |        |                          |              |                          |        |                          |              |                          |        |                          |              |                          |   |             |                                     |      |                          |            |                                     |       |                                     |  |          |                                     |                |                                     |       |                                     |             |                                     |      |                          |            |                          |      |                          |       |                          |        |                          |              |                          |        |                          |              |                          |        |                          |              |                          |   |             |                                     |      |                          |            |                                     |       |                                     |
|---|-------------------------------------|-------------------------------------|-------------------------------------|-------------------------------------|-------|-------------------------------------|-------------|-------------------------------------|------|-------------------------------------|------------|-------------------------------------|------|-------------------------------------|-------|--------------------------|--------|--------------------------|--------------|--------------------------|--------|--------------------------|--------------|--------------------------|--------|--------------------------|--------------|--------------------------|---|-------------|-------------------------------------|------|--------------------------|------------|-------------------------------------|-------|-------------------------------------|--|----------|-------------------------------------|----------------|-------------------------------------|-------|-------------------------------------|-------------|-------------------------------------|------|--------------------------|------------|--------------------------|------|--------------------------|-------|--------------------------|--------|--------------------------|--------------|--------------------------|--------|--------------------------|--------------|--------------------------|--------|--------------------------|--------------|--------------------------|---|-------------|-------------------------------------|------|--------------------------|------------|-------------------------------------|-------|-------------------------------------|
| <p>Connect: ✓ Branchez: ✓</p> <table border="0"> <tr><td>Lt. Blue</td><td><input checked="" type="checkbox"/></td><td>Lt. Blue/Black</td><td><input checked="" type="checkbox"/></td></tr> <tr><td>White</td><td><input checked="" type="checkbox"/></td><td>White/Black</td><td><input checked="" type="checkbox"/></td></tr> <tr><td>Pink</td><td><input checked="" type="checkbox"/></td><td>Pink/Black</td><td><input checked="" type="checkbox"/></td></tr> <tr><td>Blue</td><td><input checked="" type="checkbox"/></td><td>Green</td><td><input type="checkbox"/></td></tr> <tr><td>Orange</td><td><input type="checkbox"/></td><td>Orange/Black</td><td><input type="checkbox"/></td></tr> <tr><td>Purple</td><td><input type="checkbox"/></td><td>Purple/Black</td><td><input type="checkbox"/></td></tr> <tr><td>Yellow</td><td><input type="checkbox"/></td><td>Yellow/Black</td><td><input type="checkbox"/></td></tr> </table> | Lt. Blue                            | <input checked="" type="checkbox"/> | Lt. Blue/Black                      | <input checked="" type="checkbox"/> | White | <input checked="" type="checkbox"/> | White/Black | <input checked="" type="checkbox"/> | Pink | <input checked="" type="checkbox"/> | Pink/Black | <input checked="" type="checkbox"/> | Blue | <input checked="" type="checkbox"/> | Green | <input type="checkbox"/> | Orange | <input type="checkbox"/> | Orange/Black | <input type="checkbox"/> | Purple | <input type="checkbox"/> | Purple/Black | <input type="checkbox"/> | Yellow | <input type="checkbox"/> | Yellow/Black | <input type="checkbox"/> | <p><b>Data-Link (1 way)</b></p> <p><b>DL</b> →</p> <table border="0"> <tr><td>Brown/White</td><td><input checked="" type="checkbox"/></td></tr> <tr><td>Grey</td><td><input type="checkbox"/></td></tr> <tr><td>Grey/Black</td><td><input checked="" type="checkbox"/></td></tr> <tr><td>Brown</td><td><input checked="" type="checkbox"/></td></tr> </table> | Brown/White | <input checked="" type="checkbox"/> | Grey | <input type="checkbox"/> | Grey/Black | <input checked="" type="checkbox"/> | Brown | <input checked="" type="checkbox"/> | <p>Connect: ✓ Branchez: ✓</p> <table border="0"> <tr><td>Lt. Blue</td><td><input checked="" type="checkbox"/></td><td>Lt. Blue/Black</td><td><input checked="" type="checkbox"/></td></tr> <tr><td>White</td><td><input checked="" type="checkbox"/></td><td>White/Black</td><td><input checked="" type="checkbox"/></td></tr> <tr><td>Pink</td><td><input type="checkbox"/></td><td>Pink/Black</td><td><input type="checkbox"/></td></tr> <tr><td>Blue</td><td><input type="checkbox"/></td><td>Green</td><td><input type="checkbox"/></td></tr> <tr><td>Orange</td><td><input type="checkbox"/></td><td>Orange/Black</td><td><input type="checkbox"/></td></tr> <tr><td>Purple</td><td><input type="checkbox"/></td><td>Purple/Black</td><td><input type="checkbox"/></td></tr> <tr><td>Yellow</td><td><input type="checkbox"/></td><td>Yellow/Black</td><td><input type="checkbox"/></td></tr> </table> | Lt. Blue | <input checked="" type="checkbox"/> | Lt. Blue/Black | <input checked="" type="checkbox"/> | White | <input checked="" type="checkbox"/> | White/Black | <input checked="" type="checkbox"/> | Pink | <input type="checkbox"/> | Pink/Black | <input type="checkbox"/> | Blue | <input type="checkbox"/> | Green | <input type="checkbox"/> | Orange | <input type="checkbox"/> | Orange/Black | <input type="checkbox"/> | Purple | <input type="checkbox"/> | Purple/Black | <input type="checkbox"/> | Yellow | <input type="checkbox"/> | Yellow/Black | <input type="checkbox"/> | <p><b>Data-Link (2 way)</b></p> <p>← <b>DL</b> →</p> <table border="0"> <tr><td>Brown/White</td><td><input checked="" type="checkbox"/></td></tr> <tr><td>Grey</td><td><input type="checkbox"/></td></tr> <tr><td>Grey/Black</td><td><input checked="" type="checkbox"/></td></tr> <tr><td>Brown</td><td><input checked="" type="checkbox"/></td></tr> </table> | Brown/White | <input checked="" type="checkbox"/> | Grey | <input type="checkbox"/> | Grey/Black | <input checked="" type="checkbox"/> | Brown | <input checked="" type="checkbox"/> |
| Lt. Blue  | <input checked="" type="checkbox"/> | Lt. Blue/Black                      | <input checked="" type="checkbox"/> |                                     |       |                                     |             |                                     |      |                                     |            |                                     |      |                                     |       |                          |        |                          |              |                          |        |                          |              |                          |        |                          |              |                          |   |             |                                     |      |                          |            |                                     |       |                                     |  |          |                                     |                |                                     |       |                                     |             |                                     |      |                          |            |                          |      |                          |       |                          |        |                          |              |                          |        |                          |              |                          |        |                          |              |                          |   |             |                                     |      |                          |            |                                     |       |                                     |
| White   | <input checked="" type="checkbox"/> | White/Black                         | <input checked="" type="checkbox"/> |                                     |       |                                     |             |                                     |      |                                     |            |                                     |      |                                     |       |                          |        |                          |              |                          |        |                          |              |                          |        |                          |              |                          |   |             |                                     |      |                          |            |                                     |       |                                     |  |          |                                     |                |                                     |       |                                     |             |                                     |      |                          |            |                          |      |                          |       |                          |        |                          |              |                          |        |                          |              |                          |        |                          |              |                          |   |             |                                     |      |                          |            |                                     |       |                                     |
| Pink  | <input checked="" type="checkbox"/> | Pink/Black                          | <input checked="" type="checkbox"/> |                                     |       |                                     |             |                                     |      |                                     |            |                                     |      |                                     |       |                          |        |                          |              |                          |        |                          |              |                          |        |                          |              |                          |   |             |                                     |      |                          |            |                                     |       |                                     |  |          |                                     |                |                                     |       |                                     |             |                                     |      |                          |            |                          |      |                          |       |                          |        |                          |              |                          |        |                          |              |                          |        |                          |              |                          |   |             |                                     |      |                          |            |                                     |       |                                     |
| Blue  | <input checked="" type="checkbox"/> | Green                               | <input type="checkbox"/>            |                                     |       |                                     |             |                                     |      |                                     |            |                                     |      |                                     |       |                          |        |                          |              |                          |        |                          |              |                          |        |                          |              |                          |   |             |                                     |      |                          |            |                                     |       |                                     |  |          |                                     |                |                                     |       |                                     |             |                                     |      |                          |            |                          |      |                          |       |                          |        |                          |              |                          |        |                          |              |                          |        |                          |              |                          |   |             |                                     |      |                          |            |                                     |       |                                     |
| Orange  | <input type="checkbox"/>            | Orange/Black                        | <input type="checkbox"/>            |                                     |       |                                     |             |                                     |      |                                     |            |                                     |      |                                     |       |                          |        |                          |              |                          |        |                          |              |                          |        |                          |              |                          |   |             |                                     |      |                          |            |                                     |       |                                     |  |          |                                     |                |                                     |       |                                     |             |                                     |      |                          |            |                          |      |                          |       |                          |        |                          |              |                          |        |                          |              |                          |        |                          |              |                          |   |             |                                     |      |                          |            |                                     |       |                                     |
| Purple  | <input type="checkbox"/>            | Purple/Black                        | <input type="checkbox"/>            |                                     |       |                                     |             |                                     |      |                                     |            |                                     |      |                                     |       |                          |        |                          |              |                          |        |                          |              |                          |        |                          |              |                          |   |             |                                     |      |                          |            |                                     |       |                                     |  |          |                                     |                |                                     |       |                                     |             |                                     |      |                          |            |                          |      |                          |       |                          |        |                          |              |                          |        |                          |              |                          |        |                          |              |                          |   |             |                                     |      |                          |            |                                     |       |                                     |
| Yellow  | <input type="checkbox"/>            | Yellow/Black                        | <input type="checkbox"/>            |                                     |       |                                     |             |                                     |      |                                     |            |                                     |      |                                     |       |                          |        |                          |              |                          |        |                          |              |                          |        |                          |              |                          |   |             |                                     |      |                          |            |                                     |       |                                     |  |          |                                     |                |                                     |       |                                     |             |                                     |      |                          |            |                          |      |                          |       |                          |        |                          |              |                          |        |                          |              |                          |        |                          |              |                          |   |             |                                     |      |                          |            |                                     |       |                                     |
| Brown/White   | <input checked="" type="checkbox"/> |                                     |                                     |                                     |       |                                     |             |                                     |      |                                     |            |                                     |      |                                     |       |                          |        |                          |              |                          |        |                          |              |                          |        |                          |              |                          |   |             |                                     |      |                          |            |                                     |       |                                     |  |          |                                     |                |                                     |       |                                     |             |                                     |      |                          |            |                          |      |                          |       |                          |        |                          |              |                          |        |                          |              |                          |        |                          |              |                          |   |             |                                     |      |                          |            |                                     |       |                                     |
| Grey  | <input type="checkbox"/>            |                                     |                                     |                                     |       |                                     |             |                                     |      |                                     |            |                                     |      |                                     |       |                          |        |                          |              |                          |        |                          |              |                          |        |                          |              |                          |   |             |                                     |      |                          |            |                                     |       |                                     |  |          |                                     |                |                                     |       |                                     |             |                                     |      |                          |            |                          |      |                          |       |                          |        |                          |              |                          |        |                          |              |                          |        |                          |              |                          |   |             |                                     |      |                          |            |                                     |       |                                     |
| Grey/Black  | <input checked="" type="checkbox"/> |                                     |                                     |                                     |       |                                     |             |                                     |      |                                     |            |                                     |      |                                     |       |                          |        |                          |              |                          |        |                          |              |                          |        |                          |              |                          |   |             |                                     |      |                          |            |                                     |       |                                     |  |          |                                     |                |                                     |       |                                     |             |                                     |      |                          |            |                          |      |                          |       |                          |        |                          |              |                          |        |                          |              |                          |        |                          |              |                          |   |             |                                     |      |                          |            |                                     |       |                                     |
| Brown   | <input checked="" type="checkbox"/> |                                     |                                     |                                     |       |                                     |             |                                     |      |                                     |            |                                     |      |                                     |       |                          |        |                          |              |                          |        |                          |              |                          |        |                          |              |                          |   |             |                                     |      |                          |            |                                     |       |                                     |  |          |                                     |                |                                     |       |                                     |             |                                     |      |                          |            |                          |      |                          |       |                          |        |                          |              |                          |        |                          |              |                          |        |                          |              |                          |   |             |                                     |      |                          |            |                                     |       |                                     |
| Lt. Blue  | <input checked="" type="checkbox"/> | Lt. Blue/Black                      | <input checked="" type="checkbox"/> |                                     |       |                                     |             |                                     |      |                                     |            |                                     |      |                                     |       |                          |        |                          |              |                          |        |                          |              |                          |        |                          |              |                          |   |             |                                     |      |                          |            |                                     |       |                                     |  |          |                                     |                |                                     |       |                                     |             |                                     |      |                          |            |                          |      |                          |       |                          |        |                          |              |                          |        |                          |              |                          |        |                          |              |                          |   |             |                                     |      |                          |            |                                     |       |                                     |
| White   | <input checked="" type="checkbox"/> | White/Black                         | <input checked="" type="checkbox"/> |                                     |       |                                     |             |                                     |      |                                     |            |                                     |      |                                     |       |                          |        |                          |              |                          |        |                          |              |                          |        |                          |              |                          |   |             |                                     |      |                          |            |                                     |       |                                     |  |          |                                     |                |                                     |       |                                     |             |                                     |      |                          |            |                          |      |                          |       |                          |        |                          |              |                          |        |                          |              |                          |        |                          |              |                          |   |             |                                     |      |                          |            |                                     |       |                                     |
| Pink  | <input type="checkbox"/>            | Pink/Black                          | <input type="checkbox"/>            |                                     |       |                                     |             |                                     |      |                                     |            |                                     |      |                                     |       |                          |        |                          |              |                          |        |                          |              |                          |        |                          |              |                          |   |             |                                     |      |                          |            |                                     |       |                                     |  |          |                                     |                |                                     |       |                                     |             |                                     |      |                          |            |                          |      |                          |       |                          |        |                          |              |                          |        |                          |              |                          |        |                          |              |                          |   |             |                                     |      |                          |            |                                     |       |                                     |
| Blue  | <input type="checkbox"/>            | Green                               | <input type="checkbox"/>            |                                     |       |                                     |             |                                     |      |                                     |            |                                     |      |                                     |       |                          |        |                          |              |                          |        |                          |              |                          |        |                          |              |                          |   |             |                                     |      |                          |            |                                     |       |                                     |  |          |                                     |                |                                     |       |                                     |             |                                     |      |                          |            |                          |      |                          |       |                          |        |                          |              |                          |        |                          |              |                          |        |                          |              |                          |   |             |                                     |      |                          |            |                                     |       |                                     |
| Orange  | <input type="checkbox"/>            | Orange/Black                        | <input type="checkbox"/>            |                                     |       |                                     |             |                                     |      |                                     |            |                                     |      |                                     |       |                          |        |                          |              |                          |        |                          |              |                          |        |                          |              |                          |   |             |                                     |      |                          |            |                                     |       |                                     |  |          |                                     |                |                                     |       |                                     |             |                                     |      |                          |            |                          |      |                          |       |                          |        |                          |              |                          |        |                          |              |                          |        |                          |              |                          |   |             |                                     |      |                          |            |                                     |       |                                     |
| Purple  | <input type="checkbox"/>            | Purple/Black                        | <input type="checkbox"/>            |                                     |       |                                     |             |                                     |      |                                     |            |                                     |      |                                     |       |                          |        |                          |              |                          |        |                          |              |                          |        |                          |              |                          |   |             |                                     |      |                          |            |                                     |       |                                     |  |          |                                     |                |                                     |       |                                     |             |                                     |      |                          |            |                          |      |                          |       |                          |        |                          |              |                          |        |                          |              |                          |        |                          |              |                          |   |             |                                     |      |                          |            |                                     |       |                                     |
| Yellow  | <input type="checkbox"/>            | Yellow/Black                        | <input type="checkbox"/>            |                                     |       |                                     |             |                                     |      |                                     |            |                                     |      |                                     |       |                          |        |                          |              |                          |        |                          |              |                          |        |                          |              |                          |   |             |                                     |      |                          |            |                                     |       |                                     |  |          |                                     |                |                                     |       |                                     |             |                                     |      |                          |            |                          |      |                          |       |                          |        |                          |              |                          |        |                          |              |                          |        |                          |              |                          |   |             |                                     |      |                          |            |                                     |       |                                     |
| Brown/White   | <input checked="" type="checkbox"/> |                                     |                                     |                                     |       |                                     |             |                                     |      |                                     |            |                                     |      |                                     |       |                          |        |                          |              |                          |        |                          |              |                          |        |                          |              |                          |   |             |                                     |      |                          |            |                                     |       |                                     |  |          |                                     |                |                                     |       |                                     |             |                                     |      |                          |            |                          |      |                          |       |                          |        |                          |              |                          |        |                          |              |                          |        |                          |              |                          |   |             |                                     |      |                          |            |                                     |       |                                     |
| Grey  | <input type="checkbox"/>            |                                     |                                     |                                     |       |                                     |             |                                     |      |                                     |            |                                     |      |                                     |       |                          |        |                          |              |                          |        |                          |              |                          |        |                          |              |                          |   |             |                                     |      |                          |            |                                     |       |                                     |  |          |                                     |                |                                     |       |                                     |             |                                     |      |                          |            |                          |      |                          |       |                          |        |                          |              |                          |        |                          |              |                          |        |                          |              |                          |   |             |                                     |      |                          |            |                                     |       |                                     |
| Grey/Black  | <input checked="" type="checkbox"/> |                                     |                                     |                                     |       |                                     |             |                                     |      |                                     |            |                                     |      |                                     |       |                          |        |                          |              |                          |        |                          |              |                          |        |                          |              |                          |   |             |                                     |      |                          |            |                                     |       |                                     |  |          |                                     |                |                                     |       |                                     |             |                                     |      |                          |            |                          |      |                          |       |                          |        |                          |              |                          |        |                          |              |                          |        |                          |              |                          |   |             |                                     |      |                          |            |                                     |       |                                     |
| Brown   | <input checked="" type="checkbox"/> |                                     |                                     |                                     |       |                                     |             |                                     |      |                                     |            |                                     |      |                                     |       |                          |        |                          |              |                          |        |                          |              |                          |        |                          |              |                          |   |             |                                     |      |                          |            |                                     |       |                                     |  |          |                                     |                |                                     |       |                                     |             |                                     |      |                          |            |                          |      |                          |       |                          |        |                          |              |                          |        |                          |              |                          |        |                          |              |                          |   |             |                                     |      |                          |            |                                     |       |                                     |

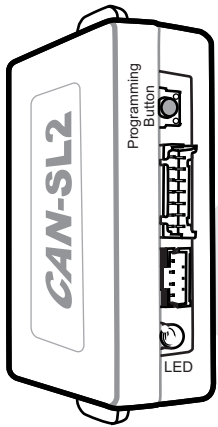

Front view of the module

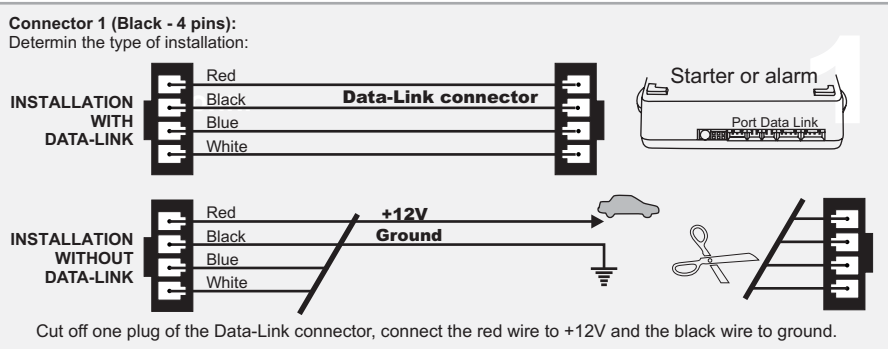

**1** **1.A** **Make the connections of the CAN-SL2 to the vehicle:**

**Connector 1 (Black):**  
Determine the type of installation:  
INSTALLATION WITH DATA-LINK  
INSTALLATION WITHOUT DATA-LINK

**1.B** **Connector 2 (White):**  
Make the connections

**1.C** **Connector 3 (White, located at the back of the module):**  
Make the connections

**2** **Press the programming switch while inserting the main wires harness (CONN 1) into the CAN-SL2 module.**  
The LED will illuminate to indicate you are in programming mode, release the programming button.

**3** **Connect the other connectors (CONN. 2)**  
**WARNING: Connector 2 can be easily plugged in backwards.**

**4** **Connect the other connectors (CONN. 3)**

**5** Turn the key to the **"ON" position.**

**6** Once the LED starts to flash rapidly turn the key to the **OFF position.**  
The LED will turn off to indicate the module has been programmed.  
**The module is now ready for use.**

Connect wire to Remote-Starter/Alarm Connect wire to vehicle

○ OUTPUT ● INPUT

Fonctionnel si équipé

- |   |   |   |  |
|---|---|---|--|
| <input type="checkbox"/> Verrouillage   | <input type="checkbox"/> Tach             | <input type="checkbox"/> Radio Off          | <input type="checkbox"/> Sièges chauffants |
| <input type="checkbox"/> Déverrouillage | <input type="checkbox"/> Active Démarreur | <input type="checkbox"/> Transponder Bypass | <input type="checkbox"/> Porte essence     |
| <input type="checkbox"/> Armement       | <input type="checkbox"/> Status de Porte  | <input type="checkbox"/> PK3, Passlock      | <input type="checkbox"/> Contrôle fenêtres |
| <input type="checkbox"/> Désarmement    | <input type="checkbox"/> Status de Valise | <input type="checkbox"/> Portes Couissantes | <input type="checkbox"/> Hayon arrière     |
| <input type="checkbox"/> Valise         | <input type="checkbox"/> Status de Capot  | <input type="checkbox"/> Dégivrage          | <input type="checkbox"/> Signal de Frein   |

**ATTENTION:** Les fils d'ignition et d'accessoire du démarreur à distance doivent être connectés au barillet d'ignition.

**ATTENTION:** Chaque fois que le CAN-SL2 est débranché, une fois le module rebranché, démarrez le véhicule avec la clé.

Connexions pour le contournement transpondeur.

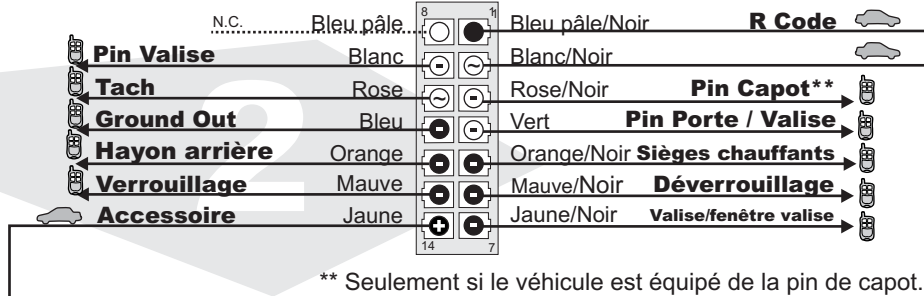
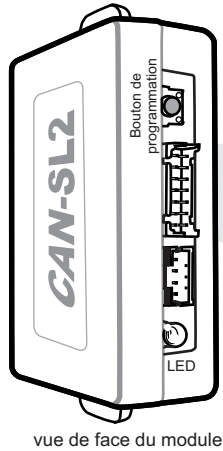

vue de face du module

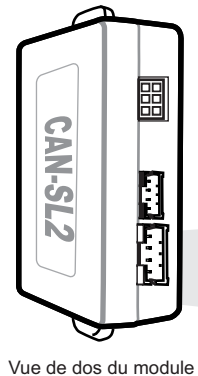

Vue de dos du module

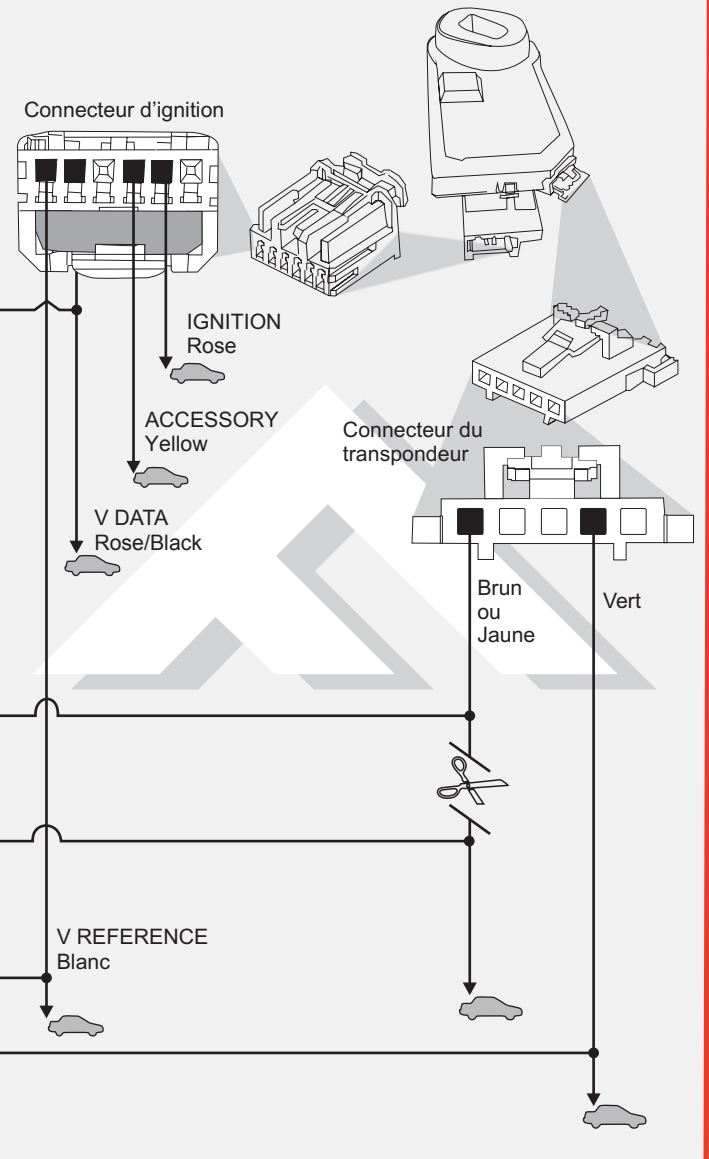

Branchement du filage au démarreur à distance/Alarme Branchement du filage au véhicule ○ SORTIE ● ENTRÉE

|  |                                     |                                     |                                     |                |                                     |       |                                     |            |                                     |      |                                     |           |                                     |      |                                     |      |                                     |        |                                     |             |                                     |       |                                     |            |                                     |       |                                     |            |   |                                     |            |                                     |      |                                     |           |                                     |      |  |                                     |           |                                     |                |                                     |       |                                     |            |                                     |      |                                     |           |                                     |      |                                     |      |                                     |        |                                     |             |                                     |       |                                     |            |                                     |       |                                     |            |   |                                     |            |                                     |      |                                     |           |                                     |      |
|--|-------------------------------------|-------------------------------------|-------------------------------------|----------------|-------------------------------------|-------|-------------------------------------|------------|-------------------------------------|------|-------------------------------------|-----------|-------------------------------------|------|-------------------------------------|------|-------------------------------------|--------|-------------------------------------|-------------|-------------------------------------|-------|-------------------------------------|------------|-------------------------------------|-------|-------------------------------------|------------|---|-------------------------------------|------------|-------------------------------------|------|-------------------------------------|-----------|-------------------------------------|------|--|-------------------------------------|-----------|-------------------------------------|----------------|-------------------------------------|-------|-------------------------------------|------------|-------------------------------------|------|-------------------------------------|-----------|-------------------------------------|------|-------------------------------------|------|-------------------------------------|--------|-------------------------------------|-------------|-------------------------------------|-------|-------------------------------------|------------|-------------------------------------|-------|-------------------------------------|------------|---|-------------------------------------|------------|-------------------------------------|------|-------------------------------------|-----------|-------------------------------------|------|
| <p>Branchez: ✓</p> <table border="0"> <tr><td><input checked="" type="checkbox"/></td><td>Bleu pâle</td><td><input checked="" type="checkbox"/></td><td>Bleu pâle/Noir</td></tr> <tr><td><input checked="" type="checkbox"/></td><td>Blanc</td><td><input checked="" type="checkbox"/></td><td>Blanc/Noir</td></tr> <tr><td><input checked="" type="checkbox"/></td><td>Rose</td><td><input checked="" type="checkbox"/></td><td>Rose/Noir</td></tr> <tr><td><input checked="" type="checkbox"/></td><td>Bleu</td><td><input checked="" type="checkbox"/></td><td>Vert</td></tr> <tr><td><input checked="" type="checkbox"/></td><td>Orange</td><td><input checked="" type="checkbox"/></td><td>Orange/Noir</td></tr> <tr><td><input checked="" type="checkbox"/></td><td>Mauve</td><td><input checked="" type="checkbox"/></td><td>Mauve/Noir</td></tr> <tr><td><input checked="" type="checkbox"/></td><td>Jaune</td><td><input checked="" type="checkbox"/></td><td>Jaune/Noir</td></tr> </table> | <input checked="" type="checkbox"/> | Bleu pâle                           | <input checked="" type="checkbox"/> | Bleu pâle/Noir | <input checked="" type="checkbox"/> | Blanc | <input checked="" type="checkbox"/> | Blanc/Noir | <input checked="" type="checkbox"/> | Rose | <input checked="" type="checkbox"/> | Rose/Noir | <input checked="" type="checkbox"/> | Bleu | <input checked="" type="checkbox"/> | Vert | <input checked="" type="checkbox"/> | Orange | <input checked="" type="checkbox"/> | Orange/Noir | <input checked="" type="checkbox"/> | Mauve | <input checked="" type="checkbox"/> | Mauve/Noir | <input checked="" type="checkbox"/> | Jaune | <input checked="" type="checkbox"/> | Jaune/Noir | <p><b>Data-Link (1 way)</b></p> <p><b>DL</b> →</p> <table border="0"> <tr><td><input checked="" type="checkbox"/></td><td>Brun/Blanc</td></tr> <tr><td><input checked="" type="checkbox"/></td><td>Gris</td></tr> <tr><td><input checked="" type="checkbox"/></td><td>Gris/Noir</td></tr> <tr><td><input checked="" type="checkbox"/></td><td>Brun</td></tr> </table> | <input checked="" type="checkbox"/> | Brun/Blanc | <input checked="" type="checkbox"/> | Gris | <input checked="" type="checkbox"/> | Gris/Noir | <input checked="" type="checkbox"/> | Brun | <p>Branchez: ✓</p> <table border="0"> <tr><td><input checked="" type="checkbox"/></td><td>Bleu pâle</td><td><input checked="" type="checkbox"/></td><td>Bleu pâle/Noir</td></tr> <tr><td><input checked="" type="checkbox"/></td><td>Blanc</td><td><input checked="" type="checkbox"/></td><td>Blanc/Noir</td></tr> <tr><td><input checked="" type="checkbox"/></td><td>Rose</td><td><input checked="" type="checkbox"/></td><td>Rose/Noir</td></tr> <tr><td><input checked="" type="checkbox"/></td><td>Bleu</td><td><input checked="" type="checkbox"/></td><td>Vert</td></tr> <tr><td><input checked="" type="checkbox"/></td><td>Orange</td><td><input checked="" type="checkbox"/></td><td>Orange/Noir</td></tr> <tr><td><input checked="" type="checkbox"/></td><td>Mauve</td><td><input checked="" type="checkbox"/></td><td>Mauve/Noir</td></tr> <tr><td><input checked="" type="checkbox"/></td><td>Jaune</td><td><input checked="" type="checkbox"/></td><td>Jaune/Noir</td></tr> </table> | <input checked="" type="checkbox"/> | Bleu pâle | <input checked="" type="checkbox"/> | Bleu pâle/Noir | <input checked="" type="checkbox"/> | Blanc | <input checked="" type="checkbox"/> | Blanc/Noir | <input checked="" type="checkbox"/> | Rose | <input checked="" type="checkbox"/> | Rose/Noir | <input checked="" type="checkbox"/> | Bleu | <input checked="" type="checkbox"/> | Vert | <input checked="" type="checkbox"/> | Orange | <input checked="" type="checkbox"/> | Orange/Noir | <input checked="" type="checkbox"/> | Mauve | <input checked="" type="checkbox"/> | Mauve/Noir | <input checked="" type="checkbox"/> | Jaune | <input checked="" type="checkbox"/> | Jaune/Noir | <p><b>Data-Link (2 way)</b></p> <p>← <b>DL</b> →</p> <table border="0"> <tr><td><input checked="" type="checkbox"/></td><td>Brun/Blanc</td></tr> <tr><td><input checked="" type="checkbox"/></td><td>Gris</td></tr> <tr><td><input checked="" type="checkbox"/></td><td>Gris/Noir</td></tr> <tr><td><input checked="" type="checkbox"/></td><td>Brun</td></tr> </table> | <input checked="" type="checkbox"/> | Brun/Blanc | <input checked="" type="checkbox"/> | Gris | <input checked="" type="checkbox"/> | Gris/Noir | <input checked="" type="checkbox"/> | Brun |
| <input checked="" type="checkbox"/>  | Bleu pâle                           | <input checked="" type="checkbox"/> | Bleu pâle/Noir                      |                |                                     |       |                                     |            |                                     |      |                                     |           |                                     |      |                                     |      |                                     |        |                                     |             |                                     |       |                                     |            |                                     |       |                                     |            |   |                                     |            |                                     |      |                                     |           |                                     |      |  |                                     |           |                                     |                |                                     |       |                                     |            |                                     |      |                                     |           |                                     |      |                                     |      |                                     |        |                                     |             |                                     |       |                                     |            |                                     |       |                                     |            |   |                                     |            |                                     |      |                                     |           |                                     |      |
| <input checked="" type="checkbox"/>  | Blanc                               | <input checked="" type="checkbox"/> | Blanc/Noir                          |                |                                     |       |                                     |            |                                     |      |                                     |           |                                     |      |                                     |      |                                     |        |                                     |             |                                     |       |                                     |            |                                     |       |                                     |            |   |                                     |            |                                     |      |                                     |           |                                     |      |  |                                     |           |                                     |                |                                     |       |                                     |            |                                     |      |                                     |           |                                     |      |                                     |      |                                     |        |                                     |             |                                     |       |                                     |            |                                     |       |                                     |            |   |                                     |            |                                     |      |                                     |           |                                     |      |
| <input checked="" type="checkbox"/>  | Rose                                | <input checked="" type="checkbox"/> | Rose/Noir                           |                |                                     |       |                                     |            |                                     |      |                                     |           |                                     |      |                                     |      |                                     |        |                                     |             |                                     |       |                                     |            |                                     |       |                                     |            |   |                                     |            |                                     |      |                                     |           |                                     |      |  |                                     |           |                                     |                |                                     |       |                                     |            |                                     |      |                                     |           |                                     |      |                                     |      |                                     |        |                                     |             |                                     |       |                                     |            |                                     |       |                                     |            |   |                                     |            |                                     |      |                                     |           |                                     |      |
| <input checked="" type="checkbox"/>  | Bleu                                | <input checked="" type="checkbox"/> | Vert                                |                |                                     |       |                                     |            |                                     |      |                                     |           |                                     |      |                                     |      |                                     |        |                                     |             |                                     |       |                                     |            |                                     |       |                                     |            |   |                                     |            |                                     |      |                                     |           |                                     |      |  |                                     |           |                                     |                |                                     |       |                                     |            |                                     |      |                                     |           |                                     |      |                                     |      |                                     |        |                                     |             |                                     |       |                                     |            |                                     |       |                                     |            |   |                                     |            |                                     |      |                                     |           |                                     |      |
| <input checked="" type="checkbox"/>  | Orange                              | <input checked="" type="checkbox"/> | Orange/Noir                         |                |                                     |       |                                     |            |                                     |      |                                     |           |                                     |      |                                     |      |                                     |        |                                     |             |                                     |       |                                     |            |                                     |       |                                     |            |   |                                     |            |                                     |      |                                     |           |                                     |      |  |                                     |           |                                     |                |                                     |       |                                     |            |                                     |      |                                     |           |                                     |      |                                     |      |                                     |        |                                     |             |                                     |       |                                     |            |                                     |       |                                     |            |   |                                     |            |                                     |      |                                     |           |                                     |      |
| <input checked="" type="checkbox"/>  | Mauve                               | <input checked="" type="checkbox"/> | Mauve/Noir                          |                |                                     |       |                                     |            |                                     |      |                                     |           |                                     |      |                                     |      |                                     |        |                                     |             |                                     |       |                                     |            |                                     |       |                                     |            |   |                                     |            |                                     |      |                                     |           |                                     |      |  |                                     |           |                                     |                |                                     |       |                                     |            |                                     |      |                                     |           |                                     |      |                                     |      |                                     |        |                                     |             |                                     |       |                                     |            |                                     |       |                                     |            |   |                                     |            |                                     |      |                                     |           |                                     |      |
| <input checked="" type="checkbox"/>  | Jaune                               | <input checked="" type="checkbox"/> | Jaune/Noir                          |                |                                     |       |                                     |            |                                     |      |                                     |           |                                     |      |                                     |      |                                     |        |                                     |             |                                     |       |                                     |            |                                     |       |                                     |            |   |                                     |            |                                     |      |                                     |           |                                     |      |  |                                     |           |                                     |                |                                     |       |                                     |            |                                     |      |                                     |           |                                     |      |                                     |      |                                     |        |                                     |             |                                     |       |                                     |            |                                     |       |                                     |            |   |                                     |            |                                     |      |                                     |           |                                     |      |
| <input checked="" type="checkbox"/>  | Brun/Blanc                          |                                     |                                     |                |                                     |       |                                     |            |                                     |      |                                     |           |                                     |      |                                     |      |                                     |        |                                     |             |                                     |       |                                     |            |                                     |       |                                     |            |   |                                     |            |                                     |      |                                     |           |                                     |      |  |                                     |           |                                     |                |                                     |       |                                     |            |                                     |      |                                     |           |                                     |      |                                     |      |                                     |        |                                     |             |                                     |       |                                     |            |                                     |       |                                     |            |   |                                     |            |                                     |      |                                     |           |                                     |      |
| <input checked="" type="checkbox"/>  | Gris                                |                                     |                                     |                |                                     |       |                                     |            |                                     |      |                                     |           |                                     |      |                                     |      |                                     |        |                                     |             |                                     |       |                                     |            |                                     |       |                                     |            |   |                                     |            |                                     |      |                                     |           |                                     |      |  |                                     |           |                                     |                |                                     |       |                                     |            |                                     |      |                                     |           |                                     |      |                                     |      |                                     |        |                                     |             |                                     |       |                                     |            |                                     |       |                                     |            |   |                                     |            |                                     |      |                                     |           |                                     |      |
| <input checked="" type="checkbox"/>  | Gris/Noir                           |                                     |                                     |                |                                     |       |                                     |            |                                     |      |                                     |           |                                     |      |                                     |      |                                     |        |                                     |             |                                     |       |                                     |            |                                     |       |                                     |            |   |                                     |            |                                     |      |                                     |           |                                     |      |  |                                     |           |                                     |                |                                     |       |                                     |            |                                     |      |                                     |           |                                     |      |                                     |      |                                     |        |                                     |             |                                     |       |                                     |            |                                     |       |                                     |            |   |                                     |            |                                     |      |                                     |           |                                     |      |
| <input checked="" type="checkbox"/>  | Brun                                |                                     |                                     |                |                                     |       |                                     |            |                                     |      |                                     |           |                                     |      |                                     |      |                                     |        |                                     |             |                                     |       |                                     |            |                                     |       |                                     |            |   |                                     |            |                                     |      |                                     |           |                                     |      |  |                                     |           |                                     |                |                                     |       |                                     |            |                                     |      |                                     |           |                                     |      |                                     |      |                                     |        |                                     |             |                                     |       |                                     |            |                                     |       |                                     |            |   |                                     |            |                                     |      |                                     |           |                                     |      |
| <input checked="" type="checkbox"/>  | Bleu pâle                           | <input checked="" type="checkbox"/> | Bleu pâle/Noir                      |                |                                     |       |                                     |            |                                     |      |                                     |           |                                     |      |                                     |      |                                     |        |                                     |             |                                     |       |                                     |            |                                     |       |                                     |            |   |                                     |            |                                     |      |                                     |           |                                     |      |  |                                     |           |                                     |                |                                     |       |                                     |            |                                     |      |                                     |           |                                     |      |                                     |      |                                     |        |                                     |             |                                     |       |                                     |            |                                     |       |                                     |            |   |                                     |            |                                     |      |                                     |           |                                     |      |
| <input checked="" type="checkbox"/>  | Blanc                               | <input checked="" type="checkbox"/> | Blanc/Noir                          |                |                                     |       |                                     |            |                                     |      |                                     |           |                                     |      |                                     |      |                                     |        |                                     |             |                                     |       |                                     |            |                                     |       |                                     |            |   |                                     |            |                                     |      |                                     |           |                                     |      |  |                                     |           |                                     |                |                                     |       |                                     |            |                                     |      |                                     |           |                                     |      |                                     |      |                                     |        |                                     |             |                                     |       |                                     |            |                                     |       |                                     |            |   |                                     |            |                                     |      |                                     |           |                                     |      |
| <input checked="" type="checkbox"/>  | Rose                                | <input checked="" type="checkbox"/> | Rose/Noir                           |                |                                     |       |                                     |            |                                     |      |                                     |           |                                     |      |                                     |      |                                     |        |                                     |             |                                     |       |                                     |            |                                     |       |                                     |            |   |                                     |            |                                     |      |                                     |           |                                     |      |  |                                     |           |                                     |                |                                     |       |                                     |            |                                     |      |                                     |           |                                     |      |                                     |      |                                     |        |                                     |             |                                     |       |                                     |            |                                     |       |                                     |            |   |                                     |            |                                     |      |                                     |           |                                     |      |
| <input checked="" type="checkbox"/>  | Bleu                                | <input checked="" type="checkbox"/> | Vert                                |                |                                     |       |                                     |            |                                     |      |                                     |           |                                     |      |                                     |      |                                     |        |                                     |             |                                     |       |                                     |            |                                     |       |                                     |            |   |                                     |            |                                     |      |                                     |           |                                     |      |  |                                     |           |                                     |                |                                     |       |                                     |            |                                     |      |                                     |           |                                     |      |                                     |      |                                     |        |                                     |             |                                     |       |                                     |            |                                     |       |                                     |            |   |                                     |            |                                     |      |                                     |           |                                     |      |
| <input checked="" type="checkbox"/>  | Orange                              | <input checked="" type="checkbox"/> | Orange/Noir                         |                |                                     |       |                                     |            |                                     |      |                                     |           |                                     |      |                                     |      |                                     |        |                                     |             |                                     |       |                                     |            |                                     |       |                                     |            |   |                                     |            |                                     |      |                                     |           |                                     |      |  |                                     |           |                                     |                |                                     |       |                                     |            |                                     |      |                                     |           |                                     |      |                                     |      |                                     |        |                                     |             |                                     |       |                                     |            |                                     |       |                                     |            |   |                                     |            |                                     |      |                                     |           |                                     |      |
| <input checked="" type="checkbox"/>  | Mauve                               | <input checked="" type="checkbox"/> | Mauve/Noir                          |                |                                     |       |                                     |            |                                     |      |                                     |           |                                     |      |                                     |      |                                     |        |                                     |             |                                     |       |                                     |            |                                     |       |                                     |            |   |                                     |            |                                     |      |                                     |           |                                     |      |  |                                     |           |                                     |                |                                     |       |                                     |            |                                     |      |                                     |           |                                     |      |                                     |      |                                     |        |                                     |             |                                     |       |                                     |            |                                     |       |                                     |            |   |                                     |            |                                     |      |                                     |           |                                     |      |
| <input checked="" type="checkbox"/>  | Jaune                               | <input checked="" type="checkbox"/> | Jaune/Noir                          |                |                                     |       |                                     |            |                                     |      |                                     |           |                                     |      |                                     |      |                                     |        |                                     |             |                                     |       |                                     |            |                                     |       |                                     |            |   |                                     |            |                                     |      |                                     |           |                                     |      |  |                                     |           |                                     |                |                                     |       |                                     |            |                                     |      |                                     |           |                                     |      |                                     |      |                                     |        |                                     |             |                                     |       |                                     |            |                                     |       |                                     |            |   |                                     |            |                                     |      |                                     |           |                                     |      |
| <input checked="" type="checkbox"/>  | Brun/Blanc                          |                                     |                                     |                |                                     |       |                                     |            |                                     |      |                                     |           |                                     |      |                                     |      |                                     |        |                                     |             |                                     |       |                                     |            |                                     |       |                                     |            |   |                                     |            |                                     |      |                                     |           |                                     |      |  |                                     |           |                                     |                |                                     |       |                                     |            |                                     |      |                                     |           |                                     |      |                                     |      |                                     |        |                                     |             |                                     |       |                                     |            |                                     |       |                                     |            |   |                                     |            |                                     |      |                                     |           |                                     |      |
| <input checked="" type="checkbox"/>  | Gris                                |                                     |                                     |                |                                     |       |                                     |            |                                     |      |                                     |           |                                     |      |                                     |      |                                     |        |                                     |             |                                     |       |                                     |            |                                     |       |                                     |            |   |                                     |            |                                     |      |                                     |           |                                     |      |  |                                     |           |                                     |                |                                     |       |                                     |            |                                     |      |                                     |           |                                     |      |                                     |      |                                     |        |                                     |             |                                     |       |                                     |            |                                     |       |                                     |            |   |                                     |            |                                     |      |                                     |           |                                     |      |
| <input checked="" type="checkbox"/>  | Gris/Noir                           |                                     |                                     |                |                                     |       |                                     |            |                                     |      |                                     |           |                                     |      |                                     |      |                                     |        |                                     |             |                                     |       |                                     |            |                                     |       |                                     |            |   |                                     |            |                                     |      |                                     |           |                                     |      |  |                                     |           |                                     |                |                                     |       |                                     |            |                                     |      |                                     |           |                                     |      |                                     |      |                                     |        |                                     |             |                                     |       |                                     |            |                                     |       |                                     |            |   |                                     |            |                                     |      |                                     |           |                                     |      |
| <input checked="" type="checkbox"/>  | Brun                                |                                     |                                     |                |                                     |       |                                     |            |                                     |      |                                     |           |                                     |      |                                     |      |                                     |        |                                     |             |                                     |       |                                     |            |                                     |       |                                     |            |   |                                     |            |                                     |      |                                     |           |                                     |      |  |                                     |           |                                     |                |                                     |       |                                     |            |                                     |      |                                     |           |                                     |      |                                     |      |                                     |        |                                     |             |                                     |       |                                     |            |                                     |       |                                     |            |   |                                     |            |                                     |      |                                     |           |                                     |      |

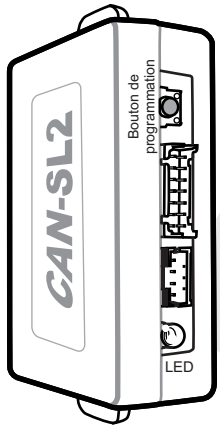

vue de face du module

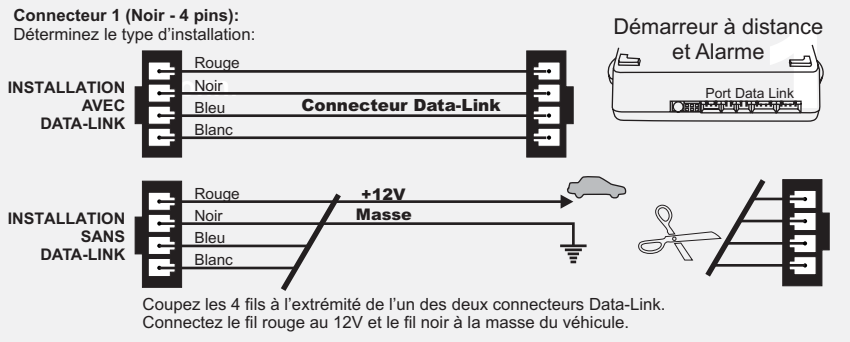

**1** **1.A** **Connecteur 1 (Noir):**  
Déterminez le type d'installation (**Data-Link** ou **non Data-Link**)  
Pour l'installation DATA-LINK assurez vous de la présence du connecteur DATA-LINK sur le démarreur..  
Pour installation non Data-Link voir INSTALLATION SANS DATA-LINK.

**1.B** **Connecteur 2 (Blanc):**  
Effectuez les branchements

**1.C** **Connecteur 3 (Blanc, situé au dos du module):**  
Effectuez les branchements

**2** **Maintenez le bouton de programmation enfoncé** en insérant le **connecteur 1** dans le CAN-SL2.  
Le DEL s'allume pour indiquer le début de la programmation, **relâchez le bouton de programmation.**

**3** Branchez le connecteur 2 (**CONN. 2**)  
**ATTENTION: Ne pas brancher le connecteur à l'envers.**

**4** Branchez le connecteur 3 (**CONN. 3**)

**5** Tournez la clef en position **ignition**.

**6** Lorsque le DEL clignote rapidement, **tournez la clef en position OFF.**  
**Le DEL s'éteint pour indiquer que le module est programmé.**

Branchement du filage au démarreur à distance/Alarme Branchement du filage au véhicule ○ SORTIE ● ENTRÉE