

Fonctionnal if equipped

- | | | | |
|---------------------------------|--|---|---|
| <input type="checkbox"/> Lock | <input type="checkbox"/> Tach | <input type="checkbox"/> Radio Off | <input type="checkbox"/> Heat Seats |
| <input type="checkbox"/> Unlock | <input type="checkbox"/> Start Enable | <input type="checkbox"/> Transponder Bypass | <input type="checkbox"/> Gas Door |
| <input type="checkbox"/> Arm | <input type="checkbox"/> Door Trigger | <input type="checkbox"/> PK3, Passlock | <input type="checkbox"/> Window Roll Down |
| <input type="checkbox"/> Disarm | <input type="checkbox"/> Trunk Trigger | <input type="checkbox"/> Sliding Door | <input type="checkbox"/> Hatch |
| <input type="checkbox"/> Trunk | <input type="checkbox"/> Hood Trigger | <input type="checkbox"/> Defrost | <input type="checkbox"/> Brake Signal |

WARNING: All Ignition and accessory wires of the remote starter must be connected at the ignition barrel.

WARNING: Every time the CAN-SL2 is disconnected, once reconnected the vehicle need to be started with the key.

Connection for Transponder bypass.

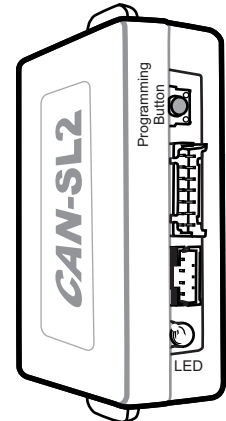

Front view of the module

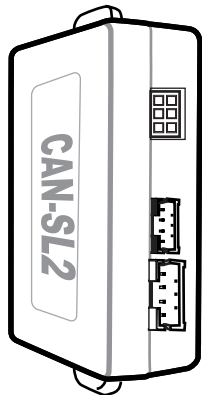

Back of the module

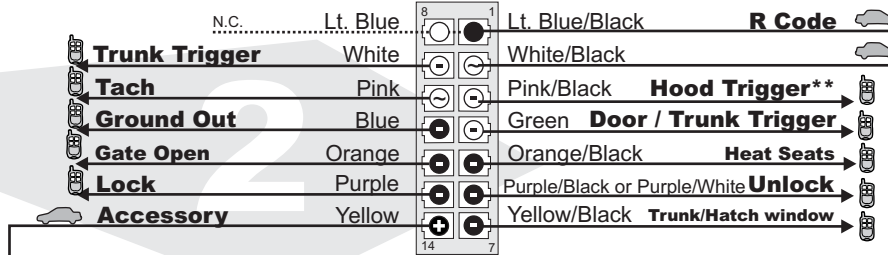

** Only if the vehicle is equipped with a hood pin.

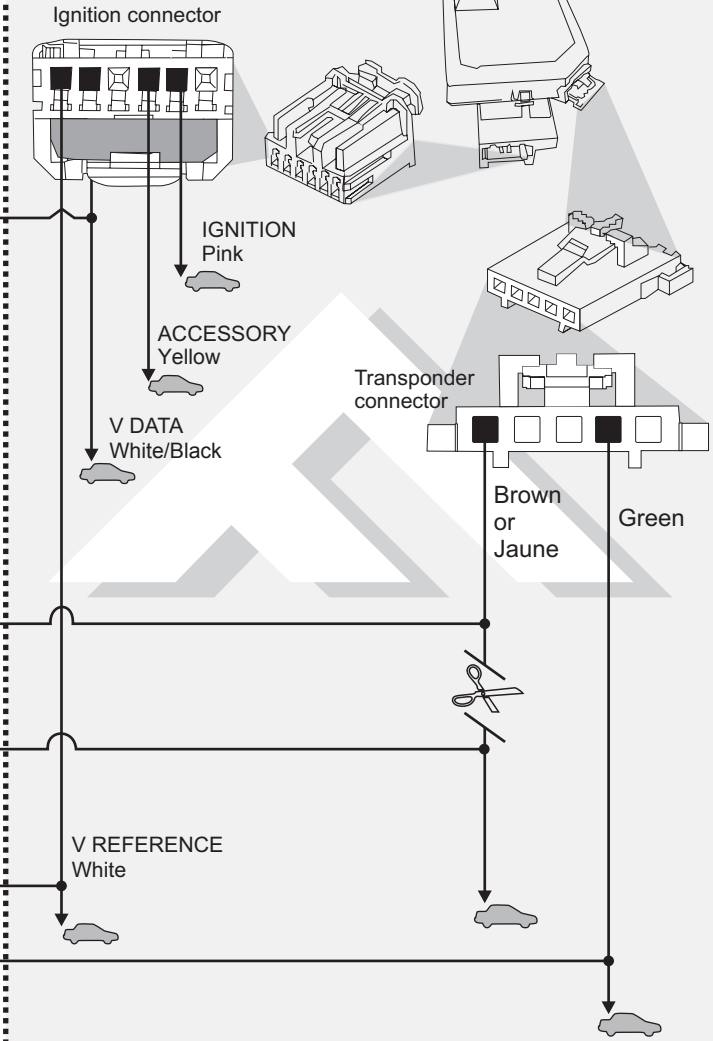

Connect wire to Remote-Starter/Alarm Connect wire to vehicle

○ OUTPUT ● INPUT

<p>Connect: ✓ Branchez: ✓</p> <table border="0"> <tr><td>Lt. Blue</td><td><input checked="" type="checkbox"/></td><td>Lt. Blue/Black</td><td><input checked="" type="checkbox"/></td></tr> <tr><td>White</td><td><input checked="" type="checkbox"/></td><td>White/Black</td><td><input checked="" type="checkbox"/></td></tr> <tr><td>Pink</td><td><input checked="" type="checkbox"/></td><td>Pink/Black</td><td><input checked="" type="checkbox"/></td></tr> <tr><td>Blue</td><td><input checked="" type="checkbox"/></td><td>Green</td><td><input checked="" type="checkbox"/></td></tr> <tr><td>Orange</td><td><input checked="" type="checkbox"/></td><td>Orange/Black</td><td><input checked="" type="checkbox"/></td></tr> <tr><td>Purple</td><td><input checked="" type="checkbox"/></td><td>Purple/Black</td><td><input checked="" type="checkbox"/></td></tr> <tr><td>Yellow</td><td><input checked="" type="checkbox"/></td><td>Yellow/Black</td><td><input checked="" type="checkbox"/></td></tr> </table>	Lt. Blue	<input checked="" type="checkbox"/>	Lt. Blue/Black	<input checked="" type="checkbox"/>	White	<input checked="" type="checkbox"/>	White/Black	<input checked="" type="checkbox"/>	Pink	<input checked="" type="checkbox"/>	Pink/Black	<input checked="" type="checkbox"/>	Blue	<input checked="" type="checkbox"/>	Green	<input checked="" type="checkbox"/>	Orange	<input checked="" type="checkbox"/>	Orange/Black	<input checked="" type="checkbox"/>	Purple	<input checked="" type="checkbox"/>	Purple/Black	<input checked="" type="checkbox"/>	Yellow	<input checked="" type="checkbox"/>	Yellow/Black	<input checked="" type="checkbox"/>	<p>Data-Link (1 way)</p> <p>DL →</p> <table border="0"> <tr><td>Brown/White</td><td><input checked="" type="checkbox"/></td></tr> <tr><td>Grey</td><td><input checked="" type="checkbox"/></td></tr> <tr><td>Grey/Black</td><td><input checked="" type="checkbox"/></td></tr> <tr><td>Brown</td><td><input checked="" type="checkbox"/></td></tr> </table>	Brown/White	<input checked="" type="checkbox"/>	Grey	<input checked="" type="checkbox"/>	Grey/Black	<input checked="" type="checkbox"/>	Brown	<input checked="" type="checkbox"/>	<p>Connect: ✓ Branchez: ✓</p> <table border="0"> <tr><td>Lt. Blue</td><td><input checked="" type="checkbox"/></td><td>Lt. Blue/Black</td><td><input checked="" type="checkbox"/></td></tr> <tr><td>White</td><td><input checked="" type="checkbox"/></td><td>White/Black</td><td><input checked="" type="checkbox"/></td></tr> <tr><td>Pink</td><td><input checked="" type="checkbox"/></td><td>Pink/Black</td><td><input checked="" type="checkbox"/></td></tr> <tr><td>Blue</td><td><input checked="" type="checkbox"/></td><td>Green</td><td><input checked="" type="checkbox"/></td></tr> <tr><td>Orange</td><td><input checked="" type="checkbox"/></td><td>Orange/Black</td><td><input checked="" type="checkbox"/></td></tr> <tr><td>Purple</td><td><input checked="" type="checkbox"/></td><td>Purple/Black</td><td><input checked="" type="checkbox"/></td></tr> <tr><td>Yellow</td><td><input checked="" type="checkbox"/></td><td>Yellow/Black</td><td><input checked="" type="checkbox"/></td></tr> </table>	Lt. Blue	<input checked="" type="checkbox"/>	Lt. Blue/Black	<input checked="" type="checkbox"/>	White	<input checked="" type="checkbox"/>	White/Black	<input checked="" type="checkbox"/>	Pink	<input checked="" type="checkbox"/>	Pink/Black	<input checked="" type="checkbox"/>	Blue	<input checked="" type="checkbox"/>	Green	<input checked="" type="checkbox"/>	Orange	<input checked="" type="checkbox"/>	Orange/Black	<input checked="" type="checkbox"/>	Purple	<input checked="" type="checkbox"/>	Purple/Black	<input checked="" type="checkbox"/>	Yellow	<input checked="" type="checkbox"/>	Yellow/Black	<input checked="" type="checkbox"/>	<p>Data-Link (2 way)</p> <p>← DL →</p> <table border="0"> <tr><td>Brown/White</td><td><input checked="" type="checkbox"/></td></tr> <tr><td>Grey</td><td><input checked="" type="checkbox"/></td></tr> <tr><td>Grey/Black</td><td><input checked="" type="checkbox"/></td></tr> <tr><td>Brown</td><td><input checked="" type="checkbox"/></td></tr> </table>	Brown/White	<input checked="" type="checkbox"/>	Grey	<input checked="" type="checkbox"/>	Grey/Black	<input checked="" type="checkbox"/>	Brown	<input checked="" type="checkbox"/>
Lt. Blue	<input checked="" type="checkbox"/>	Lt. Blue/Black	<input checked="" type="checkbox"/>																																																																								
White	<input checked="" type="checkbox"/>	White/Black	<input checked="" type="checkbox"/>																																																																								
Pink	<input checked="" type="checkbox"/>	Pink/Black	<input checked="" type="checkbox"/>																																																																								
Blue	<input checked="" type="checkbox"/>	Green	<input checked="" type="checkbox"/>																																																																								
Orange	<input checked="" type="checkbox"/>	Orange/Black	<input checked="" type="checkbox"/>																																																																								
Purple	<input checked="" type="checkbox"/>	Purple/Black	<input checked="" type="checkbox"/>																																																																								
Yellow	<input checked="" type="checkbox"/>	Yellow/Black	<input checked="" type="checkbox"/>																																																																								
Brown/White	<input checked="" type="checkbox"/>																																																																										
Grey	<input checked="" type="checkbox"/>																																																																										
Grey/Black	<input checked="" type="checkbox"/>																																																																										
Brown	<input checked="" type="checkbox"/>																																																																										
Lt. Blue	<input checked="" type="checkbox"/>	Lt. Blue/Black	<input checked="" type="checkbox"/>																																																																								
White	<input checked="" type="checkbox"/>	White/Black	<input checked="" type="checkbox"/>																																																																								
Pink	<input checked="" type="checkbox"/>	Pink/Black	<input checked="" type="checkbox"/>																																																																								
Blue	<input checked="" type="checkbox"/>	Green	<input checked="" type="checkbox"/>																																																																								
Orange	<input checked="" type="checkbox"/>	Orange/Black	<input checked="" type="checkbox"/>																																																																								
Purple	<input checked="" type="checkbox"/>	Purple/Black	<input checked="" type="checkbox"/>																																																																								
Yellow	<input checked="" type="checkbox"/>	Yellow/Black	<input checked="" type="checkbox"/>																																																																								
Brown/White	<input checked="" type="checkbox"/>																																																																										
Grey	<input checked="" type="checkbox"/>																																																																										
Grey/Black	<input checked="" type="checkbox"/>																																																																										
Brown	<input checked="" type="checkbox"/>																																																																										

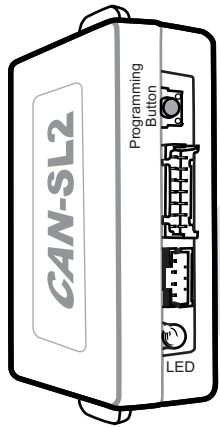

Front view of the module

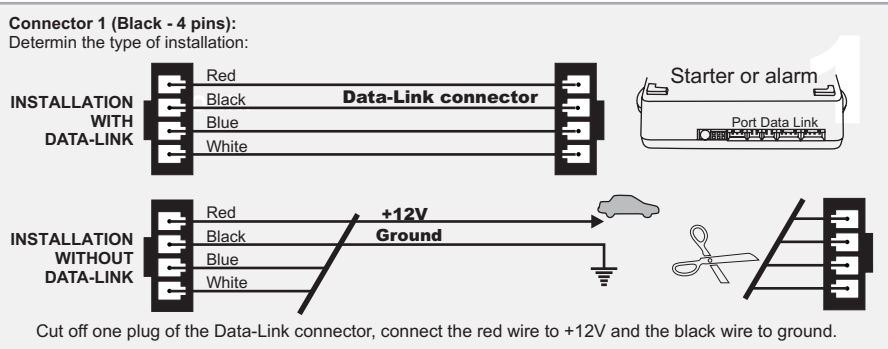

1 **1.A** **Make the connections of the CAN-SL2 to the vehicle:**

Connector 1 (Black):
Determine the type of installation:
INSTALLATION WITH DATA-LINK
INSTALLATION WITHOUT DATA-LINK

1.B **Connector 2 (White):**
Make the connections

1.C **Connector 3 (White, located at the back of the module):**
Make the connections

2 **Press the programming switch while inserting the main wires harness (CONN 1) into the CAN-SL2 module.**
The LED will illuminate to indicate you are in programming mode, release the programming button.

3 **Connect the other connectors (CONN. 2)**
WARNING: Connector 2 can be easily plugged in backwards.

4 **Connect the other connectors (CONN. 3)**

5 Turn the key to the "ON" position.

6 Once the LED starts to flash rapidly turn the key to the **OFF** position.
The LED will turn off to indicate the module has been programmed.
The module is now ready for use.

Connect wire to Remote-Starter/Alarm Connect wire to vehicle

○ OUTPUT ● INPUT

Fonctionnel si équipé

- | | | | |
|---|---|--|--|
| <input type="checkbox"/> Verrouillage | <input type="checkbox"/> Tach | <input type="checkbox"/> Radio Off | <input type="checkbox"/> Sièges chauffants |
| <input type="checkbox"/> Déverrouillage | <input type="checkbox"/> Active Démarreur | <input type="checkbox"/> Transponder Bypass | <input type="checkbox"/> Porte essence |
| <input type="checkbox"/> Armement | <input type="checkbox"/> Status de Porte | <input type="checkbox"/> PK3, Passlock | <input type="checkbox"/> Contrôle fenêtres |
| <input type="checkbox"/> Désarmement | <input type="checkbox"/> Status de Valise | <input type="checkbox"/> Portes Coulissantes | <input type="checkbox"/> Hayon arrière |
| <input type="checkbox"/> Valise | <input type="checkbox"/> Status de Capot | <input type="checkbox"/> Dégivrage | <input type="checkbox"/> Signal de Frein |

ATTENTION: Les fils d'ignition et d'accessoire du démarreur à distance doivent être connectés au barillet d'ignition.

ATTENTION: Chaque fois que le CAN-SL2 est débranché, une fois le module rebranché, démarrez le véhicule avec la clé.

Connexions pour le contournement transpondeur.

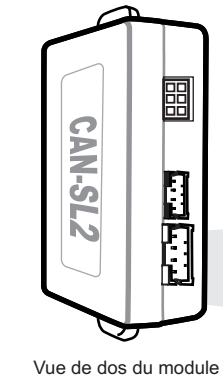
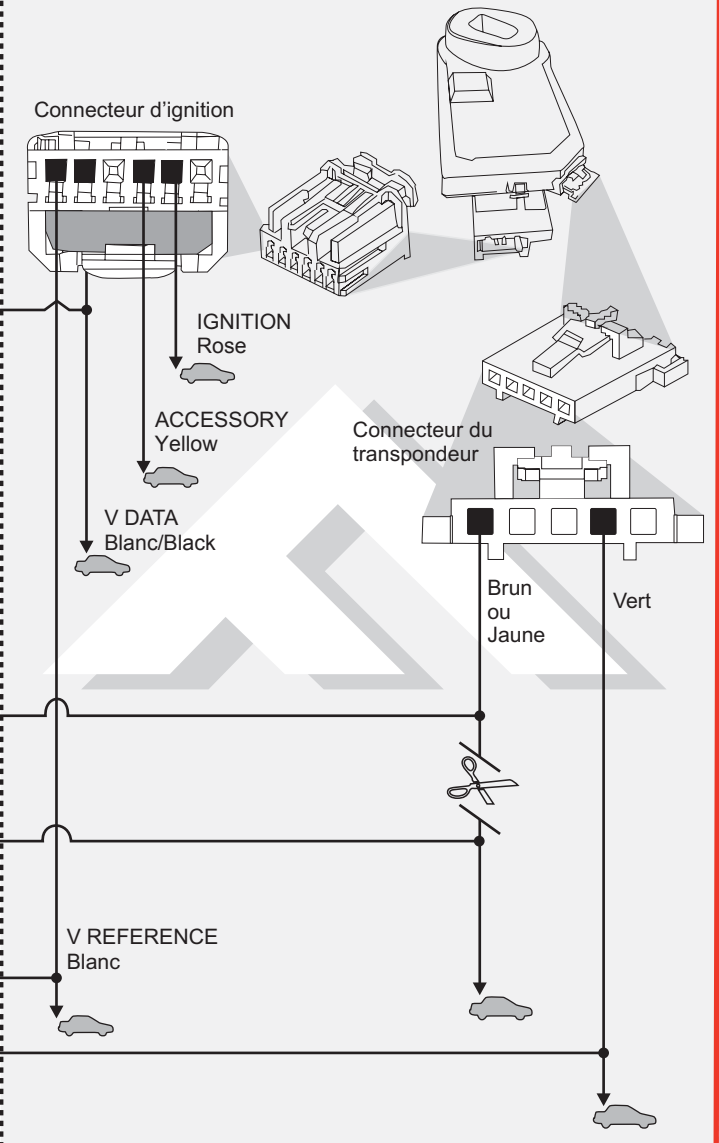
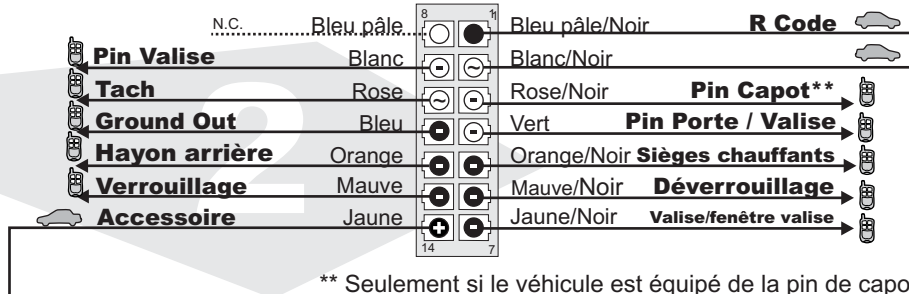
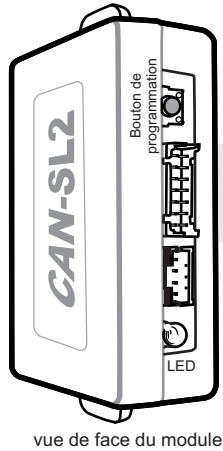

Branchement du filage au démarreur à distance/Alarme Branchement du filage au véhicule ○ SORTIE ● ENTRÉE

<p>Branchez: ✓</p> <table border="0"> <tr><td><input checked="" type="checkbox"/></td><td>Bleu pâle</td><td>8</td><td>1</td><td>Bleu pâle/Noir</td></tr> <tr><td><input checked="" type="checkbox"/></td><td>Blanc</td><td>9</td><td>2</td><td>Blanc/Noir</td></tr> <tr><td><input checked="" type="checkbox"/></td><td>Rose</td><td>10</td><td>3</td><td>Rose/Noir</td></tr> <tr><td><input checked="" type="checkbox"/></td><td>Bleu</td><td>11</td><td>4</td><td>Vert</td></tr> <tr><td><input checked="" type="checkbox"/></td><td>Orange</td><td>12</td><td>5</td><td>Orange/Noir</td></tr> <tr><td><input checked="" type="checkbox"/></td><td>Mauve</td><td>13</td><td>6</td><td>Mauve/Noir</td></tr> <tr><td><input checked="" type="checkbox"/></td><td>Jaune</td><td>14</td><td>7</td><td>Jaune/Noir</td></tr> </table>	<input checked="" type="checkbox"/>	Bleu pâle	8	1	Bleu pâle/Noir	<input checked="" type="checkbox"/>	Blanc	9	2	Blanc/Noir	<input checked="" type="checkbox"/>	Rose	10	3	Rose/Noir	<input checked="" type="checkbox"/>	Bleu	11	4	Vert	<input checked="" type="checkbox"/>	Orange	12	5	Orange/Noir	<input checked="" type="checkbox"/>	Mauve	13	6	Mauve/Noir	<input checked="" type="checkbox"/>	Jaune	14	7	Jaune/Noir	<p>Data-Link (1 way)</p> <p>DL →</p> <table border="0"> <tr><td><input checked="" type="checkbox"/></td><td>Brun/Blanc</td></tr> <tr><td><input checked="" type="checkbox"/></td><td>Gris</td></tr> <tr><td><input checked="" type="checkbox"/></td><td>Gris/Noir</td></tr> <tr><td><input checked="" type="checkbox"/></td><td>Brun</td></tr> </table>	<input checked="" type="checkbox"/>	Brun/Blanc	<input checked="" type="checkbox"/>	Gris	<input checked="" type="checkbox"/>	Gris/Noir	<input checked="" type="checkbox"/>	Brun	<p>Branchez: ✓</p> <table border="0"> <tr><td><input checked="" type="checkbox"/></td><td>Bleu pâle</td><td>8</td><td>1</td><td>Bleu pâle/Noir</td></tr> <tr><td><input checked="" type="checkbox"/></td><td>Blanc</td><td>9</td><td>2</td><td>Blanc/Noir</td></tr> <tr><td><input checked="" type="checkbox"/></td><td>Rose</td><td>10</td><td>3</td><td>Rose/Noir</td></tr> <tr><td><input checked="" type="checkbox"/></td><td>Bleu</td><td>11</td><td>4</td><td>Vert</td></tr> <tr><td><input checked="" type="checkbox"/></td><td>Orange</td><td>12</td><td>5</td><td>Orange/Noir</td></tr> <tr><td><input checked="" type="checkbox"/></td><td>Mauve</td><td>13</td><td>6</td><td>Mauve/Noir</td></tr> <tr><td><input checked="" type="checkbox"/></td><td>Jaune</td><td>14</td><td>7</td><td>Jaune/Noir</td></tr> </table>	<input checked="" type="checkbox"/>	Bleu pâle	8	1	Bleu pâle/Noir	<input checked="" type="checkbox"/>	Blanc	9	2	Blanc/Noir	<input checked="" type="checkbox"/>	Rose	10	3	Rose/Noir	<input checked="" type="checkbox"/>	Bleu	11	4	Vert	<input checked="" type="checkbox"/>	Orange	12	5	Orange/Noir	<input checked="" type="checkbox"/>	Mauve	13	6	Mauve/Noir	<input checked="" type="checkbox"/>	Jaune	14	7	Jaune/Noir	<p>Data-Link (2 way)</p> <p>← DL →</p> <table border="0"> <tr><td><input checked="" type="checkbox"/></td><td>Brun/Blanc</td></tr> <tr><td><input checked="" type="checkbox"/></td><td>Gris</td></tr> <tr><td><input checked="" type="checkbox"/></td><td>Gris/Noir</td></tr> <tr><td><input checked="" type="checkbox"/></td><td>Brun</td></tr> </table>	<input checked="" type="checkbox"/>	Brun/Blanc	<input checked="" type="checkbox"/>	Gris	<input checked="" type="checkbox"/>	Gris/Noir	<input checked="" type="checkbox"/>	Brun
<input checked="" type="checkbox"/>	Bleu pâle	8	1	Bleu pâle/Noir																																																																																					
<input checked="" type="checkbox"/>	Blanc	9	2	Blanc/Noir																																																																																					
<input checked="" type="checkbox"/>	Rose	10	3	Rose/Noir																																																																																					
<input checked="" type="checkbox"/>	Bleu	11	4	Vert																																																																																					
<input checked="" type="checkbox"/>	Orange	12	5	Orange/Noir																																																																																					
<input checked="" type="checkbox"/>	Mauve	13	6	Mauve/Noir																																																																																					
<input checked="" type="checkbox"/>	Jaune	14	7	Jaune/Noir																																																																																					
<input checked="" type="checkbox"/>	Brun/Blanc																																																																																								
<input checked="" type="checkbox"/>	Gris																																																																																								
<input checked="" type="checkbox"/>	Gris/Noir																																																																																								
<input checked="" type="checkbox"/>	Brun																																																																																								
<input checked="" type="checkbox"/>	Bleu pâle	8	1	Bleu pâle/Noir																																																																																					
<input checked="" type="checkbox"/>	Blanc	9	2	Blanc/Noir																																																																																					
<input checked="" type="checkbox"/>	Rose	10	3	Rose/Noir																																																																																					
<input checked="" type="checkbox"/>	Bleu	11	4	Vert																																																																																					
<input checked="" type="checkbox"/>	Orange	12	5	Orange/Noir																																																																																					
<input checked="" type="checkbox"/>	Mauve	13	6	Mauve/Noir																																																																																					
<input checked="" type="checkbox"/>	Jaune	14	7	Jaune/Noir																																																																																					
<input checked="" type="checkbox"/>	Brun/Blanc																																																																																								
<input checked="" type="checkbox"/>	Gris																																																																																								
<input checked="" type="checkbox"/>	Gris/Noir																																																																																								
<input checked="" type="checkbox"/>	Brun																																																																																								

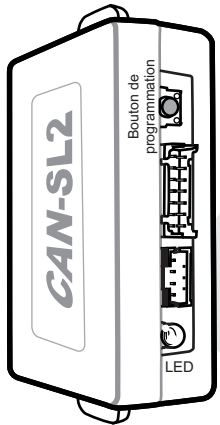

vue de face du module

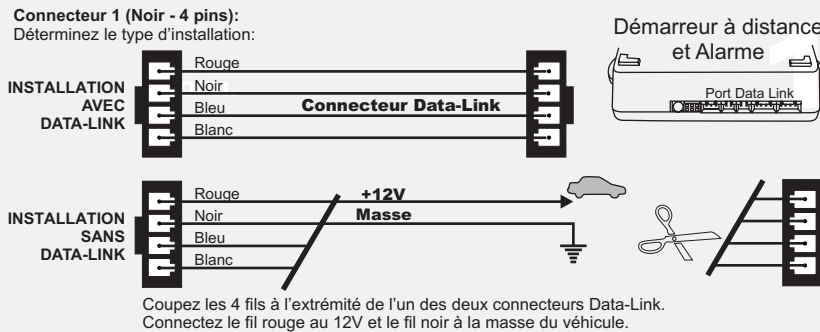

1 **1.A** **Connecteur 1 (Noir):**
Déterminez le type d'installation (**Data-Link** ou **non Data-Link**)
Pour l'installation DATA-LINK assurez vous de la présence du connecteur DATA-LINK sur le démarreur..
Pour installation non Data-Link voir INSTALLATION SANS DATA-LINK.

1.B **Connecteur 2 (Blanc):**
Effectuez les branchements

1.C **Connecteur 3 (Blanc, situé au dos du module):**
Effectuez les branchements

2 **Maintenez le bouton de programmation enfoncé** en insérant le **connecteur 1** dans le CAN-SL2.
Le DEL s'allume pour indiquer le début de la programmation, **relâchez le bouton de programmation.**

3 Branchez le connecteur 2 (**CONN. 2**)
ATTENTION: Ne pas brancher le connecteur à l'envers.

4 Branchez le connecteur 3 (**CONN. 3**)

5 Tournez la clef en position **ignition**.

6 Lorsque le DEL clignote rapidement, **tournez la clef en position OFF.**
Le DEL s'éteint pour indiquer que le module est programmé.

Branchement du filage au démarreur à distance/Alarme Branchement du filage au véhicule ○ SORTIE ● ENTRÉE