



LINCOLN MKZ

2007-2008



CAN-SL2

Made in Canada Rev. A - 14 / 01 / 2009
Web site: <http://www.ifar.ca>

ALARM AND REMOTE STARTER CAN BUS INTERFACE KIT

Fonctionnal if equipped

<input checked="" type="checkbox"/> Lock	<input checked="" type="checkbox"/> Tach	<input checked="" type="checkbox"/> Radio Off	<input type="checkbox"/> Heat Seats
<input checked="" type="checkbox"/> Unlock	<input checked="" type="checkbox"/> Start Enable	<input type="checkbox"/> Transponder Bypass	<input type="checkbox"/> Gas Door
<input checked="" type="checkbox"/> Arm	<input checked="" type="checkbox"/> Door Trigger	<input type="checkbox"/> PK3, Passlock	<input type="checkbox"/> Window Roll Down
<input checked="" type="checkbox"/> Disarm	<input checked="" type="checkbox"/> Trunk Trigger	<input type="checkbox"/> Sliding Door	<input type="checkbox"/> Hatch
<input checked="" type="checkbox"/> Trunk	<input type="checkbox"/> Hood Trigger	<input type="checkbox"/> Defrost	<input type="checkbox"/> Brake Signal

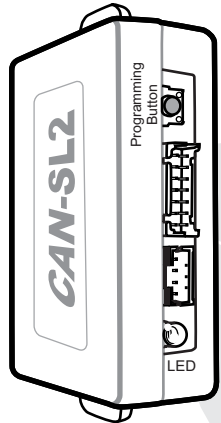

Front of the module

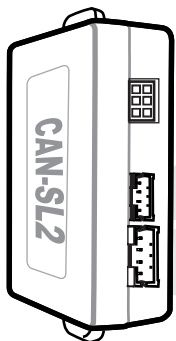
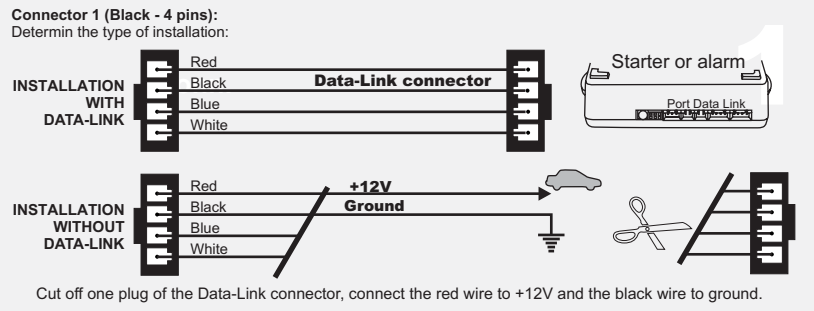
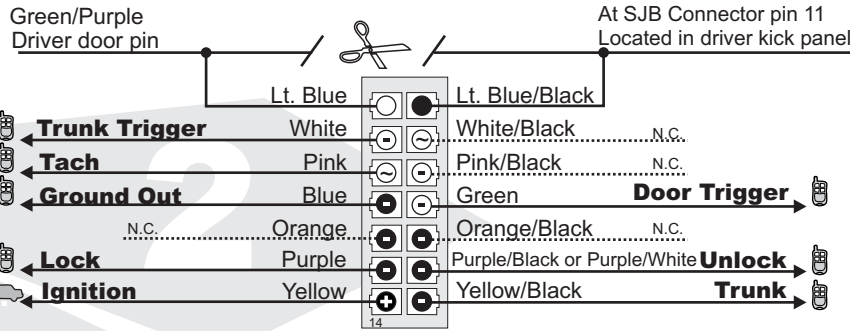

Back of the module

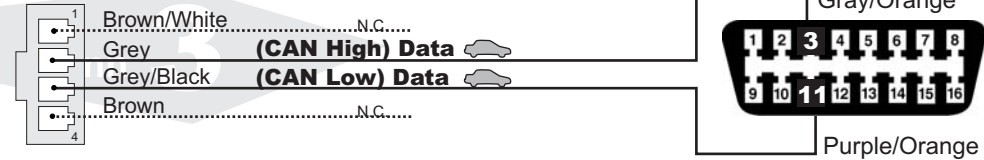
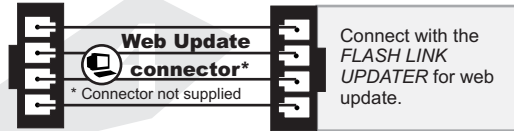

Connect wire to Remote-Starter/Alarm
 Connect wire to vehicle
 ○ OUTPUT ● INPUT

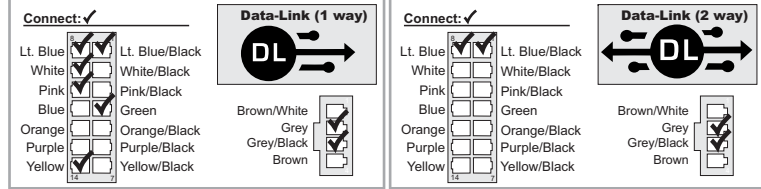

- 1** **1.A** **Connector 1 (Black):**
Determine the type of installation:
INSTALLATION WITH DATA-LINK
INSTALLATION WITHOUT DATA-LINK
- 1.B** **Connector 2 (White):**
Make the connections
- 1.C** **Connector 3 (White, located at the back of the module):**
Make the connections
- 2** **Press** the programming switch while inserting the main wires harness (**CONN 1**) into the CAN-SL2 module. The LED will illuminate to indicate you are in programming mode, release the programming button.
- 3** **Connect** the other connectors (**CONN. 2**)
WARNING: Connector 2 can be easily plugged in backwards.
- 4** **Connect** the other connectors (**CONN. 3**)
- 5** Turn the key to the "ON" position.
- 6** Once the LED starts to flash rapidly turn the key to the **OFF** position.
The LED will turn off to indicate the module has been programmed.
The module is now ready for use.



Technical support:
 TEL: 514-255-HELP (4357)
 FAX: 514-255-1367
 Web: www.ifar.ca

Neither the manufacturer or distributor of this module is responsible of damages of any kind indirectly or directly caused by this module, except for the replacement of this module in case of manufacturing defects. This module must be install by qualified technician. This instruction guide may change without notice. Visit www.ifar.ca to get latest version.

Fonctionnel si équipé

<input checked="" type="checkbox"/> Verrouillage	<input checked="" type="checkbox"/> Tach	<input checked="" type="checkbox"/> Radio Off	<input type="checkbox"/> Sièges chauffants
<input checked="" type="checkbox"/> Déverrouillage	<input checked="" type="checkbox"/> Active Démarreur	<input checked="" type="checkbox"/> Transponder Bypass	<input type="checkbox"/> Porte essence
<input checked="" type="checkbox"/> Armement	<input checked="" type="checkbox"/> Status de Porte	<input type="checkbox"/> PK3, Passlock	<input type="checkbox"/> Contrôle portes
<input checked="" type="checkbox"/> Désarmement	<input checked="" type="checkbox"/> Status de Valise	<input type="checkbox"/> Portes Coulissantes	<input type="checkbox"/> Hayon arrière
<input checked="" type="checkbox"/> Valise	<input type="checkbox"/> Status de Capot	<input type="checkbox"/> Dégivrage	<input type="checkbox"/> Signal de Frein

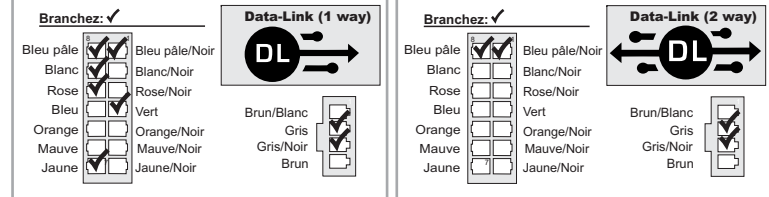
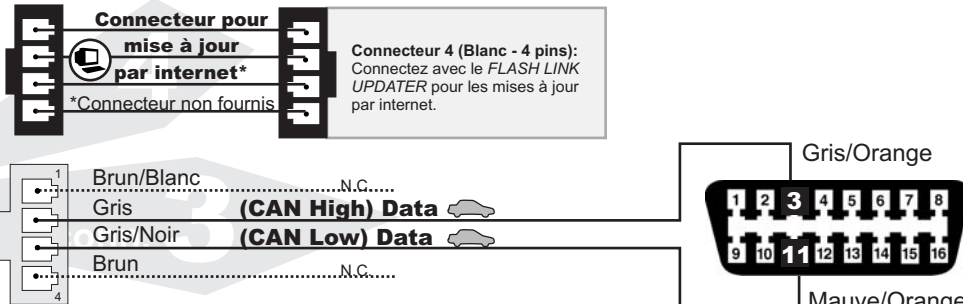
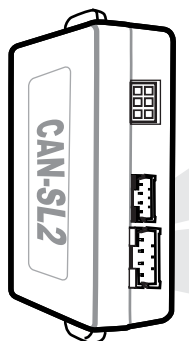
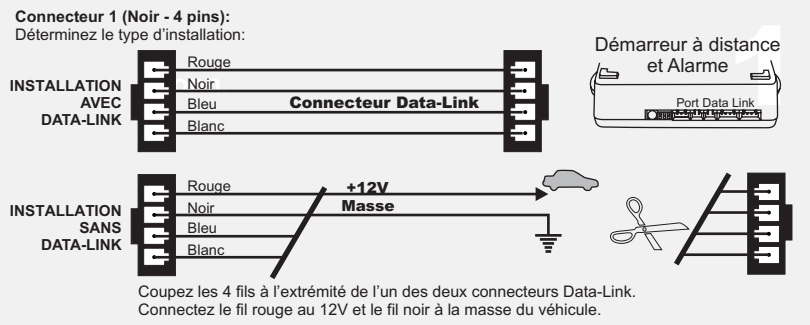
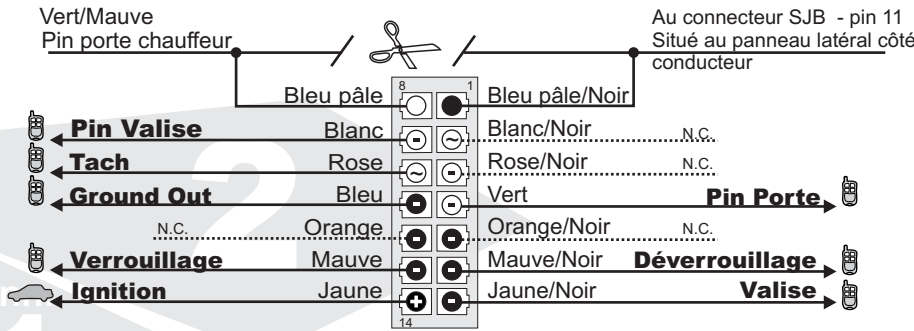
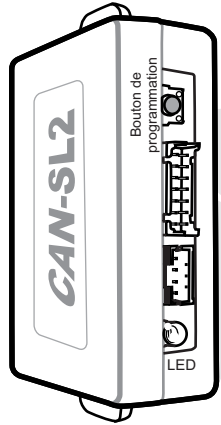

1 Effectuez les connexions du CAN-SL2 au véhicule:

1.A Connecteur 1 (Noir): Déterminez le type d'installation (Data-Link ou non Data-Link) Pour l'installation DATA-LINK assurez vous de la présence du connecteur DATA-LINK sur le démarreur.. Pour installation non Data-Link voir INSTALLATION SANS DATA-LINK.

1.B Connecteur 2 (Blanc): Effectuez les branchements

1.C Connecteur 3 (Blanc, situé au dos du module): Effectuez les branchements

2 Maintenez le bouton de programmation enfoncé en insérant le connecteur 1 dans le CAN-SL2. Le DEL s'allume pour indiquer le début de la programmation, relâchez le bouton de programmation.

3 Branchez le connecteur 2 (CONN. 2) ATTENTION: Ne pas brancher le connecteur à l'envers.

4 Branchez le connecteur 3 (CONN. 3)

5 Tournez la clef en position ignition.

6 Lorsque le DEL clignote rapidement, tournez la clef en position OFF. Le DEL s'éteint pour indiquer que le module est programmé.

Branchement du filage au démarreur à distance/Alarme Branchement du filage au véhicule ○ SORTIE ● ENTRÉE