

**Fonctionnal if equipped**

- |  |   |   |   |
|--|---|---|---|
| <input checked="" type="checkbox"/> Lock   | <input type="checkbox"/> Tach                     | <input type="checkbox"/> Radio Off          | <input type="checkbox"/> Heat Seats       |
| <input checked="" type="checkbox"/> Unlock | <input checked="" type="checkbox"/> Start Enable  | <input type="checkbox"/> Transponder Bypass | <input type="checkbox"/> Gas Door         |
| <input checked="" type="checkbox"/> Arm    | <input checked="" type="checkbox"/> Door Trigger  | <input type="checkbox"/> PK3, Passlock      | <input type="checkbox"/> Window Roll Down |
| <input checked="" type="checkbox"/> Disarm | <input checked="" type="checkbox"/> Trunk Trigger | <input type="checkbox"/> Sliding Door       | <input type="checkbox"/> Hatch            |
| <input checked="" type="checkbox"/> Trunk  | <input type="checkbox"/> Hood Trigger             | <input type="checkbox"/> Defrost            | <input type="checkbox"/> Brake Signal     |

**Remote-Starter Connection for Transponder bypass**

**WARNING:** All Ignition and accessory wires of the remote starter must be connected at the ignition connector.

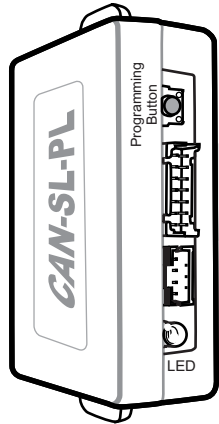

Front of the module

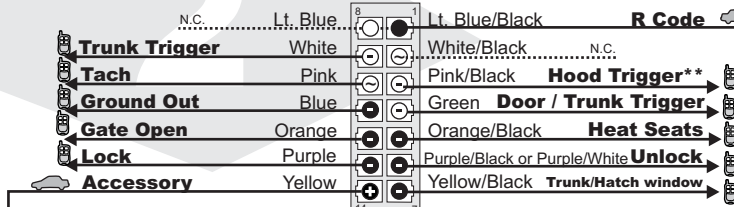
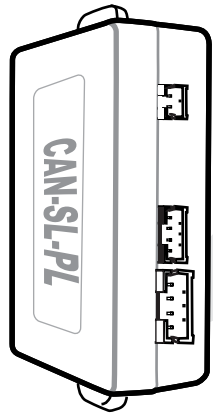

\*\* Only if the vehicle is equipped with a hood pin.

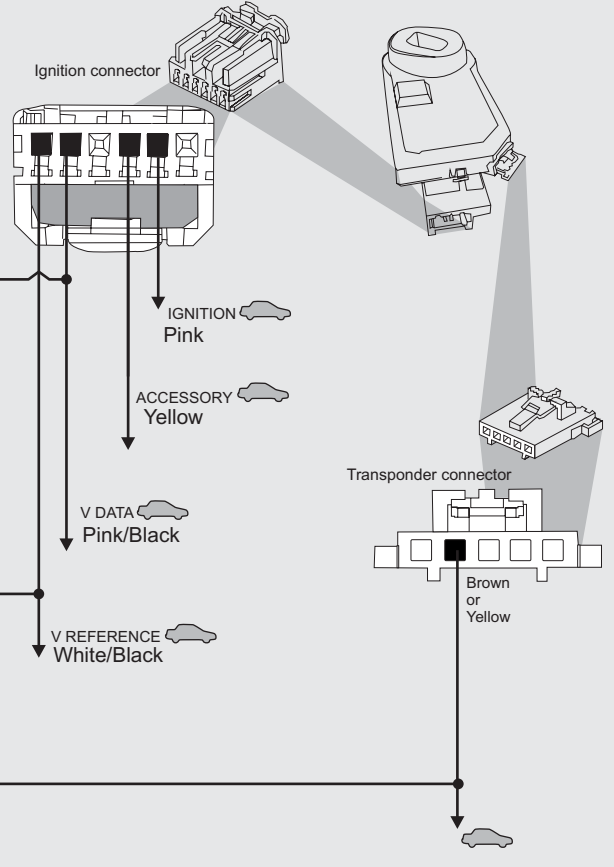
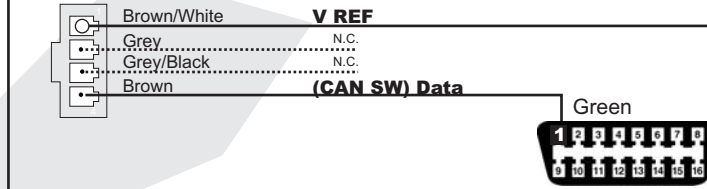

Connect wire to Remote-Starter/Alarm Connect wire to vehicle

○ OUTPUT ● INPUT

Connect: ✓ Branchez: ✓

Lt. Blue	<input checked="" type="checkbox"/>	Lt. Blue/Black	<input checked="" type="checkbox"/>
White	<input checked="" type="checkbox"/>	White/Black	<input checked="" type="checkbox"/>
Pink	<input checked="" type="checkbox"/>	Pink/Black	<input checked="" type="checkbox"/>
Blue	<input checked="" type="checkbox"/>	Green	<input checked="" type="checkbox"/>
Orange	<input checked="" type="checkbox"/>	Orange/Black	<input checked="" type="checkbox"/>
Purple	<input checked="" type="checkbox"/>	Purple/Black	<input checked="" type="checkbox"/>
Yellow	<input checked="" type="checkbox"/>	Yellow/Black	<input checked="" type="checkbox"/>

**Data-Link (1 way)**



Brown/White	<input checked="" type="checkbox"/>
Grey	<input checked="" type="checkbox"/>
Grey/Black	<input checked="" type="checkbox"/>
Brown	<input checked="" type="checkbox"/>

Connect: ✓ Branchez: ✓

Lt. Blue	<input checked="" type="checkbox"/>	Lt. Blue/Black	<input checked="" type="checkbox"/>
White	<input checked="" type="checkbox"/>	White/Black	<input checked="" type="checkbox"/>
Pink	<input checked="" type="checkbox"/>	Pink/Black	<input checked="" type="checkbox"/>
Blue	<input checked="" type="checkbox"/>	Green	<input checked="" type="checkbox"/>
Orange	<input checked="" type="checkbox"/>	Orange/Black	<input checked="" type="checkbox"/>
Purple	<input checked="" type="checkbox"/>	Purple/Black	<input checked="" type="checkbox"/>
Yellow	<input checked="" type="checkbox"/>	Yellow/Black	<input checked="" type="checkbox"/>

**Data-Link (2 way)**



Brown/White	<input checked="" type="checkbox"/>
Grey	<input checked="" type="checkbox"/>
Grey/Black	<input checked="" type="checkbox"/>
Brown	<input checked="" type="checkbox"/>

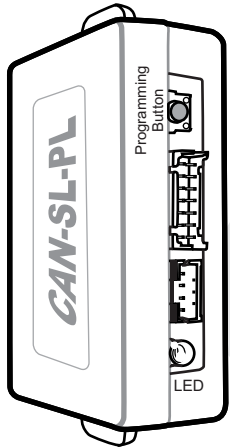

Front of the module

**Connector 1 (Black - 4 pins):**  
Determine the type of installation:

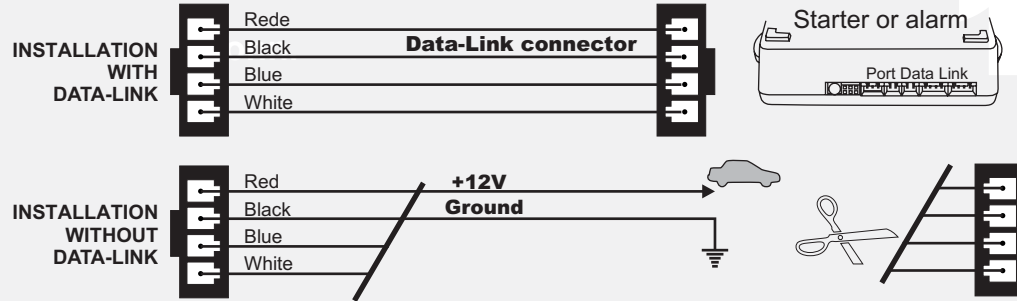

Cut off one plug of the Data-Link connector, connect the red wire to +12V and the black wire to ground.

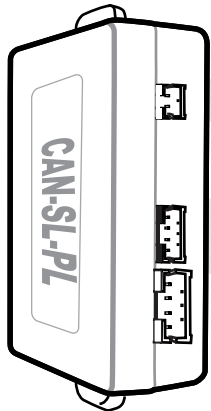

PATS-LINK

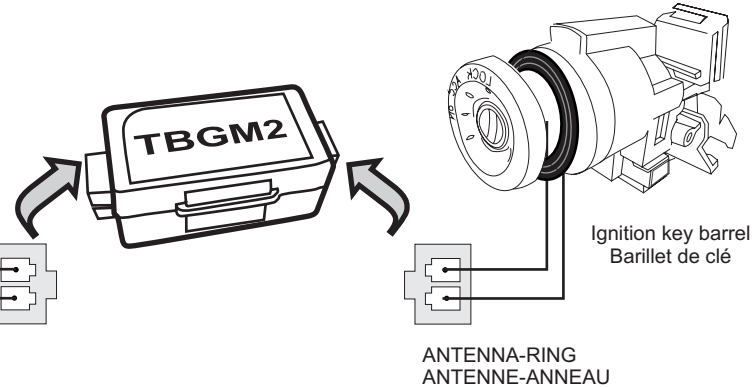

Ignition key barrel  
Barillet de clé

ANTENNA-RING  
ANTENNE-ANNEAU



**Connector 4 (White - 4 pins):**  
Connect with the *FLASH LINK UPDATER* for web update.

**Web Update connector\***  
\* Connector not supplied

Connect wire to Remote-Starter/Alarm Connect wire to vehicle

○ OUTPUT ● INPUT

## CAN-SL-PL PROGRAMMING

**1** **1.A**  **Make the connections of the CAN-SL-PL to the vehicle:**

**Connector 1 (Black):**  
Determine the type of installation:  
INSTALLATION WITH DATA-LINK  
INSTALLATION WITHOUT DATA-LINK

**1.B**  **Connector 2 (White):**  
Make the connections

**1.C**  **Connector 3 (White, located at the back of the module):**  
Make the connections

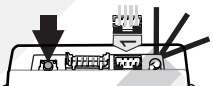
**2**  **Press** the programming switch while inserting the main wires harness (**CONN 1**) into the CAN-SL-PL module. The LED will illuminate to indicate you are in programming mode, release the programming button.

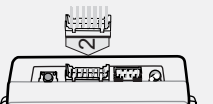
**3**  **Connect** the other connectors (**CONN. 2**)  
**WARNING: Connector 2 can be easily plugged in backwards.**

**4**  **Connect** the other connectors (**CONN. 3**)

**5**  Turn the key to the **"ON" position**.

**6**  Once the LED starts to flash rapidly turn the key to the **OFF position**.

The LED will turn off to indicate the module has been programmed.

**The module is now ready for use.**

## TBGM2 PROGRAMMING

**7**  Insert the key and turn the cylinder to the **ON/RUN** position for **1 second**.

**8**  Remove the key.

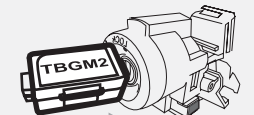
**9**  Place the TBGM2 module close to the front of the ignition barrel.

**YOU HAVE 5 SECONDS TO COMPLETE THE FOLLOWING STEP**

**10**  Remote-Start the vehicle. **THE TBGM2 IS NOW PROGRAMMED.**

**IMPORTANT:**  
Once the **TBGM2** is programmed, it can not be programmed on another vehicle.

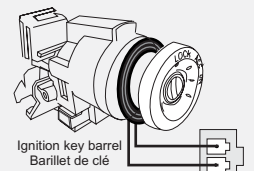
**11**  **Remove the trim cap from the ignition barrel.**  
**Stick the antenna to the ignition barrel.**  
**Replace the trim cap on the ignition barrel.**

**12**  Connect the TBGM2 module to the CAN-SL-PL using the PATS-LINK cable.

Fonctionnel if equipped

- |  |  |   |  |
|--|--|---|--|
| <input checked="" type="checkbox"/> Verrouillage   | <input type="checkbox"/> Tach                        | <input type="checkbox"/> Radio Off          | <input type="checkbox"/> Sièges chauffants |
| <input checked="" type="checkbox"/> Déverrouillage | <input checked="" type="checkbox"/> Active Démarreur | <input type="checkbox"/> Transponder Bypass | <input type="checkbox"/> Porte essence     |
| <input checked="" type="checkbox"/> Armement       | <input checked="" type="checkbox"/> Status de Porte  | <input type="checkbox"/> PK3, Passlock      | <input type="checkbox"/> Contrôle portes   |
| <input checked="" type="checkbox"/> Désarmement    | <input checked="" type="checkbox"/> Status de Valise | <input type="checkbox"/> Portes Couissantes | <input type="checkbox"/> Hayon arrière     |
| <input checked="" type="checkbox"/> Valise         | <input type="checkbox"/> Status de Capot             | <input type="checkbox"/> Dégivrage          | <input type="checkbox"/> Signal de Frein   |

Démarreur à distance Connexion pour le contournement transpondeur.

**ATTENTION:** Les fils d'ignition et d'accessoire du démarreur à distance doivent être connectés au connecteur d'ignition.

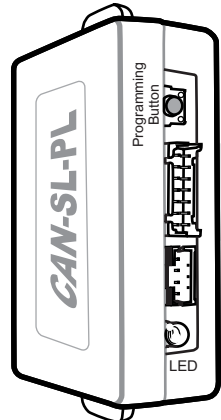

Module vue de face

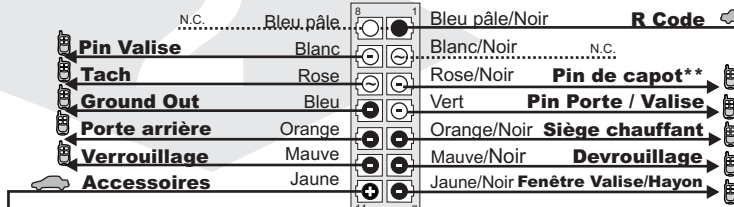
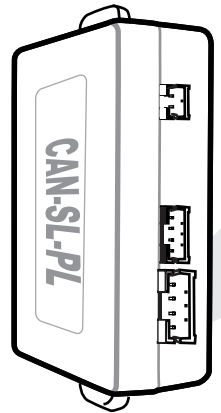

\*\* Seulement si le véhicule est équipé de la pin de capot.

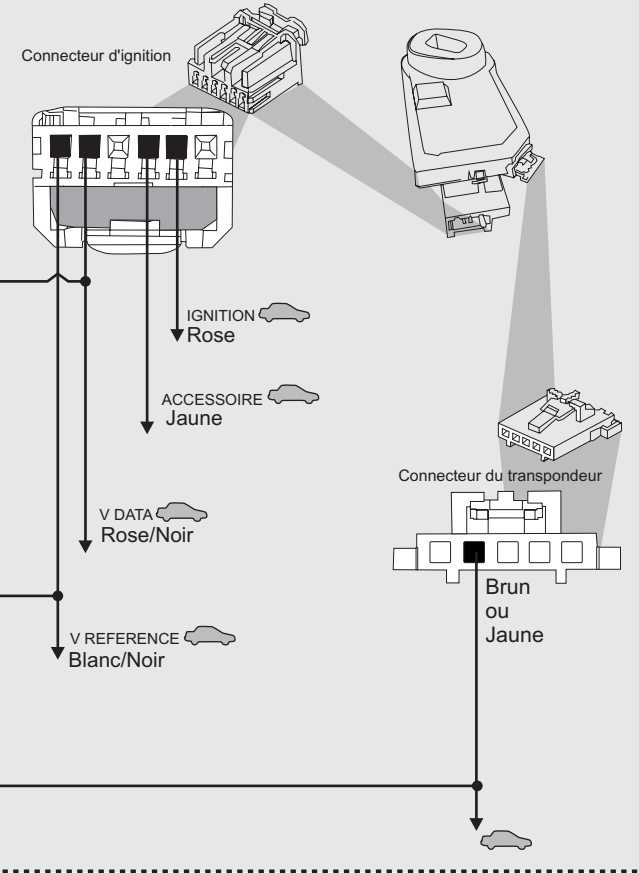
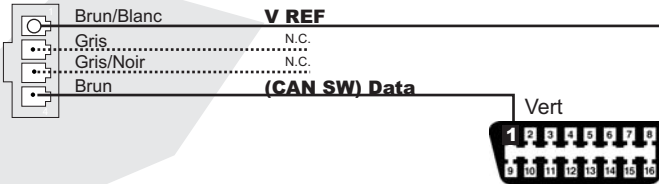

Branchement du filage au démarreur à distance/Alarme Branchement du filage au véhicule ○ SORTIE ● ENTRÉE

<p>Branchez: ✓</p> <table border="0"> <tr><td>Bleu pâle</td><td><input checked="" type="checkbox"/></td><td>1</td><td>Bleu pâle/Noir</td></tr> <tr><td>Blanc</td><td><input checked="" type="checkbox"/></td><td>2</td><td>Blanc/Noir</td></tr> <tr><td>Rose</td><td><input checked="" type="checkbox"/></td><td>3</td><td>Rose/Noir</td></tr> <tr><td>Bleu</td><td><input checked="" type="checkbox"/></td><td>4</td><td>Vert</td></tr> <tr><td>Orange</td><td><input type="checkbox"/></td><td>5</td><td>Orange/Noir</td></tr> <tr><td>Mauve</td><td><input type="checkbox"/></td><td>6</td><td>Mauve/Noir</td></tr> <tr><td>Jaune</td><td><input type="checkbox"/></td><td>7</td><td>Jaune/Noir</td></tr> </table>	Bleu pâle	<input checked="" type="checkbox"/>	1	Bleu pâle/Noir	Blanc	<input checked="" type="checkbox"/>	2	Blanc/Noir	Rose	<input checked="" type="checkbox"/>	3	Rose/Noir	Bleu	<input checked="" type="checkbox"/>	4	Vert	Orange	<input type="checkbox"/>	5	Orange/Noir	Mauve	<input type="checkbox"/>	6	Mauve/Noir	Jaune	<input type="checkbox"/>	7	Jaune/Noir	<p><b>Data-Link (1 way)</b></p> <p><b>DL</b></p> <table border="0"> <tr><td>Brun/Blanc</td><td><input checked="" type="checkbox"/></td></tr> <tr><td>Gris</td><td><input checked="" type="checkbox"/></td></tr> <tr><td>Gris/Noir</td><td><input checked="" type="checkbox"/></td></tr> <tr><td>Brun</td><td><input type="checkbox"/></td></tr> </table>	Brun/Blanc	<input checked="" type="checkbox"/>	Gris	<input checked="" type="checkbox"/>	Gris/Noir	<input checked="" type="checkbox"/>	Brun	<input type="checkbox"/>	<p>Branchez: ✓</p> <table border="0"> <tr><td>Bleu pâle</td><td><input checked="" type="checkbox"/></td><td>1</td><td>Bleu pâle/Noir</td></tr> <tr><td>Blanc</td><td><input checked="" type="checkbox"/></td><td>2</td><td>Blanc/Noir</td></tr> <tr><td>Rose</td><td><input checked="" type="checkbox"/></td><td>3</td><td>Rose/Noir</td></tr> <tr><td>Bleu</td><td><input checked="" type="checkbox"/></td><td>4</td><td>Vert</td></tr> <tr><td>Orange</td><td><input type="checkbox"/></td><td>5</td><td>Orange/Noir</td></tr> <tr><td>Mauve</td><td><input type="checkbox"/></td><td>6</td><td>Mauve/Noir</td></tr> <tr><td>Jaune</td><td><input type="checkbox"/></td><td>7</td><td>Jaune/Noir</td></tr> </table>	Bleu pâle	<input checked="" type="checkbox"/>	1	Bleu pâle/Noir	Blanc	<input checked="" type="checkbox"/>	2	Blanc/Noir	Rose	<input checked="" type="checkbox"/>	3	Rose/Noir	Bleu	<input checked="" type="checkbox"/>	4	Vert	Orange	<input type="checkbox"/>	5	Orange/Noir	Mauve	<input type="checkbox"/>	6	Mauve/Noir	Jaune	<input type="checkbox"/>	7	Jaune/Noir	<p><b>Data-Link (2 way)</b></p> <p><b>DL</b></p> <table border="0"> <tr><td>Brun/Blanc</td><td><input checked="" type="checkbox"/></td></tr> <tr><td>Gris</td><td><input checked="" type="checkbox"/></td></tr> <tr><td>Gris/Noir</td><td><input checked="" type="checkbox"/></td></tr> <tr><td>Brun</td><td><input type="checkbox"/></td></tr> </table>	Brun/Blanc	<input checked="" type="checkbox"/>	Gris	<input checked="" type="checkbox"/>	Gris/Noir	<input checked="" type="checkbox"/>	Brun	<input type="checkbox"/>
Bleu pâle	<input checked="" type="checkbox"/>	1	Bleu pâle/Noir																																																																								
Blanc	<input checked="" type="checkbox"/>	2	Blanc/Noir																																																																								
Rose	<input checked="" type="checkbox"/>	3	Rose/Noir																																																																								
Bleu	<input checked="" type="checkbox"/>	4	Vert																																																																								
Orange	<input type="checkbox"/>	5	Orange/Noir																																																																								
Mauve	<input type="checkbox"/>	6	Mauve/Noir																																																																								
Jaune	<input type="checkbox"/>	7	Jaune/Noir																																																																								
Brun/Blanc	<input checked="" type="checkbox"/>																																																																										
Gris	<input checked="" type="checkbox"/>																																																																										
Gris/Noir	<input checked="" type="checkbox"/>																																																																										
Brun	<input type="checkbox"/>																																																																										
Bleu pâle	<input checked="" type="checkbox"/>	1	Bleu pâle/Noir																																																																								
Blanc	<input checked="" type="checkbox"/>	2	Blanc/Noir																																																																								
Rose	<input checked="" type="checkbox"/>	3	Rose/Noir																																																																								
Bleu	<input checked="" type="checkbox"/>	4	Vert																																																																								
Orange	<input type="checkbox"/>	5	Orange/Noir																																																																								
Mauve	<input type="checkbox"/>	6	Mauve/Noir																																																																								
Jaune	<input type="checkbox"/>	7	Jaune/Noir																																																																								
Brun/Blanc	<input checked="" type="checkbox"/>																																																																										
Gris	<input checked="" type="checkbox"/>																																																																										
Gris/Noir	<input checked="" type="checkbox"/>																																																																										
Brun	<input type="checkbox"/>																																																																										

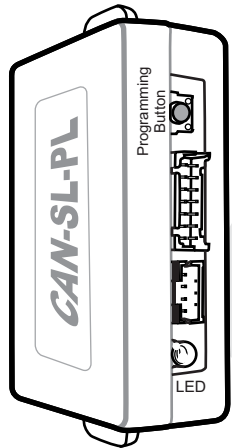

Front of the module

1

**Connecteur 1 (Noir - 4 pins):**  
Déterminez le type d'installation:

**INSTALLATION AVEC DATA-LINK**

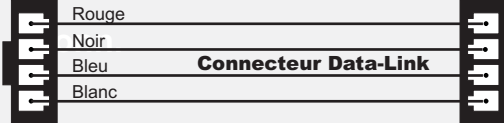

Démarrreur à distance et Alarme



**INSTALLATION SANS DATA-LINK**

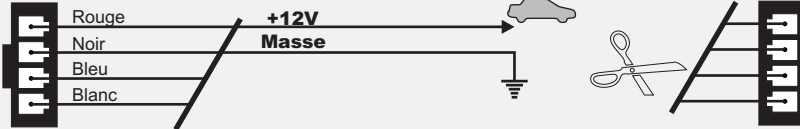

Coupez les 4 fils à l'extrémité de l'un des deux connecteurs Data-Link. Connectez le fil rouge au 12V et le fil noir à la masse du véhicule.

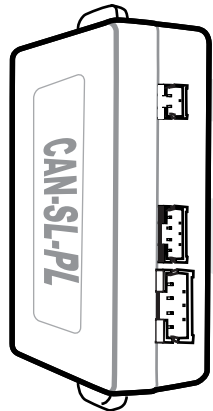

5

**Connecteur pour mise à jour par internet\***  
\*Connecteur non fournis

**Connecteur 4 (Blanc - 4 pins):**  
Connectez avec le *FLASH LINK UPDATER* pour les mises à jour par internet.

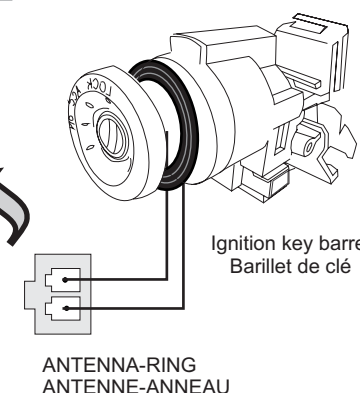

Branchement du filage au démarreur à distance/Alarme Branchement du filage au véhicule ○ SORTIE ● ENTRÉE

## CAN-SL-PL PROGRAMMING

**1** Effectuez les connexions du CAN-SL-PL au véhicule:

**1.A** **Connecteur 1 (Noir):**  
Déterminez le type d'installation (**Data-Link** ou **non Data-Link**)  
Pour l'installation DATA-LINK assurez vous de la présence du connecteur DATA-LINK sur le démarreur.  
Pour installation non Data-Link voir INSTALLATION SANS DATA-LINK.

**1.B** **Connecteur 2 (Blanc):**  
Effectuez les branchements

**1.C** **Connecteur 3 (Blanc, situé au dos du module):**  
Effectuez les branchements

**2** Maintenez le bouton de programmation enfoncé en insérant le connecteur 1 dans le CAN-SL-PL  
Le DEL s'allume pour indiquer le début de la programmation, relâchez le bouton de programmation.

**3** Branchez le connecteur 2 (CONN. 2)  
**ATTENTION: Ne pas brancher le connecteur à l'envers.**

**4** Branchez le connecteur 3 (CONN. 3)

**5** Tournez la clef en position ignition.

**6** Lorsque le DEL clignote rapidement, tournez la clef en position OFF.  
Le DEL s'éteint pour indiquer que le module est programmé.

## TBGM2 PROGRAMMING

**7** Introduisez la première clé dans le contact et tournez-la à la position ON pendant **1 secondes**.

**8** Retirez la clé.

**9** Placez le module TBGM2 prêt du devant du barillet d'ignition.

**VOUS AVEZ 5 SECONDES POUR EFFECTUER L'ÉTAPE SUIVANTE:**

**10** Démarrez le véhicule avec le démarreur à distance.  
**Le TBGM2 EST PROGRAMMÉ.**

**IMPORTANT :** Une fois le TBGM2 programmé, il ne peut être reprogrammé sur un autre véhicule.

**11**

- ▶ Retirez le capuchon du plastique du barillet d'ignition.
- ▶ Collez l'antenne (ring) autour du barillet d'ignition.
- ▶ Réinstallez le capuchon du barillet d'ignition.

**12** Branchez le module TBGM2 dans le module CAN-SL-PL en utilisant le PATS-LINK.