

# Avalon

## ADDENDUM - SUGGESTED WIRING CONFIGURATION SCHEMA DE BRANCHEMENT SUGGERÉ



**Parts required**  
1x 5A Fuse

**Pièces requises**  
1x fusible 5A

**EVO-CAN version :3.04 and newer | et plus**

Functional if equipped | Fonctionnelle si le véhicule en est équipé.

VEHICLES   VEHICULES	YEARS ANNÉES	Lock	Unlock	Arm	Disarm	Hatch (open)	Trunk (open)	Sliding Door	Window Roll Down	Gas Door	RAP Disable	Parking Lights	Memory Driver	Tachometer	Defrost	Heated Seats	Heated Mirrors	Rear Defrost	Door Status	Trunk Status	Hood Status	Hand-Brake Status	Foot-Brake Status	Transponder Bypass	PK3, Passlock	Key Control	Activate OEM Remote Start	Push-to-Start Control	SEE LEGEND
TOYOTA		A	B	C	D	E	F	G	H	I	J	K	L	M	N	O	P	Q	R	S	T	U	V	W	X	Y	Z	ZA	ZB
Avalon	Push-to-Start 2010-2011																												

**1 Driver Kick Panel  
Panneau Latéral côté chauffeur**

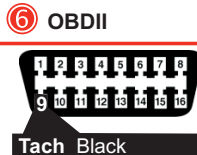

**7 PDM Fuse box  
PDM Boîte fusibles**

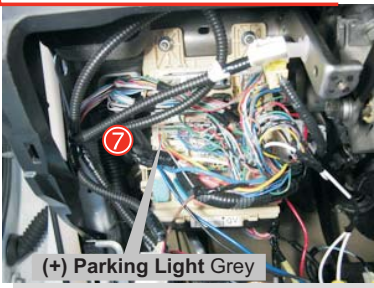

**2 3 4 5 Behind glove box  
Derrière la boîte à gant**

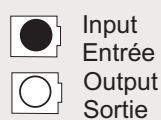
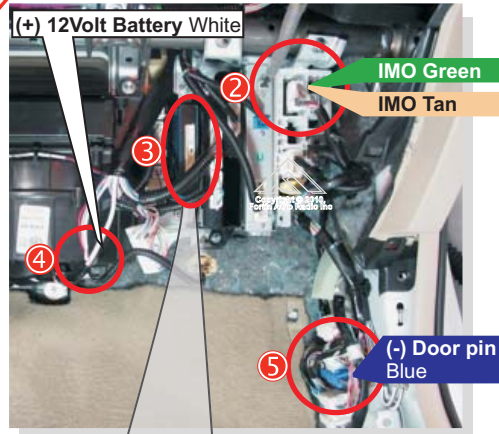

Connection always **required**  
Branchement toujours **requis**

Connection **not required** with Data-link  
Branchement **non requis** avec Data-Link

Connect to vehicle  
Branchement au véhicule

Connect to Remote-Starter/Alarm  
Branchement au démarreur à distance/Alarme

**INSTALLATION WITH DATA-LINK  
INSTALLATION AVEC DATA-LINK**

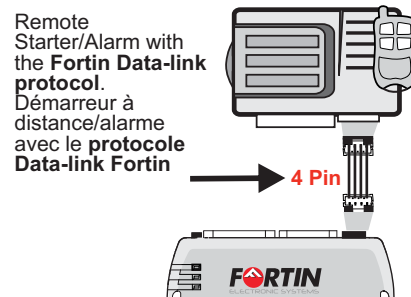

**INSTALLATION WITHOUT DATA-LINK  
INSTALLATION SANS DATA-LINK**

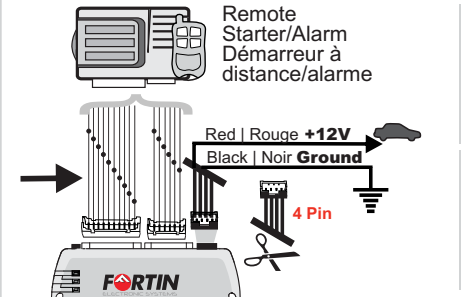





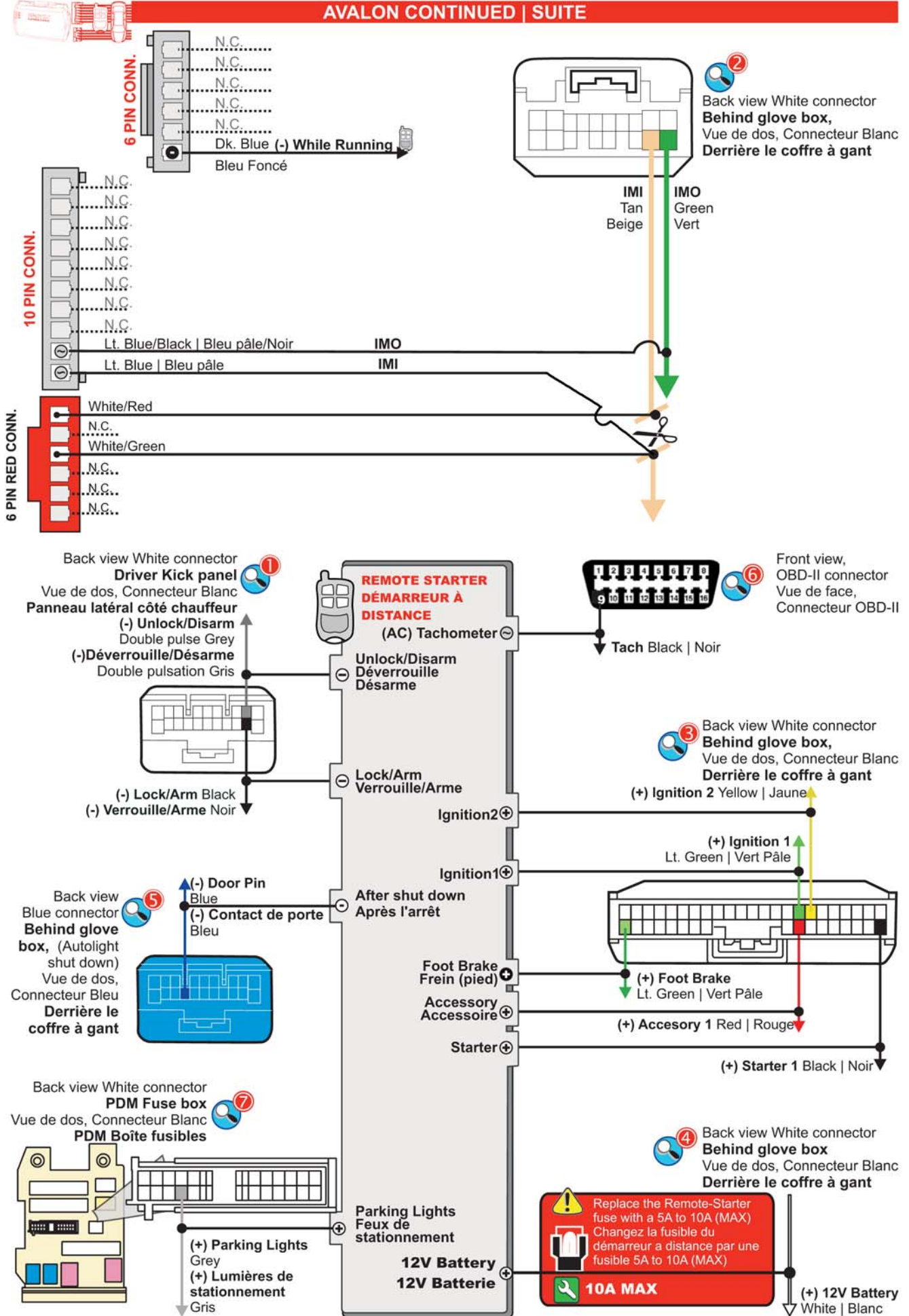

- 1 Cut off one plug of the 4 Pin Data-Link connector
- 2 Connect the Red wire to +12V
- 3 Connect the Black wire to Ground

- 1 Coupez l'extrémité du connecteur 4 pins Data-Link
- 2 Connectez le fil rouge au 12V
- 3 Connectez le fil noir à la masse du véhicule.

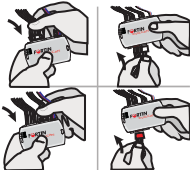
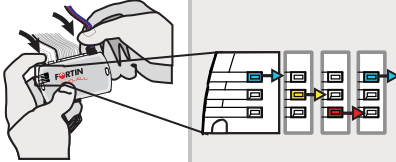
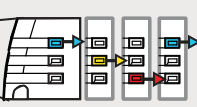
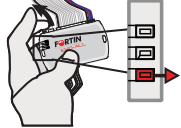

**AVALON CONTINUED | SUITE**

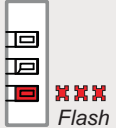
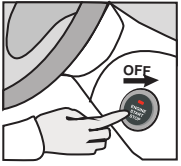
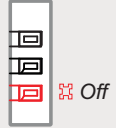

**PROGRAMMING PROCEDURE | PROCÉDURE DE PROGRAMMATION**

<p><b>1</b></p>  <p><b>Press and hold</b> the programming button:</p> <p><b>Appuyez et maintenir enfoncé</b> le bouton de programmation:</p>	<p><b>2</b></p>  <p><b>Insert</b> the remaining required connectors: 10 pin (White), 2 pin (White), 6 pin (White), 6 pin (Red), 3 pin (White).</p> <p><b>Insérez</b> les connecteurs requis restants: 10 pins (Blanc), 2 pins (Blanc), 6 pins (Blanc), 6 pins (Rouge), 3 pins (Blanc).</p>	 <p><b>Insert</b> the 4 Pin (Data-Link) connector.</p> <p><b>Insérez</b> le connecteur 4 pins (Data-Link).</p>	 <p><i>The LED will alternate between BLUE, YELLOW and RED flashes.</i></p> <p><i>Les DELS alternent entre un flash BLEU, JAUNE et ROUGE.</i></p>	 <p><b>Release</b> the programming button when the LED is <b>RED</b>.</p> <p><b>Relâchez</b> le bouton de programmation quand la DEL est <b>ROUGE</b>.</p>	 <p>If the LED is not solid RED disconnect the 4 Pin connector (Data-Link) and go back to beginning of step 1. Si le DEL n'est pas ROUGE solide débranchez le connecteur 4 pins (Data-Link) et allez au début de l'étape 1.</p>
<p><b>3</b></p>  <p><b>Press</b> on the brake pedal.</p> <p><b>Appuyer</b> sur la pédale de frein</p>	 <p><b>Press</b> the Push-to-Start button once to start the engine.</p> <p><b>Appuyez</b> 1 fois sur le bouton démarrage (Push-to-Start) pour démarrer le moteur</p>	 <p>Once the RED LED starts to flash rapidly:</p> <p><i>Lorsque le DEL ROUGE clignote rapidement:</i></p>	 <p><b>press</b> the Push-to-Start button once to shut off the ignition.</p> <p><b>appuyez</b> une fois sur le bouton démarrage (Push-to-Start) pour éteindre l'ignition.</p>	 <p>The LED will turn off.</p> <p>Le DEL s'éteint.</p>	 <p>The module is now programmed.</p> <p>Le module est programmé.</p>

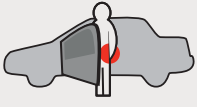
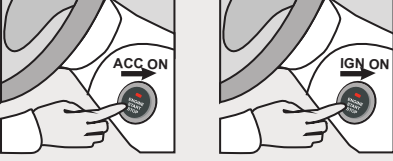
**REMOTE STARTER FUNCTIONALITY | FONCTIONNALITÉS DU DÉMARREUR À DISTANCE**

 <p><b>Remote start</b> the vehicle.</p> <p><b>Démarrez</b> à distance.</p>	 <p><b>Enter</b> the vehicle with the Intelli-Key</p> <p><b>Entrez</b> dans le véhicule avec la clé intelligente (Intelli-Key) sur vous</p>	 <p><b>Press</b> the Push-to-Start button twice to turn on the ignition.</p> <p><b>Appuyez</b> 2 fois sur le bouton démarrage (Push-to-Start) pour allumer l'ignition.</p>	 <p>The vehicle can now be put in to gear and driven.</p> <p><i>Vous êtes maintenant prêt à embrayer et prendre la route.</i></p>
--	--	--	--

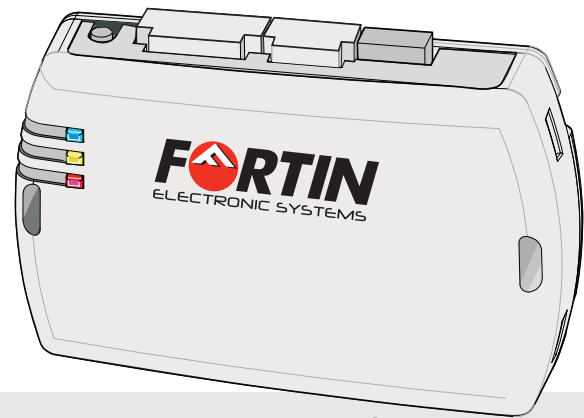

Module label | Étiquette sur le module

## **Notice:** Updated Firmware and Installation Guides

**Updated firmware and installation guides** are posted on our web site on a regular basis. We recommend that you update this module to the latest firmware and download the latest installation guide(s) prior to the installation of this product.

**Des mises à jour du Firmware (microprogramme) et des guides d'installation** sont mises en ligne régulièrement. Vérifiez que vous avez bien la dernière version logiciel et le dernier guide d'installation avant l'installation de ce produit.

## **WARNING / TECH SUPPORT / MISE EN GARDE / SUPPORT TECHNIQUE**

The information on this sheet is provided on an (as is) basis with no representation or warranty of accuracy whatsoever. It is the sole responsibility of the installer to check and verify any circuit before connecting to it. Only a computer safe logic probe or digital multimeter should be used. FORTIN ELECTRONIC SYSTEMS assumes absolutely no liability or responsibility whatsoever pertaining to the accuracy or currency of the information supplied. The installation in every case is the sole responsibility of the installer performing the work and FORTIN ELECTRONIC SYSTEMS assumes no liability or responsibility whatsoever resulting from any type of installation, whether performed properly, improperly or any other way. Neither the manufacturer or distributor of this module is responsible of damages of any kind indirectly or directly caused by this module, except for the replacement of this module in case of manufacturing defects. This module must be installed by qualified technician. The information supplied is a guide only. This instruction guide may change without notice. **Visit [www.fortinbypass.com](http://www.fortinbypass.com) to get the latest version.**

L'information de ce guide est fournie sur la base de représentation (telle quelle) sans aucune garantie de précision et d'exactitude. Il est de la seule responsabilité de l'installateur de vérifier tous les fils et circuit avant défectuer les connections. Seule une sonde logique ou un multimètre digital doivent être utilisés. FORTIN SYSTÈMES ÉLECTRONIQUES n'assume aucune responsabilité de l'exactitude de l'information fournie. L'installation (dans chaque cas) est la responsabilité de l'installateur effectuant le travail. FORTIN SYSTÈMES ÉLECTRONIQUES n'assume aucune responsabilité suite à l'installation, que celle-ci soit bonne ou mauvaise ou de n'importe autre type. Ni le fabricant, ni le distributeur ne se considèrent responsables des dommages causés ou ayant pu être causés, indirectement ou directement, par ce module, excepté le remplacement de ce module en cas de défectuosité de fabrication. Ce module doit être installé par un technicien qualifié. L'information fournie dans ce guide est une suggestion. Ce guide d'instruction peut faire l'objet de changement sans préavis. **Consultez le [www.fortinbypass.com](http://www.fortinbypass.com) pour voir la plus récente version.**

Copyright © 2006-2011, FORTIN AUTO RADIO INC ALL RIGHTS RESERVED **PATENT PENDING**



### **TECH SUPPORT**

Tél: 514-255-HELP (4357)  
1-877-336-7797



### **ADDENDUM GUIDE**

**[www.fortinbypass.com](http://www.fortinbypass.com)**  
WEB UPDATE | MISE À JOUR INTERNET

