



## ALARM AND REMOTE STARTER CAN BUS INTERFACE KIT



### WIRING / CONNECTION GUIDE

See wiring schematic configuration

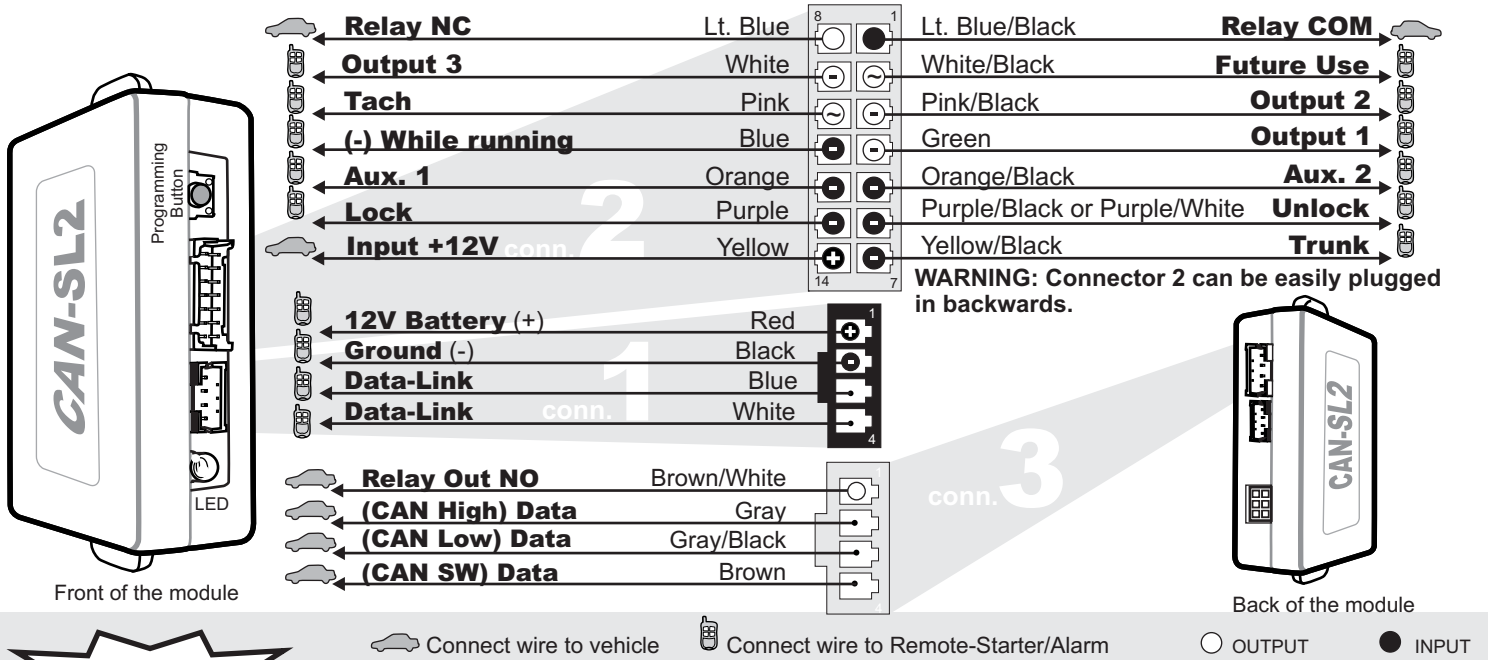

### START HERE

## INSTALLATION AND PROGRAMMING INSTRUCTIONS

- 1 Make the connections of the CAN-SL2 to the vehicle:**

  - 1.A Connector 1 (Black):**  
Determine the type of installation:  
INSTALLATION WITH DATA-LINK (See P.4)  
INSTALLATION WITHOUT DATA-LINK (See P.4)
  - 1.B Connector 2 (White):**  
Make the connections associated with the vehicle in the VEHICLE FIT GUIDE (P.2-3)
  - 1.C Connector 3 (White, located at the back of the module):**  
Make the connections associated with the vehicle in the VEHICLE FIT GUIDE (P.2-3)
- 2 Press** the programming switch while inserting the main wires harness (**CONN 1**) into the CAN-SL2 module. The LED will illuminate to indicate you are in programming mode, release the programming button.
- 3 Connect** the other connectors (**CONN. 2**)

**WARNING: Connector 2 can be easily plugged in backwards.**
- 4 Connect** the other connectors (**CONN. 3**)

- 5** Turn the key to the "ON" position.
- Once the LED starts to flash rapidly turn the key to the **OFF** position. (GMC vehicle : Start the vehicle)
- The LED will turn off to indicate the module has been programmed.

**The module is now ready for use.** (\*Chrysler, Dodge, Jeep models continue with step 7)

- \* Chrysler/Dodge/Jeep models**
- The LED will flash until you **press the OEM remote lock button.**
  - The LED will turn off to indicate the module has been programmed.

**The module is now ready for use.**

### TECHNICAL SUPPORT / INFORMATION

Neither the manufacturer or distributor of this module is responsible of damages of any kind indirectly or directly caused by this module, except for the replacement of this module in case of manufacturing defects. This module must be installed by qualified technician. This instruction guide may change without notice. Visit [www.ifar.ca](http://www.ifar.ca) to get latest version.

**Technical support:**  
TEL: 514-255-HELP (4357)  
FAX: 514-255-1367  
Web: [www.ifar.ca](http://www.ifar.ca)

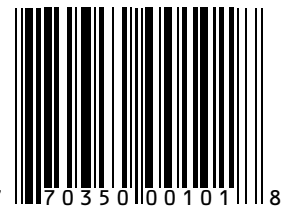



## VEHICLE FIT GUIDE / GUIDE DES VEHICULES

| Vehicles<br>Véhicules | Years<br>Années            | Fonctionnel if equipped   Fonctionnelle si le véhicule en est équipé. |                          |                            |                       |                 |      |                                 |                              |   |  |  |                           |                   |                      |                           |                             |                      |                           |                            |                   | CAN High<br>CAN Haute | CAN Low<br>CAN Basse | CAN SW<br>CAN SW                             |  |
|-----------------------|----------------------------|---|--------------------------|----------------------------|-----------------------|-----------------|------|---------------------------------|------------------------------|---|--|--|---------------------------|-------------------|----------------------|---------------------------|-----------------------------|----------------------|---------------------------|----------------------------|-------------------|-----------------------|----------------------|--|--|
|                       |                            | Verrouillage<br>Lock  | Déverrouillage<br>Unlock | Aménagement<br>Accessories | Désarmement<br>Disarm | Trunk<br>Valise | Tech | Start alarm<br>Alerte démarrage | Start enable<br>Autorisation | Door trigger<br>Déclenchement de la porte | Trunk trigger<br>Déclenchement du coffre | Hood trigger<br>Déclenchement du capot | Radio Off<br>Radio éteint | Trampon<br>Pédale | Pas de clé<br>No key | Pompe à eau<br>Water pump | Stabilisateur<br>Stabilizer | Déclatage<br>Popcorn | Sécheresse<br>Heat sensor | Heat sensor<br>Température | Carillon<br>Chime |                       |                      |  | Gas foot<br>Pédale à gaz                     |
| <b>Acura</b>          | 02 03 04 05 06 07 08 09 10 | A   | B                        | C                          | D                     | E               | F    | G                               | H                            | I   | J  | K                                      | L                         | M                 | N                    | O                         | P                           | Q                    | R                         | S                          | T                 | 3                     |                      | CAN SW: Green                                |  |
| MDX                   |                            |   |                          |                            |                       |                 |      |                                 |                              |   |  |  |                           |                   |                      |                           |                             |                      |                           |                            |                   |                       | 3                    |  | CAN SW: Lt. Green Pin#5 (Connector 21 Pin)   |
| RL                    |                            |   |                          |                            |                       |                 |      |                                 |                              |   |  |  |                           |                   |                      |                           |                             |                      |                           |                            |                   |                       | 1                    |  | CAN SW: Brown/Black                          |
| TL                    |                            |   |                          |                            |                       |                 |      |                                 |                              |   |  |  |                           |                   |                      |                           |                             |                      |                           |                            |                   |                       | 1                    |  | CAN SW: Brown/Black                          |
| TSX                   |                            |   |                          |                            |                       |                 |      |                                 |                              |   |  |  |                           |                   |                      |                           |                             |                      |                           |                            |                   |                       | 17                   |  | CAN High: Pink CAN Low: Blue                 |
| <b>Audi</b>           | 02 03 04 05 06 07 08 09 10 | A   | B                        | C                          | D                     | E               | F    | G                               | H                            | I   | J  | K                                      | L                         | M                 | N                    | O                         | P                           | Q                    | R                         | S                          | T                 | 4                     |                      | CAN High: Orange/Green CAN Low: Orange/Brown |  |
| A3                    |                            |   |                          |                            |                       |                 |      |                                 |                              |   |  |  |                           |                   |                      |                           |                             |                      |                           |                            |                   |                       | 6                    |  | CAN High: Orange/Green CAN Low: Orange/Brown |
| A4                    |                            |   |                          |                            |                       |                 |      |                                 |                              |   |  |  |                           |                   |                      |                           |                             |                      |                           |                            |                   |                       | 4                    |  | CAN High: Orange/Green CAN Low: Orange/Brown |
| A6                    |                            |   |                          |                            |                       |                 |      |                                 |                              |   |  |  |                           |                   |                      |                           |                             |                      |                           |                            |                   |                       | 6                    |  | CAN High: Orange/Green CAN Low: Orange/Brown |
| A8                    |                            |   |                          |                            |                       |                 |      |                                 |                              |   |  |  |                           |                   |                      |                           |                             |                      |                           |                            |                   |                       | 6                    |  | CAN High: Orange/Green CAN Low: Orange/Brown |
| Allroad               |                            |   |                          |                            |                       |                 |      |                                 |                              |   |  |  |                           |                   |                      |                           |                             |                      |                           |                            |                   |                       | 4                    |  | CAN High: Orange/Green CAN Low: Orange/Brown |
| Q7                    |                            |   |                          |                            |                       |                 |      |                                 |                              |   |  |  |                           |                   |                      |                           |                             |                      |                           |                            |                   |                       | 6                    |  | CAN High: Orange/Green CAN Low: Orange/Brown |
| S4                    |                            |   |                          |                            |                       |                 |      |                                 |                              |   |  |  |                           |                   |                      |                           |                             |                      |                           |                            |                   |                       | 11                   |  | CAN High: Orange/Green CAN Low: Green        |
| <b>BMW</b>            | 02 03 04 05 06 07 08 09 10 | A   | B                        | C                          | D                     | E               | F    | G                               | H                            | I   | J  | K                                      | L                         | M                 | N                    | O                         | P                           | Q                    | R                         | S                          | T                 | 11                    |                      | CAN High: Black CAN Low: Yellow              |  |
| 3 Series              |                            |   |                          |                            |                       |                 |      |                                 |                              |   |  |  |                           |                   |                      |                           |                             |                      |                           |                            |                   |                       | 11                   |  | CAN High: Orange/Green CAN Low: Green        |
| 5 Series              |                            |   |                          |                            |                       |                 |      |                                 |                              |   |  |  |                           |                   |                      |                           |                             |                      |                           |                            |                   |                       | 11                   |  | CAN High: Black CAN Low: Yellow              |
| X5                    |                            |   |                          |                            |                       |                 |      |                                 |                              |   |  |  |                           |                   |                      |                           |                             |                      |                           |                            |                   |                       | 11                   |  | CAN High: Orange/Green CAN Low: Green        |
| <b>Buick</b>          | 02 03 04 05 06 07 08 09 10 | A   | B                        | C                          | D                     | E               | F    | G                               | H                            | I   | J  | K                                      | L                         | M                 | N                    | O                         | P                           | Q                    | R                         | S                          | T                 | 16                    |                      | CAN SW: Green                                |  |
| Enclave               |                            |   |                          |                            |                       |                 |      |                                 |                              |   |  |  |                           |                   |                      |                           |                             |                      |                           |                            |                   |                       | 16                   |  | CAN SW: Green                                |
| Lucerne               |                            |   |                          |                            |                       |                 |      |                                 |                              |   |  |  |                           |                   |                      |                           |                             |                      |                           |                            |                   |                       | 16                   |  | CAN SW: Green                                |
| <b>Cadillac</b>       | 02 03 04 05 06 07 08 09 10 | A   | B                        | C                          | D                     | E               | F    | G                               | H                            | I   | J  | K                                      | L                         | M                 | N                    | O                         | P                           | Q                    | R                         | S                          | T                 | 16                    |                      | CAN SW: Green                                |  |
| CTS                   |                            |   |                          |                            |                       |                 |      |                                 |                              |   |  |  |                           |                   |                      |                           |                             |                      |                           |                            |                   |                       | 16                   |  | CAN SW: Green                                |
| DTS                   |                            |   |                          |                            |                       |                 |      |                                 |                              |   |  |  |                           |                   |                      |                           |                             |                      |                           |                            |                   |                       | 16                   |  | CAN SW: Green                                |
| Escalade              |                            |   |                          |                            |                       |                 |      |                                 |                              |   |  |  |                           |                   |                      |                           |                             |                      |                           |                            |                   |                       | 16                   |  | CAN SW: Green                                |
| SRX                   |                            |   |                          |                            |                       |                 |      |                                 |                              |   |  |  |                           |                   |                      |                           |                             |                      |                           |                            |                   |                       | 16                   |  | CAN SW: Green                                |
| STS                   |                            |   |                          |                            |                       |                 |      |                                 |                              |   |  |  |                           |                   |                      |                           |                             |                      |                           |                            |                   |                       | 16                   |  | CAN SW: Green                                |
| <b>Chevrolet</b>      | 02 03 04 05 06 07 08 09 10 | A   | B                        | C                          | D                     | E               | F    | G                               | H                            | I   | J  | K                                      | L                         | M                 | N                    | O                         | P                           | Q                    | R                         | S                          | T                 | 16                    |                      | CAN SW: Green                                |  |
| Avalanche             |                            |   |                          |                            |                       |                 |      |                                 |                              |   |  |  |                           |                   |                      |                           |                             |                      |                           |                            |                   |                       | 16                   |  | CAN SW: Green                                |
| CK Pickup             |                            |   |                          |                            |                       |                 |      |                                 |                              |   |  |  |                           |                   |                      |                           |                             |                      |                           |                            |                   |                       | 15                   |  | CAN SW: Green Data Keyless: Tan/White        |
| Cobalt                |                            |   |                          |                            |                       |                 |      |                                 |                              |   |  |  |                           |                   |                      |                           |                             |                      |                           |                            |                   |                       | 16                   |  | CAN SW: Green                                |
| Equinox               |                            |   |                          |                            |                       |                 |      |                                 |                              |   |  |  |                           |                   |                      |                           |                             |                      |                           |                            |                   |                       | 16                   |  | CAN SW: Green                                |
| Express               |                            |   |                          |                            |                       |                 |      |                                 |                              |   |  |  |                           |                   |                      |                           |                             |                      |                           |                            |                   |                       | 15                   |  | CAN SW: Green Data Keyless: Tan/White        |
| HHR                   |                            |   |                          |                            |                       |                 |      |                                 |                              |   |  |  |                           |                   |                      |                           |                             |                      |                           |                            |                   |                       | 16                   |  | CAN SW: Green                                |
| Impala                |                            |   |                          |                            |                       |                 |      |                                 |                              |   |  |  |                           |                   |                      |                           |                             |                      |                           |                            |                   |                       | 15                   |  | CAN SW: Green Data Keyless: Lt. Green        |
| Malibu                |                            |   |                          |                            |                       |                 |      |                                 |                              |   |  |  |                           |                   |                      |                           |                             |                      |                           |                            |                   |                       | 16                   |  | CAN SW: Green                                |
| Monte Carlo           |                            |   |                          |                            |                       |                 |      |                                 |                              |   |  |  |                           |                   |                      |                           |                             |                      |                           |                            |                   |                       | 16                   |  | CAN SW: Green                                |
| Silverado             |                            |   |                          |                            |                       |                 |      |                                 |                              |   |  |  |                           |                   |                      |                           |                             |                      |                           |                            |                   |                       | 16                   |  | CAN SW: Green                                |
| Suburban              |                            |   |                          |                            |                       |                 |      |                                 |                              |   |  |  |                           |                   |                      |                           |                             |                      |                           |                            |                   |                       | 16                   |  | CAN SW: Green                                |
| Tahoe                 |                            |   |                          |                            |                       |                 |      |                                 |                              |   |  |  |                           |                   |                      |                           |                             |                      |                           |                            |                   |                       | 16                   |  | CAN SW: Green                                |
| <b>Chrysler</b>       | 02 03 04 05 06 07 08 09 10 | A   | B                        | C                          | D                     | E               | F    | G                               | H                            | I   | J  | K                                      | L                         | M                 | N                    | O                         | P                           | Q                    | R                         | S                          | T                 | 5                     |                      | CAN High: White/Orange CAN Low: White        |  |
| Aspen                 |                            |   |                          |                            |                       |                 |      |                                 |                              |   |  |  |                           |                   |                      |                           |                             |                      |                           |                            |                   |                       | 5                    |  | CAN High: White/Green CAN Low: White/Blue    |
| Crossfire             |                            |   |                          |                            |                       |                 |      |                                 |                              |   |  |  |                           |                   |                      |                           |                             |                      |                           |                            |                   |                       | 5                    |  | CAN High: White/Orange CAN Low: White/Pink   |
| Sebrina               |                            |   |                          |                            |                       |                 |      |                                 |                              |   |  |  |                           |                   |                      |                           |                             |                      |                           |                            |                   |                       | 5                    |  | CAN High: White/Blue CAN Low: White/Brown    |
| Town and Country      |                            |   |                          |                            |                       |                 |      |                                 |                              |   |  |  |                           |                   |                      |                           |                             |                      |                           |                            |                   |                       | 5                    |  | CAN High: White/Orange CAN Low: White        |
| 300                   |                            |   |                          |                            |                       |                 |      |                                 |                              |   |  |  |                           |                   |                      |                           |                             |                      |                           |                            |                   |                       | 5                    |  | CAN High: White/Orange CAN Low: White        |
| 300C                  |                            |   |                          |                            |                       |                 |      |                                 |                              |   |  |  |                           |                   |                      |                           |                             |                      |                           |                            |                   |                       | 5                    |  | CAN High: White/Orange CAN Low: White        |
| <b>Dodge</b>          | 02 03 04 05 06 07 08 09 10 | A   | B                        | C                          | D                     | E               | F    | G                               | H                            | I   | J  | K                                      | L                         | M                 | N                    | O                         | P                           | Q                    | R                         | S                          | T                 | 5                     |                      | CAN High: White/Orange CAN Low: White/Pink   |  |
| Avenger               |                            |   |                          |                            |                       |                 |      |                                 |                              |   |  |  |                           |                   |                      |                           |                             |                      |                           |                            |                   |                       | 5                    |  | CAN High: White/Orange CAN Low: White/Pink   |
| Caliber               |                            |   |                          |                            |                       |                 |      |                                 |                              |   |  |  |                           |                   |                      |                           |                             |                      |                           |                            |                   |                       | 5                    |  | CAN High: White/Blue CAN Low: White/Brown    |
| Caravan               |                            |   |                          |                            |                       |                 |      |                                 |                              |   |  |  |                           |                   |                      |                           |                             |                      |                           |                            |                   |                       | 5                    |  | CAN High: White/Orange CAN Low: White        |
| Charger               |                            |   |                          |                            |                       |                 |      |                                 |                              |   |  |  |                           |                   |                      |                           |                             |                      |                           |                            |                   |                       | 5                    |  | CAN High: White/Orange CAN Low: White        |
| Dakota                |                            |   |                          |                            |                       |                 |      |                                 |                              |   |  |  |                           |                   |                      |                           |                             |                      |                           |                            |                   |                       | 5                    |  | CAN High: White/Orange CAN Low: White        |
| Durango               |                            |   |                          |                            |                       |                 |      |                                 |                              |   |  |  |                           |                   |                      |                           |                             |                      |                           |                            |                   |                       | 5                    |  | CAN High: White/Orange CAN Low: White        |
| Journey               |                            |   |                          |                            |                       |                 |      |                                 |                              |   |  |  |                           |                   |                      |                           |                             |                      |                           |                            |                   |                       | 5                    |  | CAN High: White/Green CAN Low: White/Blue    |
| Magnum                |                            |   |                          |                            |                       |                 |      |                                 |                              |   |  |  |                           |                   |                      |                           |                             |                      |                           |                            |                   |                       | 5                    |  | CAN High: White/Orange CAN Low: White        |
| Nitro                 |                            |   |                          |                            |                       |                 |      |                                 |                              |   |  |  |                           |                   |                      |                           |                             |                      |                           |                            |                   |                       | 5                    |  | CAN High: White/Green CAN Low: White/Blue    |
| Ram                   |                            |   |                          |                            |                       |                 |      |                                 |                              |   |  |  |                           |                   |                      |                           |                             |                      |                           |                            |                   |                       | 5                    |  | CAN High: White/Orange CAN Low: White        |
| Sprinter              |                            |   |                          |                            |                       |                 |      |                                 |                              |   |  |  |                           |                   |                      |                           |                             |                      |                           |                            |                   |                       | 5                    |  | CAN High: Brown/Red CAN Low: Brown           |
| <b>GMC</b>            | 02 03 04 05 06 07 08 09 10 | A   | B                        | C                          | D                     | E               | F    | G                               | H                            | I   | J  | K                                      | L                         | M                 | N                    | O                         | P                           | Q                    | R                         | S                          | T                 | 16                    |                      | CAN SW: Green                                |  |
| Acadia                |                            |   |                          |                            |                       |                 |      |                                 |                              |   |  |  |                           |                   |                      |                           |                             |                      |                           |                            |                   |                       | 16                   |  | CAN SW: Green                                |
| Savana                |                            |   |                          |                            |                       |                 |      |                                 |                              |   |  |  |                           |                   |                      |                           |                             |                      |                           |                            |                   |                       | 16                   |  | CAN SW: Green                                |
| Sierra                |                            |   |                          |                            |                       |                 |      |                                 |                              |   |  |  |                           |                   |                      |                           |                             |                      |                           |                            |                   |                       | 16                   |  | CAN SW: Green                                |
| Suburban              |                            |   |                          |                            |                       |                 |      |                                 |                              |   |  |  |                           |                   |                      |                           |                             |                      |                           |                            |                   |                       | 16                   |  | CAN SW: Green                                |
| Yukon                 |                            |   |                          |                            |                       |                 |      |                                 |                              |   |  |  |                           |                   |                      |                           |                             |                      |                           |                            |                   |                       | 16                   |  | CAN SW: Green                                |
| <b>Honda</b>          | 02 03 04 05 06 07 08 09 10 | A   | B                        | C                          | D                     | E               | F    | G                               | H                            | I   | J  | K                                      | L                         | M                 | N                    | O                         | P                           | Q                    | R                         | S                          | T                 | 1                     |                      | CAN SW: Brown/Red                            |  |
| Accord                |                            |   |                          |                            |                       |                 |      |                                 |                              |   |  |  |                           |                   |                      |                           |                             |                      |                           |                            |                   |                       | 17                   |  | CAN High: Pink CAN Low: Blue                 |
| Accord Hybrid         |                            |   |                          |                            |                       |                 |      |                                 |                              |   |  |  |                           |                   |                      |                           |                             |                      |                           |                            |                   |                       | 1                    |  | CAN SW: Brown/Red                            |
| Odyssey               |                            |   |                          |                            |                       |                 |      |                                 |                              |   |  |  |                           |                   |                      |                           |                             |                      |                           |                            |                   |                       | 3                    |  | CAN SW: Green/Red                            |
| Pilot                 |                            |   |                          |                            |                       |                 |      |                                 |                              |   |  |  |                           |                   |                      |                           |                             |                      |                           |                            |                   |                       | 17                   |  | CAN High: White CAN Low: Green               |
| Ridgeline             |                            |   |                          |                            |                       |                 |      |                                 |                              |   |  |  |                           |                   |                      |                           |                             |                      |                           |                            |                   |                       | 1                    |  | CAN SW: Brown/Black                          |
| <b>Hummer</b>         | 02 03 04 05 06 07 08 09 10 | A   | B                        | C                          | D                     | E               | F    | G                               | H                            | I   | J  | K                                      | L                         | M                 | N                    | O                         | P                           | Q                    | R                         | S                          | T                 | 16                    |                      | CAN High: Blue/Black CAN Low: Green/Black    |  |
| H2                    |                            |   |                          |                            |                       |                 |      |                                 |                              |   |  |  |                           |                   |                      |                           |                             |                      |                           |                            |                   |                       | 10                   |  | CAN High: Blue/Black CAN Low: Green/Black    |
| <b>Hyundai</b>        | 02 03 04 05 06 07 08 09 10 | A   | B                        | C                          | D                     | E               | F    | G                               | H                            | I   | J  | K                                      | L                         | M                 | N                    | O                         | P                           | Q                    | R                         | S                          | T                 | 9                     |                      | CAN High: Black CAN Low: White               |  |
| Azera                 |                            |   |                          |                            |                       |                 |      |                                 |                              |   |  |  |                           |                   |                      |                           |                             |                      |                           |                            |                   |                       | 10                   |  | CAN High: Red/Black CAN Low: Blue            |
| Entourage             |                            |   |                          |                            |                       |                 |      |                                 |                              |   |  |  |                           |                   |                      |                           |                             |                      |                           |                            |                   |                       | 10                   |  | CAN High: Red/Black CAN Low: Blue            |
| Veracruz              |                            |   |                          |                            |                       |                 |      |                                 |                              |   |  |  |                           |                   |                      |                           |                             |                      |                           |                            |                   |                       | 13                   |  | CAN High: Blue CAN Low: Pink or Yellow       |
| <b>Infiniti</b>       | 02 03 04 05 06 07 08 09 10 | A   | B                        | C                          | D                     | E               | F    | G                               | H                            | I   | J  | K                                      | L                         | M                 | N                    | O                         | P                           | Q                    | R                         | S                          | T                 | 13                    |                      | CAN High: Blue CAN Low: Pink or Yellow       |  |
| EX35                  |                            |   |                          |                            |                       |                 |      |                                 |                              |   |  |  |                           |                   |                      |                           |                             |                      |                           |                            |                   |                       | 13                   |  | CAN High: Blue CAN Low: Pink or Yellow       |
| FX35, FX45            |                            |   |                          |                            |                       |                 |      |                                 |                              |   |  |  |                           |                   |                      |                           |                             |                      |                           |                            |                   |                       | 13                   |  | CAN High: Blue CAN Low: Pink or Yellow       |
| FX35, FX45 1.K*       |                            |   |                          |                            |                       |                 |      |                                 |                              |   |  |  |                           |                   |                      |                           |                             |                      |                           |                            |                   |                       | 13                   |  | CAN High: Blue CAN Low: Pink or Yellow       |
| G35                   |                            |   |                          |                            |                       |                 |      |                                 |                              |   |  |  |                           |                   |                      |                           |                             |                      |                           |                            |                   |                       | 13                   |  | CAN High: Blue CAN Low: Pink or Yellow       |
| G35 Intel. Key        |                            |   |                          |                            |                       |                 |      |                                 |                              |   |  |  |                           |                   |                      |                           |                             |                      |                           |                            |                   |                       | 13                   |  | CAN High: Blue CAN Low: Pink or Yellow       |
| G37                   |                            |   |                          |                            |                       |                 |      |                                 |                              |   |  |  |                           |                   |                      |                           |                             |                      |                           |                            |                   |                       | 13                   |  | CAN High: Blue CAN Low: Pink or Yellow       |
| M35, M4               |                            |   |                          |                            |                       |                 |      |                                 |                              |   |  |  |                           |                   |                      |                           |                             |                      |                           |                            |                   |                       |                      |  |  |



## VEHICLE FIT GUIDE / GUIDE DES VÉHICULES

| Vehicles<br>Véhicules | Years<br>Années |    |    |    |    |    |    |    |    | Fonctionnel if equipped / Fonctionnelle si le véhicule en est équipé. |   |   |   |   |   |   |   |   |   |   |   |   |   |   |   |   | Config.<br>Schéma de câblage | Schematic<br>Schéma de câblage | Vehicles Data<br>Véhicules Données de la couleur de la peinture de l'année |   |       |  |
|-----------------------|-----------------|----|----|----|----|----|----|----|----|---|---|---|---|---|---|---|---|---|---|---|---|---|---|---|---|---|------------------------------|--------------------------------|--|---|-------|--|
|                       | 01              | 02 | 03 | 04 | 05 | 06 | 07 | 08 | 09 | 10  | A | B | C | D | E | F | G | H | I | J | K | L | M | N | O | P |                              |                                |  | Q | R     | S  |
| <b>Jeep</b>           |                 |    |    |    |    |    |    |    |    |   |   |   |   |   |   |   |   |   |   |   |   |   |   |   |   |   |                              |                                |  |   | U     |  |
| Cherokee              |                 |    |    |    |    |    |    |    |    |   |   |   |   |   |   |   |   |   |   |   |   |   |   |   |   |   |                              |                                |  |   | 5     | CAN High: White/Orange CAN Low: White  |
| Commander             |                 |    |    |    |    |    |    |    |    |   |   |   |   |   |   |   |   |   |   |   |   |   |   |   |   |   |                              |                                |  |   | 5     | CAN High: White/Orange CAN Low: White  |
| Compass               |                 |    |    |    |    |    |    |    |    |   |   |   |   |   |   |   |   |   |   |   |   |   |   |   |   |   |                              |                                |  |   | 5     | CAN High: White/Orange CAN Low: White/Pink   |
| Grand Cherokee        |                 |    |    |    |    |    |    |    |    |   |   |   |   |   |   |   |   |   |   |   |   |   |   |   |   |   |                              |                                |  |   | 5     | CAN High: White/Orange CAN Low: White  |
| Patriot               |                 |    |    |    |    |    |    |    |    |   |   |   |   |   |   |   |   |   |   |   |   |   |   |   |   |   |                              |                                |  |   | 5     | CAN High: White/Orange CAN Low: White/Pink   |
| Liberty               |                 |    |    |    |    |    |    |    |    |   |   |   |   |   |   |   |   |   |   |   |   |   |   |   |   |   |                              |                                |  |   | 5     | CAN High: White/Green CAN Low: White/Blue  |
| Wrangler              |                 |    |    |    |    |    |    |    |    |   |   |   |   |   |   |   |   |   |   |   |   |   |   |   |   |   |                              |                                |  |   | 5     | CAN High: White/Green CAN Low: White/Blue  |
| <b>Kia</b>            |                 |    |    |    |    |    |    |    |    |   |   |   |   |   |   |   |   |   |   |   |   |   |   |   |   |   |                              |                                |  |   | U     |  |
| Amanti                |                 |    |    |    |    |    |    |    |    |   |   |   |   |   |   |   |   |   |   |   |   |   |   |   |   |   |                              |                                |  |   | 10    | CAN High: Brown CAN Low: White   |
| Sedona                |                 |    |    |    |    |    |    |    |    |   |   |   |   |   |   |   |   |   |   |   |   |   |   |   |   |   |                              |                                |  |   | 9     | CAN High: Red or Black CAN Low: White  |
| <b>Land Rover</b>     |                 |    |    |    |    |    |    |    |    |   |   |   |   |   |   |   |   |   |   |   |   |   |   |   |   |   |                              |                                |  |   | U     |  |
| Freelander            |                 |    |    |    |    |    |    |    |    |   |   |   |   |   |   |   |   |   |   |   |   |   |   |   |   |   |                              |                                |  |   | ***** |  |
| <b>Lincoln</b>        |                 |    |    |    |    |    |    |    |    |   |   |   |   |   |   |   |   |   |   |   |   |   |   |   |   |   |                              |                                |  |   | U     |  |
| MKZ                   |                 |    |    |    |    |    |    |    |    |   |   |   |   |   |   |   |   |   |   |   |   |   |   |   |   |   |                              |                                |  |   | 14    | CAN High: Gray/Orange CAN Low: Purple/Orange   |
| <b>Mercedes</b>       |                 |    |    |    |    |    |    |    |    |   |   |   |   |   |   |   |   |   |   |   |   |   |   |   |   |   |                              |                                |  |   | U     |  |
| C230                  |                 |    |    |    |    |    |    |    |    |   |   |   |   |   |   |   |   |   |   |   |   |   |   |   |   |   |                              |                                |  |   | 6     | CAN High: Brown/Red CAN Low: Brown   |
| C32                   |                 |    |    |    |    |    |    |    |    |   |   |   |   |   |   |   |   |   |   |   |   |   |   |   |   |   |                              |                                |  |   | 6     | CAN High: Brown/Red CAN Low: Brown   |
| SLK 280               |                 |    |    |    |    |    |    |    |    |   |   |   |   |   |   |   |   |   |   |   |   |   |   |   |   |   |                              |                                |  |   | 7     | CAN High: Brown/Red CAN Low: Brown   |
| <b>Mitsubishi</b>     |                 |    |    |    |    |    |    |    |    |   |   |   |   |   |   |   |   |   |   |   |   |   |   |   |   |   |                              |                                |  |   | U     |  |
| Outlander             |                 |    |    |    |    |    |    |    |    |   |   |   |   |   |   |   |   |   |   |   |   |   |   |   |   |   |                              |                                |  |   | 18    | CAN High: Yellow CAN Low: Lt. Green  |
| Lancer                |                 |    |    |    |    |    |    |    |    |   |   |   |   |   |   |   |   |   |   |   |   |   |   |   |   |   |                              |                                |  |   | 18    | CAN High: Yellow CAN Low: Lt. Green  |
| <b>Nissan</b>         |                 |    |    |    |    |    |    |    |    |   |   |   |   |   |   |   |   |   |   |   |   |   |   |   |   |   |                              |                                |  |   | U     |  |
| Altima                |                 |    |    |    |    |    |    |    |    |   |   |   |   |   |   |   |   |   |   |   |   |   |   |   |   |   |                              |                                |  |   | 13    | CAN High: Blue CAN Low: Pink or Yellow   |
| Armada                |                 |    |    |    |    |    |    |    |    |   |   |   |   |   |   |   |   |   |   |   |   |   |   |   |   |   |                              |                                |  |   | 13    | See www.ifar.ca for installation schematic / Voir www.ifar.ca pour les schéma d'installation |
| Frontier              |                 |    |    |    |    |    |    |    |    |   |   |   |   |   |   |   |   |   |   |   |   |   |   |   |   |   |                              |                                |  |   | 13    | CAN High: Blue CAN Low: Pink or Yellow   |
| Maxima                |                 |    |    |    |    |    |    |    |    |   |   |   |   |   |   |   |   |   |   |   |   |   |   |   |   |   |                              |                                |  |   | 13    | CAN High: Blue CAN Low: Pink or Yellow   |
| Maxima Intel. Key     |                 |    |    |    |    |    |    |    |    |   |   |   |   |   |   |   |   |   |   |   |   |   |   |   |   |   |                              |                                |  |   | 13    | CAN High: Blue CAN Low: Pink or Yellow   |
| Murano                |                 |    |    |    |    |    |    |    |    |   |   |   |   |   |   |   |   |   |   |   |   |   |   |   |   |   |                              |                                |  |   | 13    | CAN High: Blue CAN Low: Pink or Yellow   |
| Murano Intel. Key     |                 |    |    |    |    |    |    |    |    |   |   |   |   |   |   |   |   |   |   |   |   |   |   |   |   |   |                              |                                |  |   | 13    | See www.ifar.ca for installation schematic / Voir www.ifar.ca pour les schéma d'installation |
| Pathfinder            |                 |    |    |    |    |    |    |    |    |   |   |   |   |   |   |   |   |   |   |   |   |   |   |   |   |   |                              |                                |  |   | 13    | CAN High: Blue CAN Low: Pink or Yellow   |
| Quest                 |                 |    |    |    |    |    |    |    |    |   |   |   |   |   |   |   |   |   |   |   |   |   |   |   |   |   |                              |                                |  |   | 13    | CAN High: Blue CAN Low: Pink or Yellow   |
| Rogue                 |                 |    |    |    |    |    |    |    |    |   |   |   |   |   |   |   |   |   |   |   |   |   |   |   |   |   |                              |                                |  |   | 13    | CAN High: Blue CAN Low: Pink or Yellow   |
| Sentra                |                 |    |    |    |    |    |    |    |    |   |   |   |   |   |   |   |   |   |   |   |   |   |   |   |   |   |                              |                                |  |   | 13    | CAN High: Blue CAN Low: Pink or Yellow   |
| Titan                 |                 |    |    |    |    |    |    |    |    |   |   |   |   |   |   |   |   |   |   |   |   |   |   |   |   |   |                              |                                |  |   | 13    | CAN High: Blue CAN Low: Pink or Yellow   |
| Versa                 |                 |    |    |    |    |    |    |    |    |   |   |   |   |   |   |   |   |   |   |   |   |   |   |   |   |   |                              |                                |  |   | 13    | CAN High: Blue CAN Low: Pink or Yellow   |
| Xterra                |                 |    |    |    |    |    |    |    |    |   |   |   |   |   |   |   |   |   |   |   |   |   |   |   |   |   |                              |                                |  |   | 13    | CAN High: Blue CAN Low: Pink or Yellow   |
| 350Z                  |                 |    |    |    |    |    |    |    |    |   |   |   |   |   |   |   |   |   |   |   |   |   |   |   |   |   |                              |                                |  |   | 13    | CAN High: Blue CAN Low: Pink or Yellow   |
| <b>Pontiac</b>        |                 |    |    |    |    |    |    |    |    |   |   |   |   |   |   |   |   |   |   |   |   |   |   |   |   |   |                              |                                |  |   | U     |  |
| Pursuit               |                 |    |    |    |    |    |    |    |    |   |   |   |   |   |   |   |   |   |   |   |   |   |   |   |   |   |                              |                                |  |   | 15    | CAN SW: Green Data Keyless: Tan/White  |
| G5                    |                 |    |    |    |    |    |    |    |    |   |   |   |   |   |   |   |   |   |   |   |   |   |   |   |   |   |                              |                                |  |   | 15    | CAN SW: Green Data Keyless: Tan/White  |
| G6                    |                 |    |    |    |    |    |    |    |    |   |   |   |   |   |   |   |   |   |   |   |   |   |   |   |   |   |                              |                                |  |   | 15    | CAN SW: Green Data Keyless: Lt. Green  |
| G8                    |                 |    |    |    |    |    |    |    |    |   |   |   |   |   |   |   |   |   |   |   |   |   |   |   |   |   |                              |                                |  |   | 16    | CAN SW: Green  |
| Solstice              |                 |    |    |    |    |    |    |    |    |   |   |   |   |   |   |   |   |   |   |   |   |   |   |   |   |   |                              |                                |  |   | 15    | CAN SW: Green Data Keyless: Tan/White  |
| Torrent               |                 |    |    |    |    |    |    |    |    |   |   |   |   |   |   |   |   |   |   |   |   |   |   |   |   |   |                              |                                |  |   | 16    | CAN SW: Green  |
| <b>Porsche</b>        |                 |    |    |    |    |    |    |    |    |   |   |   |   |   |   |   |   |   |   |   |   |   |   |   |   |   |                              |                                |  |   | U     |  |
| Cayenne               |                 |    |    |    |    |    |    |    |    |   |   |   |   |   |   |   |   |   |   |   |   |   |   |   |   |   |                              |                                |  |   | 6     | CAN High: Orange/Green CAN Low: Orange/Brown   |
| <b>Saturn</b>         |                 |    |    |    |    |    |    |    |    |   |   |   |   |   |   |   |   |   |   |   |   |   |   |   |   |   |                              |                                |  |   | U     |  |
| Astra                 |                 |    |    |    |    |    |    |    |    |   |   |   |   |   |   |   |   |   |   |   |   |   |   |   |   |   |                              |                                |  |   | 20    | CAN SW: Green CAN Low: White CAN High: Green   |
| Aura                  |                 |    |    |    |    |    |    |    |    |   |   |   |   |   |   |   |   |   |   |   |   |   |   |   |   |   |                              |                                |  |   | 15    | CAN SW: Green Data Keyless: Lt. Green  |
| Outlook               |                 |    |    |    |    |    |    |    |    |   |   |   |   |   |   |   |   |   |   |   |   |   |   |   |   |   |                              |                                |  |   | 16    | CAN SW: Green  |
| Sky                   |                 |    |    |    |    |    |    |    |    |   |   |   |   |   |   |   |   |   |   |   |   |   |   |   |   |   |                              |                                |  |   | 15    | CAN SW: Green Data Keyless: Tan/White  |
| Vue                   |                 |    |    |    |    |    |    |    |    |   |   |   |   |   |   |   |   |   |   |   |   |   |   |   |   |   |                              |                                |  |   | 16    | CAN SW: Green  |
| <b>Subaru</b>         |                 |    |    |    |    |    |    |    |    |   |   |   |   |   |   |   |   |   |   |   |   |   |   |   |   |   |                              |                                |  |   | U     |  |
| Impreza               |                 |    |    |    |    |    |    |    |    |   |   |   |   |   |   |   |   |   |   |   |   |   |   |   |   |   |                              |                                |  |   | 19    | CAN High: Pink CAN Low: Lt Green/Red   |
| Forester              |                 |    |    |    |    |    |    |    |    |   |   |   |   |   |   |   |   |   |   |   |   |   |   |   |   |   |                              |                                |  |   | 19    | CAN High: Pink CAN Low: Lt Green/Red   |
| <b>Suzuki</b>         |                 |    |    |    |    |    |    |    |    |   |   |   |   |   |   |   |   |   |   |   |   |   |   |   |   |   |                              |                                |  |   | U     |  |
| XL7                   |                 |    |    |    |    |    |    |    |    |   |   |   |   |   |   |   |   |   |   |   |   |   |   |   |   |   |                              |                                |  |   | 16    | CAN SW: Green  |
| <b>Volkswagen</b>     |                 |    |    |    |    |    |    |    |    |   |   |   |   |   |   |   |   |   |   |   |   |   |   |   |   |   |                              |                                |  |   | U     |  |
| Beetle                |                 |    |    |    |    |    |    |    |    |   |   |   |   |   |   |   |   |   |   |   |   |   |   |   |   |   |                              |                                |  |   | 2     | CAN High: Orange/Green CAN Low: Orange/Brown   |
| Golf                  |                 |    |    |    |    |    |    |    |    |   |   |   |   |   |   |   |   |   |   |   |   |   |   |   |   |   |                              |                                |  |   | 2     | CAN High: Orange/Green CAN Low: Orange/Brown   |
| Eos                   |                 |    |    |    |    |    |    |    |    |   |   |   |   |   |   |   |   |   |   |   |   |   |   |   |   |   |                              |                                |  |   | 4     | CAN High: Orange/Green CAN Low: Orange/Brown   |
| Jetta                 |                 |    |    |    |    |    |    |    |    |   |   |   |   |   |   |   |   |   |   |   |   |   |   |   |   |   |                              |                                |  |   | 4     | CAN High: Orange/Green CAN Low: Orange/Brown   |
| Passat                |                 |    |    |    |    |    |    |    |    |   |   |   |   |   |   |   |   |   |   |   |   |   |   |   |   |   |                              |                                |  |   | 4     | CAN High: Orange/Green CAN Low: Orange/Brown   |
| Rabbit                |                 |    |    |    |    |    |    |    |    |   |   |   |   |   |   |   |   |   |   |   |   |   |   |   |   |   |                              |                                |  |   | 2     | CAN High: Orange/Green CAN Low: Orange/Brown   |
| Touareg               |                 |    |    |    |    |    |    |    |    |   |   |   |   |   |   |   |   |   |   |   |   |   |   |   |   |   |                              |                                |  |   | 4     | CAN High: Orange/Green CAN Low: Orange/Brown   |
| <b>Volvo</b>          |                 |    |    |    |    |    |    |    |    |   |   |   |   |   |   |   |   |   |   |   |   |   |   |   |   |   |                              |                                |  |   | U     |  |
| C30                   |                 |    |    |    |    |    |    |    |    |   |   |   |   |   |   |   |   |   |   |   |   |   |   |   |   |   |                              |                                |  |   | 8     | CAN High: White CAN Low: Green   |
| C70                   |                 |    |    |    |    |    |    |    |    |   |   |   |   |   |   |   |   |   |   |   |   |   |   |   |   |   |                              |                                |  |   | 8     | CAN High: White CAN Low: Green   |
| S40                   |                 |    |    |    |    |    |    |    |    |   |   |   |   |   |   |   |   |   |   |   |   |   |   |   |   |   |                              |                                |  |   | 8     | CAN High: Gray/Red CAN Low: Lt. Blue/Red   |
| S60                   |                 |    |    |    |    |    |    |    |    |   |   |   |   |   |   |   |   |   |   |   |   |   |   |   |   |   |                              |                                |  |   | 7     | CAN High: White CAN Low: Green   |
| S80                   |                 |    |    |    |    |    |    |    |    |   |   |   |   |   |   |   |   |   |   |   |   |   |   |   |   |   |                              |                                |  |   | 7     | CAN High: White CAN Low: Green   |

CAN-SL2 Firm. 9.08+ See [www.ifar.ca](http://www.ifar.ca) for installation schematic / Voir [www.ifar.ca](http://www.ifar.ca) pour schéma installation

This Vehicle Fit Guide may change without notice. Visit [www.ifar.ca](http://www.ifar.ca) to get latest version. Ce Guide des véhicules peut faire l'objet de changement sans préavis. Consultez le [www.ifar.ca](http://www.ifar.ca) pour voir la plus récente version.

\*:IK = Intelli-Key  
 \*\*:Ouverture des fenêtres (Window roll down).  
 \*\*\*:Schéma de branchement (



## VEHICLE FIT GUIDE / GUIDE DES VÉHICULES

| Volvo | 01 | 02 | 03 | 04 | 05 | 06 | 07 | 08 | 09 | 10 | A | B | C | D | E | F | G | H | I | J | K | L | M | N | O | P | Q | R | S | T | U                              |
|-------|----|----|----|----|----|----|----|----|----|----|---|---|---|---|---|---|---|---|---|---|---|---|---|---|---|---|---|---|---|---|--------------------------------|
| V50   |    |    |    |    |    |    |    |    |    |    |   |   |   |   |   |   |   |   |   |   |   |   |   |   |   |   |   |   |   | 8 | CAN High: White CAN Low: Green |
| V70   |    |    |    |    |    |    |    |    |    |    |   |   |   |   |   |   |   |   |   |   |   |   |   |   |   |   |   |   |   | 7 | CAN High: White CAN Low: Green |
| XC70  |    |    |    |    |    |    |    |    |    |    |   |   |   |   |   |   |   |   |   |   |   |   |   |   |   |   |   |   |   | 7 | CAN High: White CAN Low: Green |
| XC90  |    |    |    |    |    |    |    |    |    |    |   |   |   |   |   |   |   |   |   |   |   |   |   |   |   |   |   |   |   | 7 | CAN High: White CAN Low: Green |

This Vehicle Fit Guide may change without notice. Visit [www.ifar.ca](http://www.ifar.ca) to get latest version. Ce Guide des véhicules peut faire l'objet de changement sans préavis. Consultez le [www.ifar.ca](http://www.ifar.ca) pour voir la plus récente version.

\*:IK = Intelli-Key  
 \*\*:Ouverture des fenêtres (Window roll down).  
 \*\*\*:Schéma de branchement (Wiring schematic configuration)  
 \*\*\*\*: See INT-BMW-1 Installation schematic. Voir Schéma d'installation du INT-BMW-1.  
 \*\*\*\*\*: Installation schematic coming soon. Schéma d'installation à venir.  
 ▶ Use PATS-GM2 Utilisez le PATS-GM2

Black: Noir  
 Blue: Bleu  
 Brown: Brun  
 Green: Vert  
 Gray: Gris  
 Lt: Pâle  
 Orange: Orange  
 Pink: Rose  
 Purple: Mauve  
 Red: Rouge  
 Tan: Beige  
 Yellow: Jaune  
 White: Blanc

### INSTALLATION WITH DATA-LINK / INSTALLATION AVEC DATA-LINK

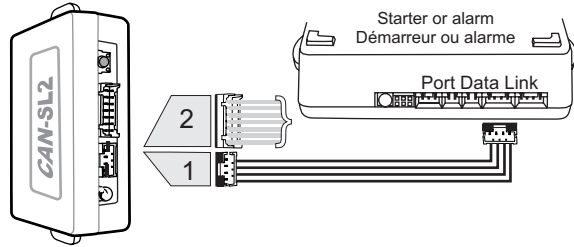

### INSTALLATION WITHOUT DATA-LINK / INSTALLATION SANS DATA-LINK

Cut off one plug of the Data-Link connector, connect the red wire to +12V and the black wire to ground.

Coupez les 4 fils à l'extrémité de l'un des deux connecteurs Data-Link. Connectez le fil rouge au 12V et le fil noir à la masse du véhicule.

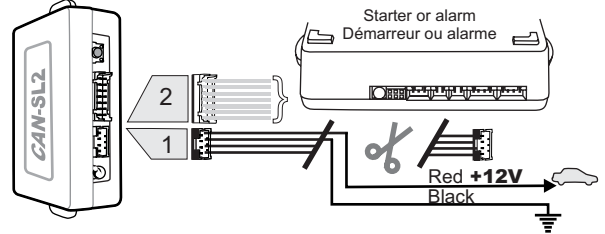

## WIRING SCHEMATIC CONFIGURATION / SCHÉMA DE BRANCHEMENT

### Configuration 1

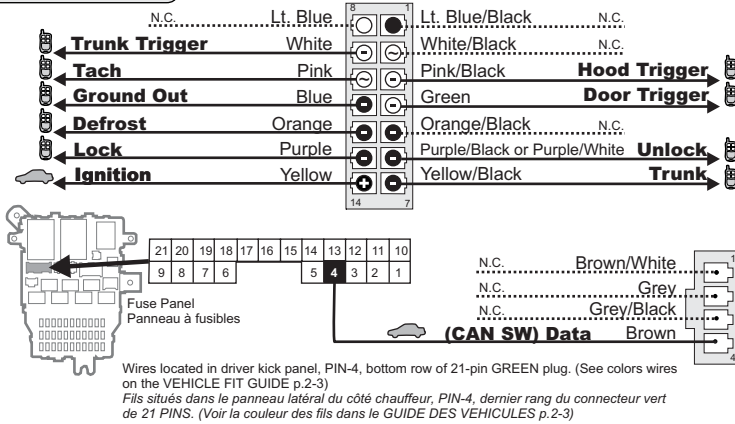

### Configuration 2

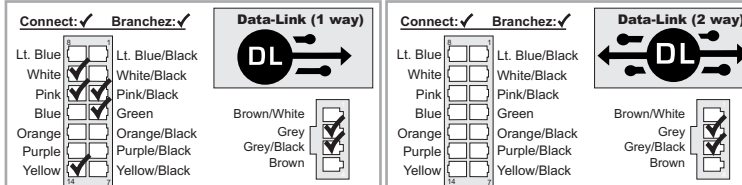
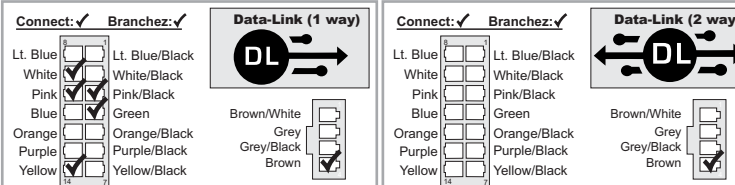
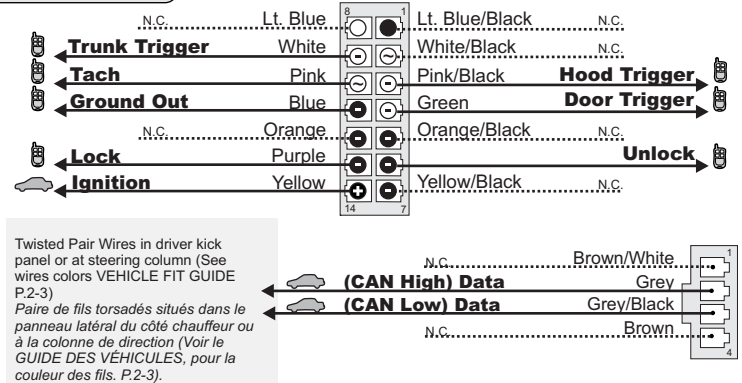

### Configuration 3

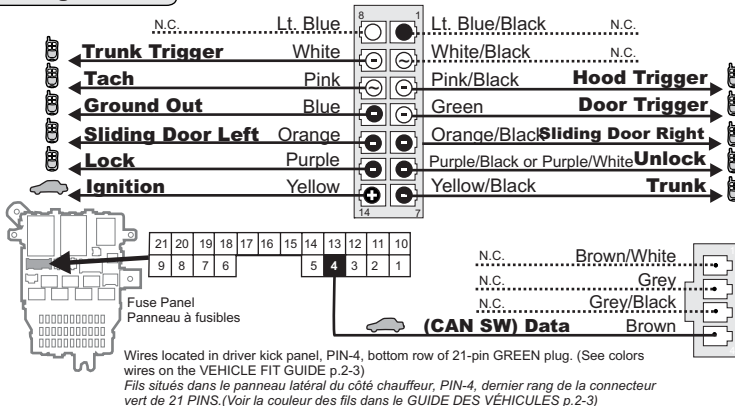

### Configuration 4

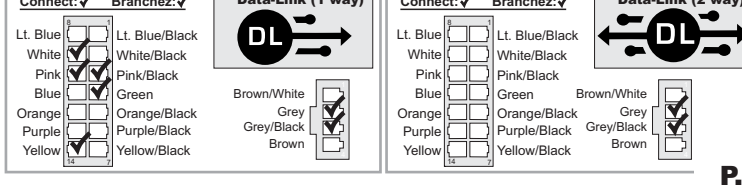
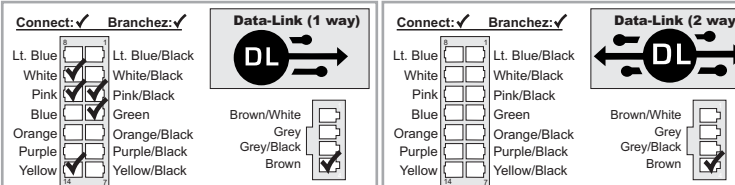
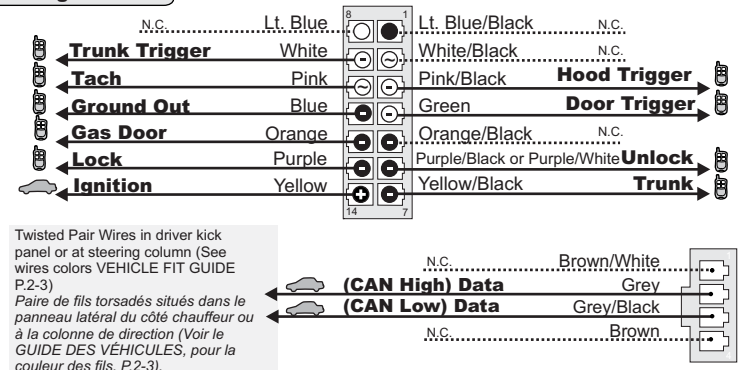

## WIRING SCHEMATIC CONFIGURATION / SCHÉMA DE BRANCHEMENT

**Configuration 5**

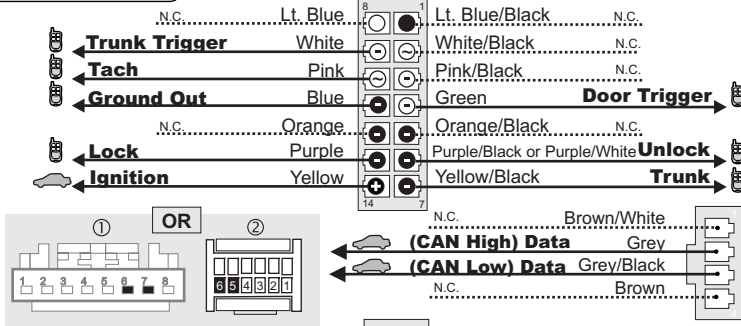

① Twisted Pair Wires located at steering column or near cluster (See colors wires on the VEHICLE FIT GUIDE p.2-3)  
 Paire de fils torsadés situés dans le harnais de la colonne de direction ou sous le tableau de bord. (Voir la couleur des fils dans le GUIDE DES VÉHICULES p.2-3)

OR

② Twisted Pair Wires located at the ignition connector (See colors wires on VEHICLE FIT GUIDE p.2-3)  
 Paire de fils torsadés situés au connecteur d'ignition. (Voir couleur des fils dans le GUIDE DES VÉHICULES p.2-3)

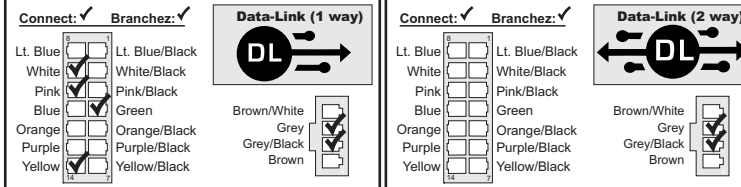

**Configuration 6**

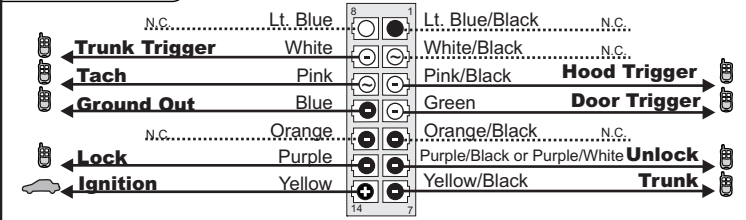

Twisted Pair Wires in driver kick panel (See wires colors VEHICLE FIT GUIDE P.2-3)  
 Paire de fils torsadés situés dans le panneau latéral du côté chauffeur. (Voir le GUIDE DES VÉHICULES, pour la couleur des fils. P.2-3)

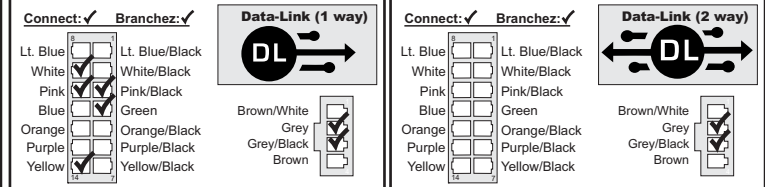
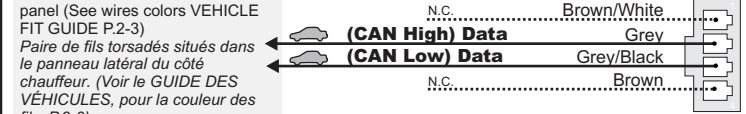

**Configuration 7**

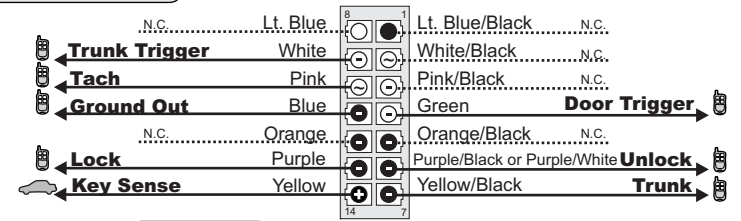

2005 +  
 2004 - : Twisted Pair Wires located in the driver kick panel (See colors wires on the VEHICLE FIT GUIDE p.2-3)  
 Paire de fils torsadés situés dans le panneau latéral du côté chauffeur. (Voir la couleur des fils dans le GUIDE DES VÉHICULES p.2-3)

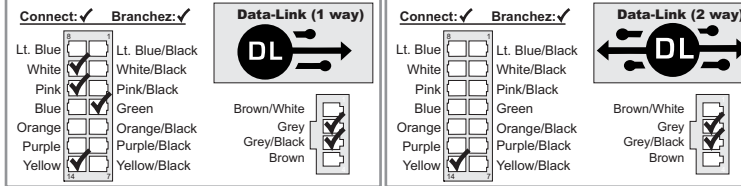

**Configuration 8**

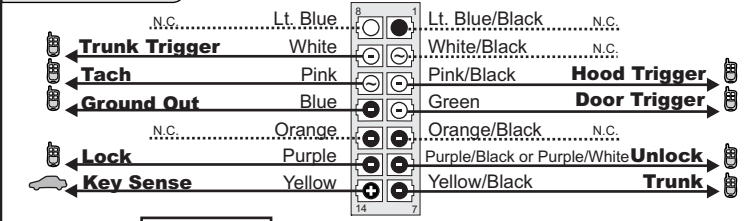

2005 +  
 2004 - : Twisted Pair Wires located in the driver kick panel (See colors wires on the VEHICLE FIT GUIDE p.2-3)  
 Paire de fils torsadés situés dans le panneau latéral du côté chauffeur. (Voir la couleur des fils dans le GUIDE DES VÉHICULES p.2-3)

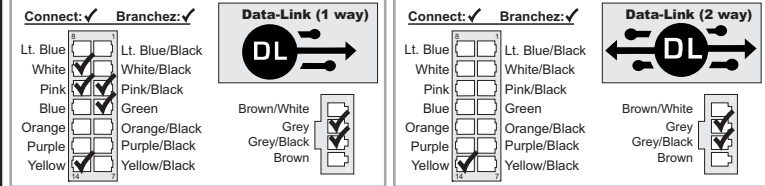

**Configuration 9**

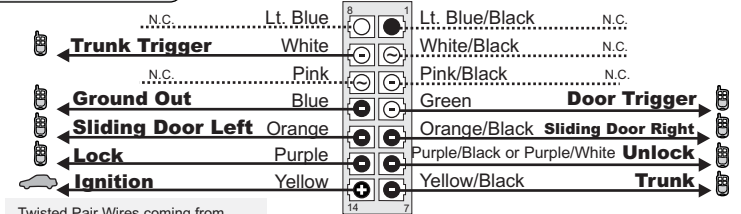

Twisted Pair Wires coming from the door, located in the driver kick panel. (See colors wires on the VEHICLE FIT GUIDE p.2-3)  
 Paire de fils torsadés provenant de la porte, située dans le panneau latéral de la porte du côté chauffeur. (Voir la couleur des fils dans le GUIDE DES VÉHICULES p.2-3)

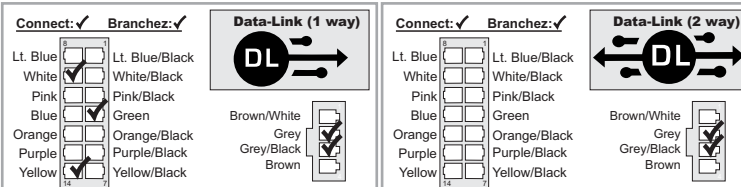

**Configuration 10**

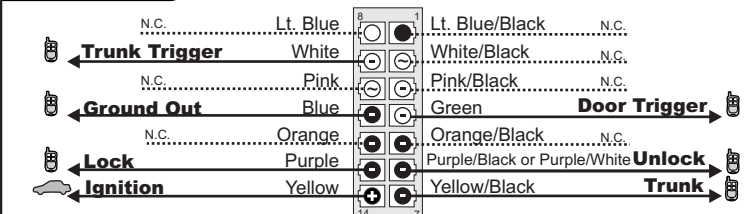

Twisted Pair Wires coming from the door, located in the driver kick panel (See colors wires on the VEHICLE FIT GUIDE p.2-3)  
 Paire de fils torsadés provenant de la porte, située dans le panneau latéral côté conducteur. (Voir la couleur des fils dans le GUIDE DES VÉHICULES p.2-3)

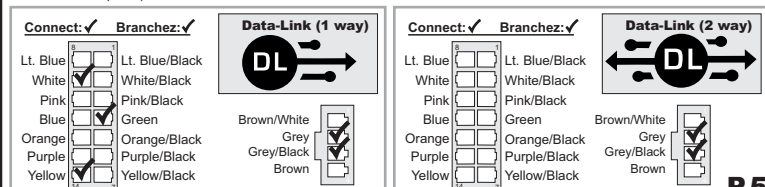

## WIRING SCHEMATIC CONFIGURATION / SCHÉMA DE BRANCHEMENT

### Configuration 11

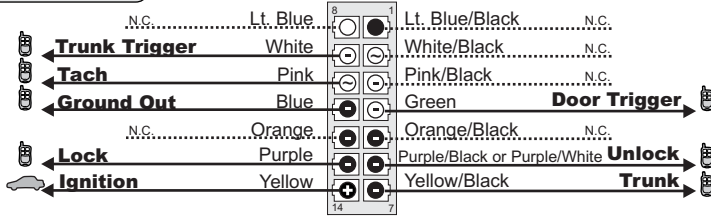

Twisted Pair Wires located under the glove compartment at the BCM. (See colors wires on the VEHICLE FIT GUIDE p.2-3)  
Paire de fils torsadés situés sous le coffre à gant au BCM. (Voir la couleur des fils dans le GUIDE DES VÉHICULES p.2-3)

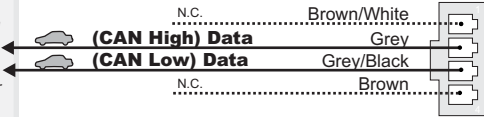

#### Connect: ✓ Branchez: ✓



#### Data-Link (1 way)

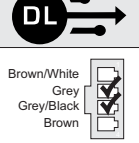

#### Connect: ✓ Branchez: ✓



#### Data-Link (2 way)

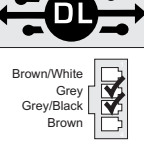

### Configuration 12

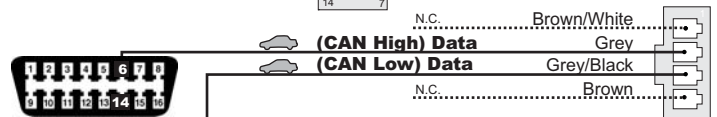
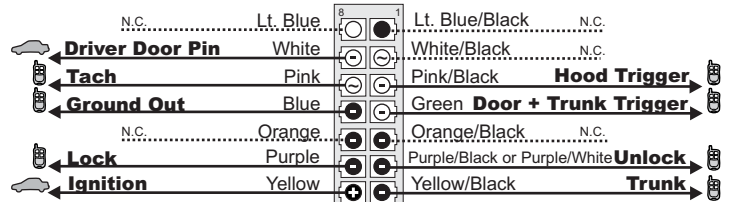

#### Connect: ✓ Branchez: ✓



#### Data-Link (1 way)

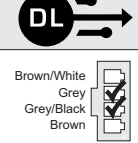

#### Connect: ✓ Branchez: ✓

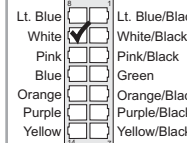

#### Data-Link (2 way)

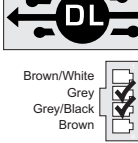

### Configuration 13

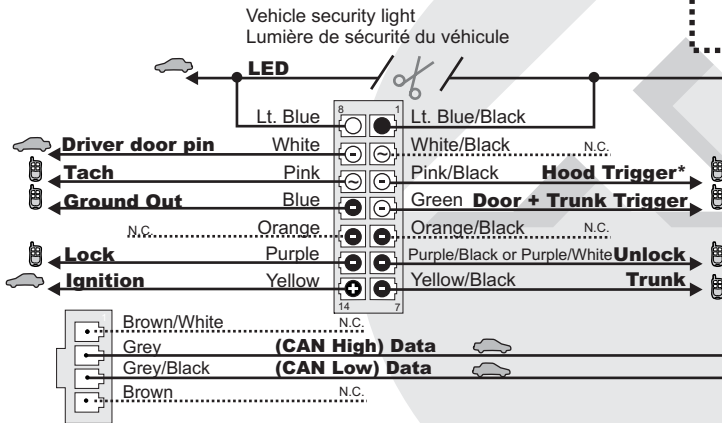

To control OEM Alarm on vehicle (NON INTELLI-KEY vehicles) add the following wires to the empty pins on the BCM.  
Pour contrôler l'alarme d'origine des véhicules NON ÉQUIPÉS DE L'INTELLI-KEY ajoutez des fils dans les espaces vides du BCM.

\* Only if the vehicle is equipped with a hood pin.  
\* Seulement si le véhicule est équipé de la pin de capot.

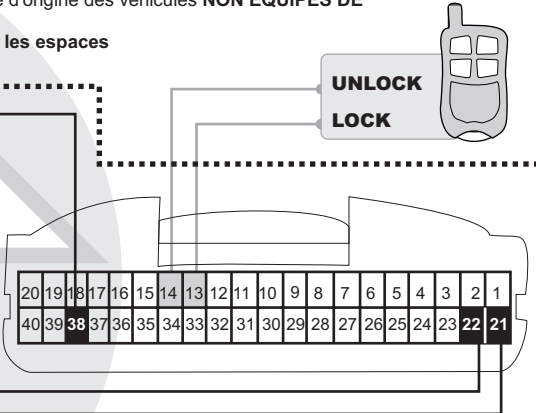

Front view of the BCM connector located on the driver kick panel or above the acceleration pedal. For the Versa vehicle: Connector located behind the glove compartment.  
Vue de face de la prise du BCM situé dans le panneau latéral conducteur ou au-dessus de la pédale d'accélération. Pour les véhicules Versa: Connecteur situé derrière le coffre à gant.

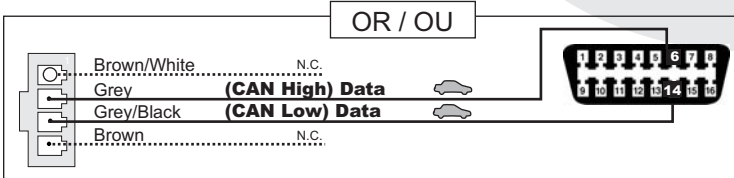

#### Connect: ✓ Branchez: ✓

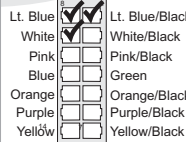

#### Data-Link (2 way)

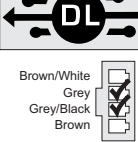

#### Connect: ✓ Branchez: ✓



#### Data-Link (1 way)

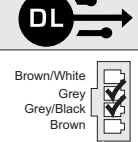

### Configuration 14

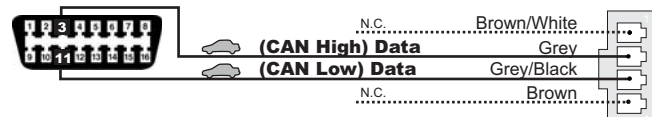
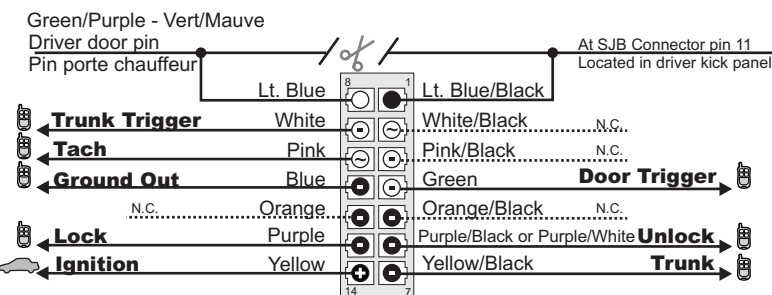

#### Connect: ✓ Branchez: ✓



#### Data-Link (1 way)



#### Connect: ✓ Branchez: ✓

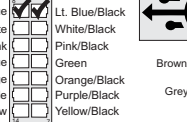

#### Data-Link (2 way)

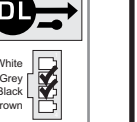

### WIRING SCHEMATIC CONFIGURATION / SCHÉMA DE BRANCHEMENT

#### Configuration 15

Remote-Starter / Démarreur à distance

Connection for Transponder bypass./ Connexion pour le contournement transpondeur.

**WARNING:** All Ignition and accessory wires of the remote starter must be connected at the ignition barrel.

**ATTENTION:** Les fils d'ignition et d'accessoire du démarreur à distance doivent être connectés au barillet d'ignition.

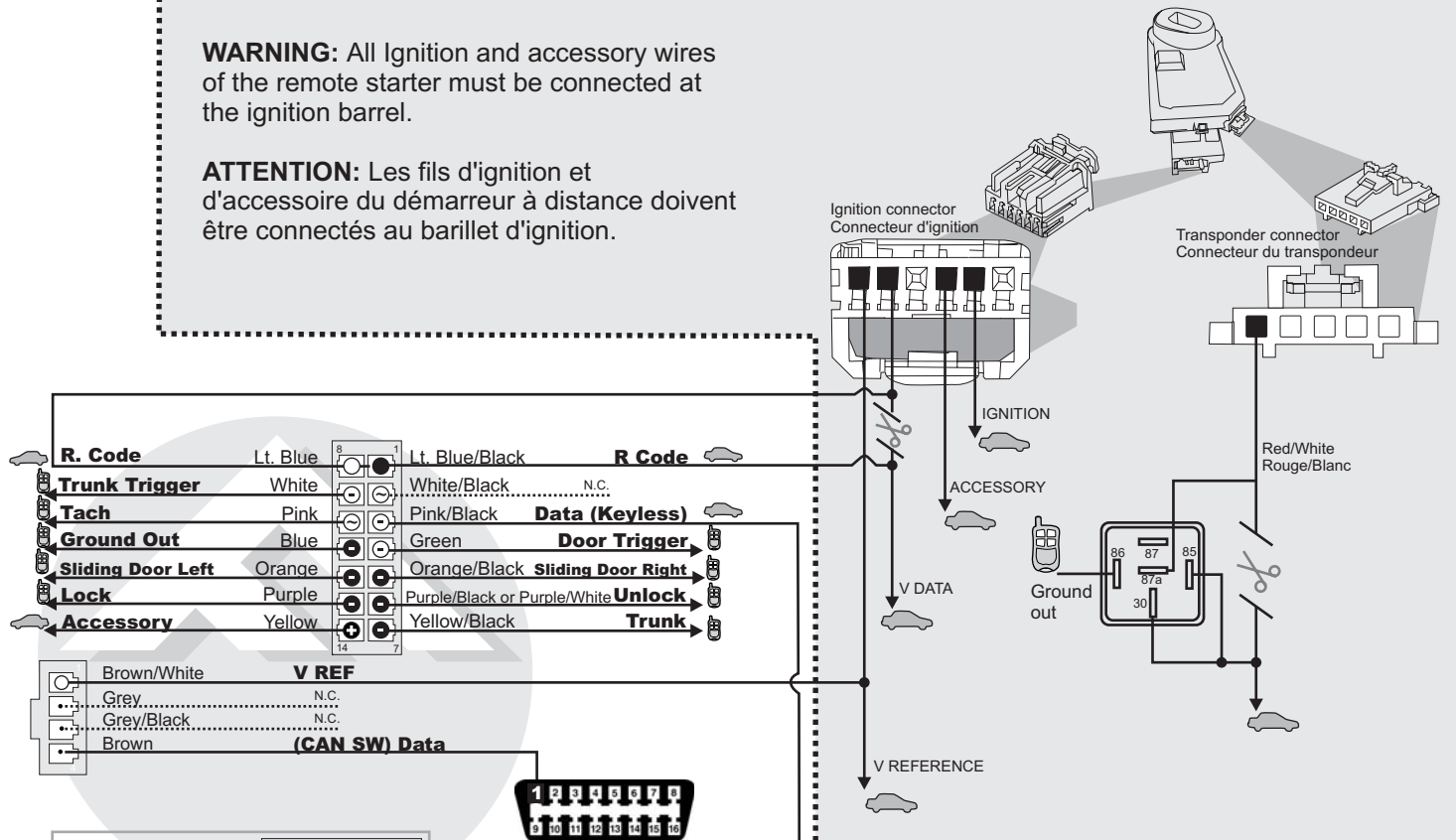

**Connect: ✓ Branchez: ✓**

|                                     |          |                                     |                |
|-------------------------------------|----------|-------------------------------------|----------------|
| <input checked="" type="checkbox"/> | Lt. Blue | <input checked="" type="checkbox"/> | Lt. Blue/Black |
| <input checked="" type="checkbox"/> | White    | <input checked="" type="checkbox"/> | White/Black    |
| <input checked="" type="checkbox"/> | Pink     | <input checked="" type="checkbox"/> | Pink/Black     |
| <input checked="" type="checkbox"/> | Blue     | <input checked="" type="checkbox"/> | Green          |
| <input checked="" type="checkbox"/> | Orange   | <input checked="" type="checkbox"/> | Orange/Black   |
| <input checked="" type="checkbox"/> | Purple   | <input checked="" type="checkbox"/> | Purple/Black   |
| <input checked="" type="checkbox"/> | Yellow   | <input checked="" type="checkbox"/> | Yellow/Black   |

**Data-Link (1 way)**

**DL** →

|                                     |             |
|-------------------------------------|-------------|
| <input checked="" type="checkbox"/> | Brown/White |
| <input checked="" type="checkbox"/> | Grey        |
| <input checked="" type="checkbox"/> | Grey/Black  |
| <input checked="" type="checkbox"/> | Brown       |

**Connect: ✓ Branchez: ✓**

|                                     |          |                                     |                |
|-------------------------------------|----------|-------------------------------------|----------------|
| <input checked="" type="checkbox"/> | Lt. Blue | <input checked="" type="checkbox"/> | Lt. Blue/Black |
| <input checked="" type="checkbox"/> | White    | <input checked="" type="checkbox"/> | White/Black    |
| <input checked="" type="checkbox"/> | Pink     | <input checked="" type="checkbox"/> | Pink/Black     |
| <input checked="" type="checkbox"/> | Blue     | <input checked="" type="checkbox"/> | Green          |
| <input checked="" type="checkbox"/> | Orange   | <input checked="" type="checkbox"/> | Orange/Black   |
| <input checked="" type="checkbox"/> | Purple   | <input checked="" type="checkbox"/> | Purple/Black   |
| <input checked="" type="checkbox"/> | Yellow   | <input checked="" type="checkbox"/> | Yellow/Black   |

**Data-Link (2 way)**

← **DL** →

|                                     |             |
|-------------------------------------|-------------|
| <input checked="" type="checkbox"/> | Brown/White |
| <input checked="" type="checkbox"/> | Grey        |
| <input checked="" type="checkbox"/> | Grey/Black  |
| <input checked="" type="checkbox"/> | Brown       |

For OEM door lock control and trunk release  
Pour contrôle du verrouillage des portes et valise.

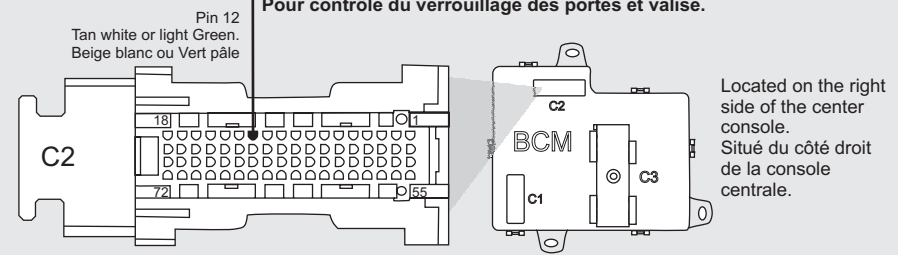

Connection needed for vehicles 2006 and older. (Not required for vehicles 2007 and newer.)  
Effectuez ce branchement pour les véhicules 2006 et moins. (sur véhicules 2007 et plus branchement non requis)

| Vehicles / Véhicules | Wire colors / Couleur(s) des fils |             |           |          |        |               |
|----------------------|-----------------------------------|-------------|-----------|----------|--------|---------------|
|                      | V REFERENCE                       | V DATA      | ACCESSORY | IGNITION | CAN SW | DATA KEY LESS |
| <b>Chevrolet</b>     |                                   |             |           |          |        |               |
| Cobalt               | White/Black                       | White       | Brown     | Yellow   | Green  | Tan/White     |
| HHR                  | White/Black                       | White       | Brown     | Yellow   | Green  | Tan/White     |
| Malibu               | White/Black                       | White       | Brown     | Pink     | Green  | Lt Green      |
| <b>Pontiac</b>       |                                   |             |           |          |        |               |
| G5                   | White/Black                       | White       | Brown     | Pink     | Green  | Tan/White     |
| G6                   | White/Black                       | White       | Brown     | Pink     | Green  | Lt Green      |
| Pursuit              | White/Black                       | White       | Brown     | Yellow   | Green  | Tan/White     |
| Solstice             | White/Black                       | White       | Brown     | Yellow   | Green  | Tan/White     |
| <b>Saturn</b>        |                                   |             |           |          |        |               |
| Aura                 | White                             | White/Black | Brown     | Pink     | Green  | Lt Green      |
| Sky                  | White/Black                       | White       | Brown     | Yellow   | Green  | Tan/White     |

White: Blanc Black: Noir Blue: Bleu Brown: Brun Green: Vert Gray: Gris Lt: Pâle Orange: Orange Pink: Rose Purple: Mauve Red: Rouge Tan: Beige Yellow: Jaune



## WIRING SCHEMATIC CONFIGURATION / SCHÉMA DE BRANCHEMENT

### Configuration 16

#### Remote-Starter / Démarreur à distance

Connection for Transponder bypass. / Connexion pour le contournement transpondeur.

**WARNING:** All Ignition and accessory wires of the remote starter must be connected at the ignition barrel.  
**ATTENTION:** Les fils d'ignition et d'accessoire du démarreur à distance doivent être connectés au barillet d'ignition.

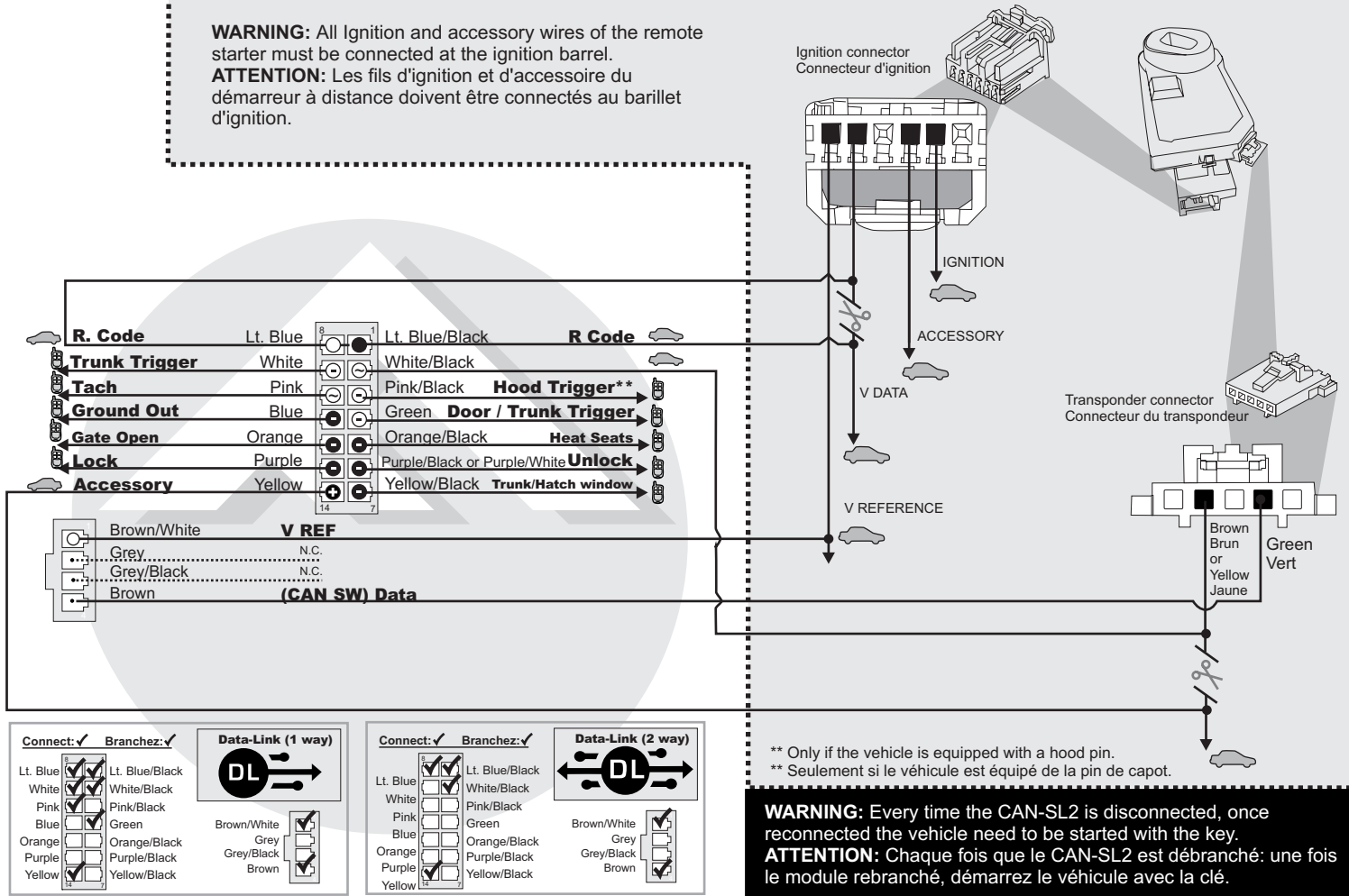

| Vehicles / Véhicules | Wire colors / Couleur(s) des fils |             |           |          |        |               |
|----------------------|-----------------------------------|-------------|-----------|----------|--------|---------------|
|                      | V REFERENCE                       | V DATA      | ACCESSORY | IGNITION | CAN SW | DATA KEY LESS |
| <b>Buick</b>         |                                   |             |           |          |        |               |
| Enclave              | White                             | White/Black | Brown     | Pink     | Green  | N.A.          |
| Lucerne              | White/Black                       | White       | Brown     | Pink     | Green  | N.A.          |
| <b>Cadillac</b>      |                                   |             |           |          |        |               |
| CTS                  | White/Black                       | White       | Brown     | Pink     | Green  | N.A.          |
| DTS                  | White/Black                       | White       | Brown     | Pink     | Green  | N.A.          |
| Escalade             | White                             | Pink/Black  | Yellow    | Pink     | Green  | N.A.          |
| SRX                  | White/Black                       | White       | Brown     | Pink     | Green  | N.A.          |
| STS                  |                                   |             |           |          | Green  | N.A.          |
| <b>Chevrolet</b>     |                                   |             |           |          |        |               |
| Avalanche            | White                             | Pink/Black  | Yellow    | Pink     | Green  | N.A.          |
| CK Pickup            | White                             | Pink/Black  | Yellow    | Pink     | Green  | N.A.          |
| Equinox              | White/Black                       | White       | Brown     | Pink     | Green  | N.A.          |
| Express              | White                             | Pink        | Brown     | Pink     | Green  | N.A.          |
| Impala               | White/Black                       | White       | Brown     | Pink     | Green  | N.A.          |
| Monte Carlo          | White/Black                       | White       | Brown     | Pink     | Green  | N.A.          |
| Silverado            | White                             | Pink/Black  | Yellow    | Pink     | Green  | N.A.          |
| Tahoe                | White                             | Pink/Black  | Yellow    | Pink     | Green  | N.A.          |
| Suburban             | White                             | Pink/Black  | Yellow    | Pink     | Green  | N.A.          |
| <b>GMC</b>           |                                   |             |           |          |        |               |
| Acadia               | White/Black                       | White       | Brown     | Pink     | Green  | N.A.          |
| Savana               | White                             | White/Black | Yellow    | Pink     | Green  | N.A.          |
| Sierra               | White                             | Pink/Black  | Yellow    | Pink     | Green  | N.A.          |
| Suburban             | White                             | Pink/Black  | Yellow    | Pink     | Green  | N.A.          |
| Yukon                | White                             | Pink/Black  | Yellow    | Pink     | Green  | N.A.          |
| <b>Saturn</b>        |                                   |             |           |          |        |               |
| Outlook              | White                             | White/Black | Brown     | Pink     | Green  | N.A.          |
| Vue                  | White                             | White/Black | Yellow    | Pink     | Green  | N.A.          |
| <b>Pontiac</b>       |                                   |             |           |          |        |               |
| G8                   | White/Black                       | White       | Brown     | Pink     | Green  | N.A.          |
| Torrent              | White/Black                       | White       | Brown     | Pink     | Green  | N.A.          |
| <b>Suzuki</b>        |                                   |             |           |          |        |               |
| XL7                  | White/Black                       | White       | Brown     | Pink     | Green  | N.A.          |



### WIRING SCHEMATIC CONFIGURATION / SCHÉMA DE BRANCHEMENT

#### Configuration 17

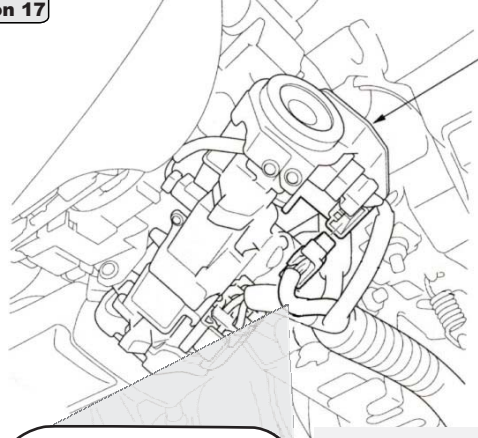

Wires located at steering column immobilizer control unit  
Fils situés à la colonne de direction au module de contrôle de la clé à puce

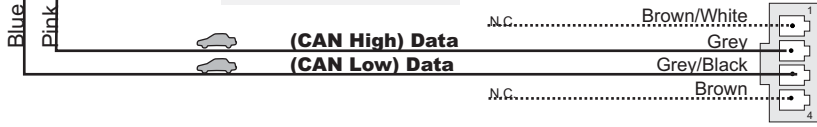
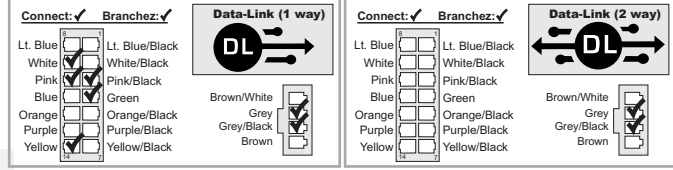
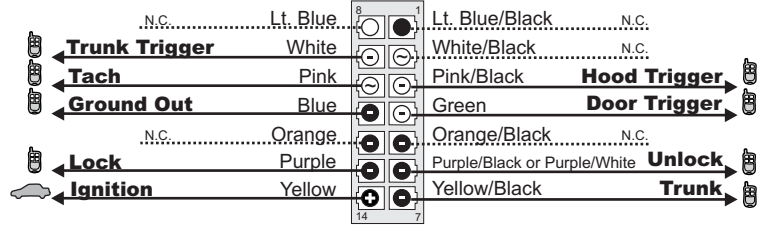

#### Configuration 18

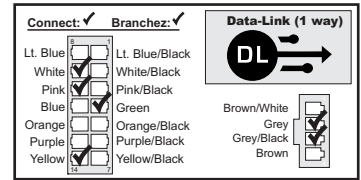
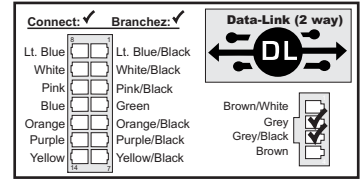
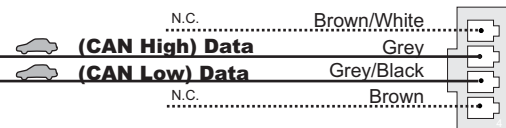
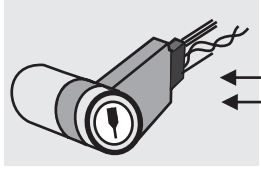
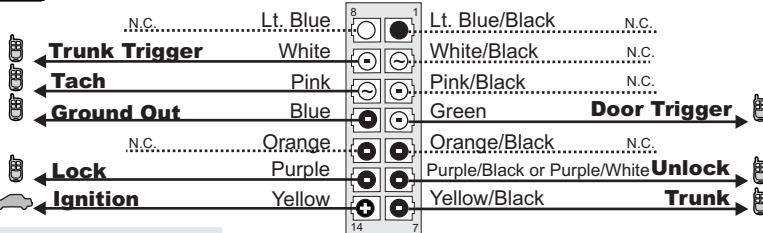

Twisted Pair Wires located at steering column or near cluster (See colors wires on the VEHICLE FIT GUIDE p.2-3)  
Paire de fils torsadés situés dans le harnais de la colonne de direction ou sous le tableau de bord. (Voir la couleur des fils dans le GUIDE DES VÉHICULES p.2-3)

#### Configuration 19

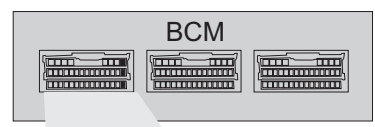
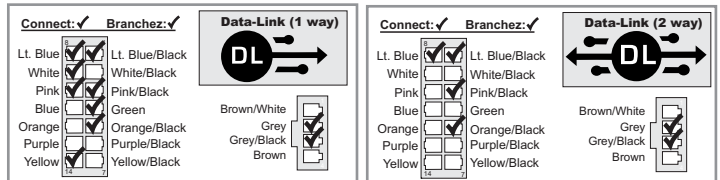

BCM located directly below the steering column.  
BCM situés directement sous la colonne de direction

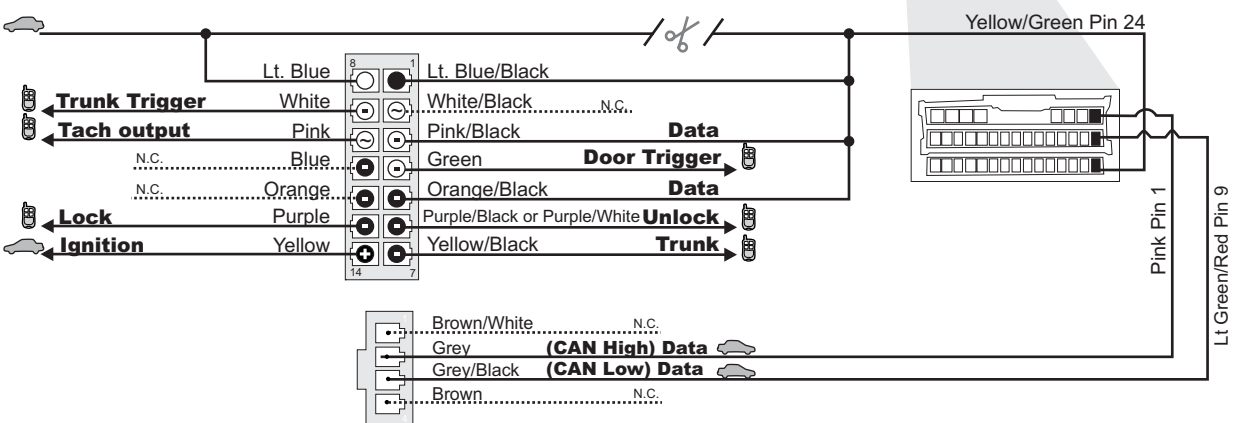



### WIRING SCHEMATIC CONFIGURATION / SCHÉMA DE BRANCHEMENT

#### Configuration 20



**REMOTE STARTER**  
The remote starters starter output is not required.

**DÉMARREUR À DISTANCE**  
La sortie Start du démarreur à distance n'est pas requise pour ce véhicule.

Ignition  
Accessory

Make 10 loops with a 22 to 26 gauge wire around the factory key.  
Faire 10 tours autour de la clé d'origine avec un fil de calibre 22 à 26.

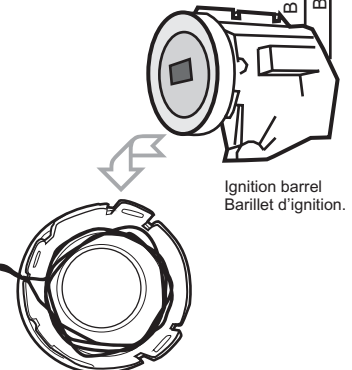
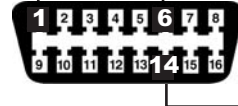
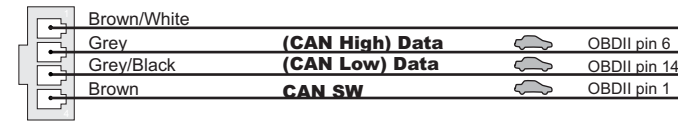
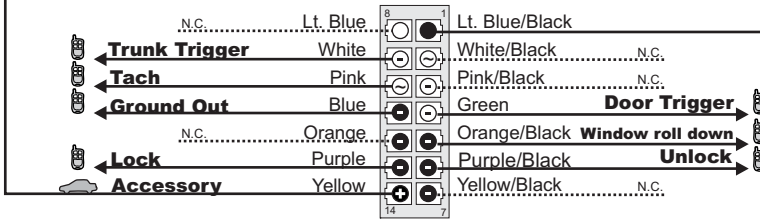

- 1 Remove the plastic cover of the Ignition barrel  
Retirez le couvert de plastique du barillet d'ignition.
- 2 Wrap the wire around the inside of the plastic ring 4 times.  
Faire 4 tours à l'intérieur de l'anneau de plastique avec le fil.

|   |                                     |                          |       |                                     |      |                                     |      |                                     |        |                          |        |                          |        |                                     |  |                |                          |             |                          |            |                          |       |                          |              |                          |              |                          |              |                          |   |             |                                     |      |                                     |            |                                     |       |                                     |   |          |                                     |       |                          |      |                          |      |                          |        |                          |        |                          |        |                                     |  |                |                          |             |                          |            |                          |       |                          |              |                          |              |                          |              |                          |   |             |                                     |      |                                     |            |                                     |       |                                     |
|---|-------------------------------------|--------------------------|-------|-------------------------------------|------|-------------------------------------|------|-------------------------------------|--------|--------------------------|--------|--------------------------|--------|-------------------------------------|--|----------------|--------------------------|-------------|--------------------------|------------|--------------------------|-------|--------------------------|--------------|--------------------------|--------------|--------------------------|--------------|--------------------------|---|-------------|-------------------------------------|------|-------------------------------------|------------|-------------------------------------|-------|-------------------------------------|---|----------|-------------------------------------|-------|--------------------------|------|--------------------------|------|--------------------------|--------|--------------------------|--------|--------------------------|--------|-------------------------------------|--|----------------|--------------------------|-------------|--------------------------|------------|--------------------------|-------|--------------------------|--------------|--------------------------|--------------|--------------------------|--------------|--------------------------|---|-------------|-------------------------------------|------|-------------------------------------|------------|-------------------------------------|-------|-------------------------------------|
| <p><b>Connect: ✓ Branchez: ✓</b></p> <table border="1"> <tr><td>Lt. Blue</td><td><input type="checkbox"/></td></tr> <tr><td>White</td><td><input checked="" type="checkbox"/></td></tr> <tr><td>Pink</td><td><input checked="" type="checkbox"/></td></tr> <tr><td>Blue</td><td><input checked="" type="checkbox"/></td></tr> <tr><td>Orange</td><td><input type="checkbox"/></td></tr> <tr><td>Purple</td><td><input type="checkbox"/></td></tr> <tr><td>Yellow</td><td><input checked="" type="checkbox"/></td></tr> </table> | Lt. Blue                            | <input type="checkbox"/> | White | <input checked="" type="checkbox"/> | Pink | <input checked="" type="checkbox"/> | Blue | <input checked="" type="checkbox"/> | Orange | <input type="checkbox"/> | Purple | <input type="checkbox"/> | Yellow | <input checked="" type="checkbox"/> | <p><b>DL →</b></p> <table border="1"> <tr><td>Lt. Blue/Black</td><td><input type="checkbox"/></td></tr> <tr><td>White/Black</td><td><input type="checkbox"/></td></tr> <tr><td>Pink/Black</td><td><input type="checkbox"/></td></tr> <tr><td>Green</td><td><input type="checkbox"/></td></tr> <tr><td>Orange/Black</td><td><input type="checkbox"/></td></tr> <tr><td>Purple/Black</td><td><input type="checkbox"/></td></tr> <tr><td>Yellow/Black</td><td><input type="checkbox"/></td></tr> </table> | Lt. Blue/Black | <input type="checkbox"/> | White/Black | <input type="checkbox"/> | Pink/Black | <input type="checkbox"/> | Green | <input type="checkbox"/> | Orange/Black | <input type="checkbox"/> | Purple/Black | <input type="checkbox"/> | Yellow/Black | <input type="checkbox"/> | <p><b>Data-Link (1 way)</b></p> <table border="1"> <tr><td>Brown/White</td><td><input checked="" type="checkbox"/></td></tr> <tr><td>Grey</td><td><input checked="" type="checkbox"/></td></tr> <tr><td>Grey/Black</td><td><input checked="" type="checkbox"/></td></tr> <tr><td>Brown</td><td><input checked="" type="checkbox"/></td></tr> </table> | Brown/White | <input checked="" type="checkbox"/> | Grey | <input checked="" type="checkbox"/> | Grey/Black | <input checked="" type="checkbox"/> | Brown | <input checked="" type="checkbox"/> | <p><b>Connect: ✓ Branchez: ✓</b></p> <table border="1"> <tr><td>Lt. Blue</td><td><input checked="" type="checkbox"/></td></tr> <tr><td>White</td><td><input type="checkbox"/></td></tr> <tr><td>Pink</td><td><input type="checkbox"/></td></tr> <tr><td>Blue</td><td><input type="checkbox"/></td></tr> <tr><td>Orange</td><td><input type="checkbox"/></td></tr> <tr><td>Purple</td><td><input type="checkbox"/></td></tr> <tr><td>Yellow</td><td><input checked="" type="checkbox"/></td></tr> </table> | Lt. Blue | <input checked="" type="checkbox"/> | White | <input type="checkbox"/> | Pink | <input type="checkbox"/> | Blue | <input type="checkbox"/> | Orange | <input type="checkbox"/> | Purple | <input type="checkbox"/> | Yellow | <input checked="" type="checkbox"/> | <p><b>DL ↔</b></p> <table border="1"> <tr><td>Lt. Blue/Black</td><td><input type="checkbox"/></td></tr> <tr><td>White/Black</td><td><input type="checkbox"/></td></tr> <tr><td>Pink/Black</td><td><input type="checkbox"/></td></tr> <tr><td>Green</td><td><input type="checkbox"/></td></tr> <tr><td>Orange/Black</td><td><input type="checkbox"/></td></tr> <tr><td>Purple/Black</td><td><input type="checkbox"/></td></tr> <tr><td>Yellow/Black</td><td><input type="checkbox"/></td></tr> </table> | Lt. Blue/Black | <input type="checkbox"/> | White/Black | <input type="checkbox"/> | Pink/Black | <input type="checkbox"/> | Green | <input type="checkbox"/> | Orange/Black | <input type="checkbox"/> | Purple/Black | <input type="checkbox"/> | Yellow/Black | <input type="checkbox"/> | <p><b>Data-Link (2 way)</b></p> <table border="1"> <tr><td>Brown/White</td><td><input checked="" type="checkbox"/></td></tr> <tr><td>Grey</td><td><input checked="" type="checkbox"/></td></tr> <tr><td>Grey/Black</td><td><input checked="" type="checkbox"/></td></tr> <tr><td>Brown</td><td><input checked="" type="checkbox"/></td></tr> </table> | Brown/White | <input checked="" type="checkbox"/> | Grey | <input checked="" type="checkbox"/> | Grey/Black | <input checked="" type="checkbox"/> | Brown | <input checked="" type="checkbox"/> |
| Lt. Blue  | <input type="checkbox"/>            |                          |       |                                     |      |                                     |      |                                     |        |                          |        |                          |        |                                     |  |                |                          |             |                          |            |                          |       |                          |              |                          |              |                          |              |                          |   |             |                                     |      |                                     |            |                                     |       |                                     |   |          |                                     |       |                          |      |                          |      |                          |        |                          |        |                          |        |                                     |  |                |                          |             |                          |            |                          |       |                          |              |                          |              |                          |              |                          |   |             |                                     |      |                                     |            |                                     |       |                                     |
| White   | <input checked="" type="checkbox"/> |                          |       |                                     |      |                                     |      |                                     |        |                          |        |                          |        |                                     |  |                |                          |             |                          |            |                          |       |                          |              |                          |              |                          |              |                          |   |             |                                     |      |                                     |            |                                     |       |                                     |   |          |                                     |       |                          |      |                          |      |                          |        |                          |        |                          |        |                                     |  |                |                          |             |                          |            |                          |       |                          |              |                          |              |                          |              |                          |   |             |                                     |      |                                     |            |                                     |       |                                     |
| Pink  | <input checked="" type="checkbox"/> |                          |       |                                     |      |                                     |      |                                     |        |                          |        |                          |        |                                     |  |                |                          |             |                          |            |                          |       |                          |              |                          |              |                          |              |                          |   |             |                                     |      |                                     |            |                                     |       |                                     |   |          |                                     |       |                          |      |                          |      |                          |        |                          |        |                          |        |                                     |  |                |                          |             |                          |            |                          |       |                          |              |                          |              |                          |              |                          |   |             |                                     |      |                                     |            |                                     |       |                                     |
| Blue  | <input checked="" type="checkbox"/> |                          |       |                                     |      |                                     |      |                                     |        |                          |        |                          |        |                                     |  |                |                          |             |                          |            |                          |       |                          |              |                          |              |                          |              |                          |   |             |                                     |      |                                     |            |                                     |       |                                     |   |          |                                     |       |                          |      |                          |      |                          |        |                          |        |                          |        |                                     |  |                |                          |             |                          |            |                          |       |                          |              |                          |              |                          |              |                          |   |             |                                     |      |                                     |            |                                     |       |                                     |
| Orange  | <input type="checkbox"/>            |                          |       |                                     |      |                                     |      |                                     |        |                          |        |                          |        |                                     |  |                |                          |             |                          |            |                          |       |                          |              |                          |              |                          |              |                          |   |             |                                     |      |                                     |            |                                     |       |                                     |   |          |                                     |       |                          |      |                          |      |                          |        |                          |        |                          |        |                                     |  |                |                          |             |                          |            |                          |       |                          |              |                          |              |                          |              |                          |   |             |                                     |      |                                     |            |                                     |       |                                     |
| Purple  | <input type="checkbox"/>            |                          |       |                                     |      |                                     |      |                                     |        |                          |        |                          |        |                                     |  |                |                          |             |                          |            |                          |       |                          |              |                          |              |                          |              |                          |   |             |                                     |      |                                     |            |                                     |       |                                     |   |          |                                     |       |                          |      |                          |      |                          |        |                          |        |                          |        |                                     |  |                |                          |             |                          |            |                          |       |                          |              |                          |              |                          |              |                          |   |             |                                     |      |                                     |            |                                     |       |                                     |
| Yellow  | <input checked="" type="checkbox"/> |                          |       |                                     |      |                                     |      |                                     |        |                          |        |                          |        |                                     |  |                |                          |             |                          |            |                          |       |                          |              |                          |              |                          |              |                          |   |             |                                     |      |                                     |            |                                     |       |                                     |   |          |                                     |       |                          |      |                          |      |                          |        |                          |        |                          |        |                                     |  |                |                          |             |                          |            |                          |       |                          |              |                          |              |                          |              |                          |   |             |                                     |      |                                     |            |                                     |       |                                     |
| Lt. Blue/Black  | <input type="checkbox"/>            |                          |       |                                     |      |                                     |      |                                     |        |                          |        |                          |        |                                     |  |                |                          |             |                          |            |                          |       |                          |              |                          |              |                          |              |                          |   |             |                                     |      |                                     |            |                                     |       |                                     |   |          |                                     |       |                          |      |                          |      |                          |        |                          |        |                          |        |                                     |  |                |                          |             |                          |            |                          |       |                          |              |                          |              |                          |              |                          |   |             |                                     |      |                                     |            |                                     |       |                                     |
| White/Black   | <input type="checkbox"/>            |                          |       |                                     |      |                                     |      |                                     |        |                          |        |                          |        |                                     |  |                |                          |             |                          |            |                          |       |                          |              |                          |              |                          |              |                          |   |             |                                     |      |                                     |            |                                     |       |                                     |   |          |                                     |       |                          |      |                          |      |                          |        |                          |        |                          |        |                                     |  |                |                          |             |                          |            |                          |       |                          |              |                          |              |                          |              |                          |   |             |                                     |      |                                     |            |                                     |       |                                     |
| Pink/Black  | <input type="checkbox"/>            |                          |       |                                     |      |                                     |      |                                     |        |                          |        |                          |        |                                     |  |                |                          |             |                          |            |                          |       |                          |              |                          |              |                          |              |                          |   |             |                                     |      |                                     |            |                                     |       |                                     |   |          |                                     |       |                          |      |                          |      |                          |        |                          |        |                          |        |                                     |  |                |                          |             |                          |            |                          |       |                          |              |                          |              |                          |              |                          |   |             |                                     |      |                                     |            |                                     |       |                                     |
| Green   | <input type="checkbox"/>            |                          |       |                                     |      |                                     |      |                                     |        |                          |        |                          |        |                                     |  |                |                          |             |                          |            |                          |       |                          |              |                          |              |                          |              |                          |   |             |                                     |      |                                     |            |                                     |       |                                     |   |          |                                     |       |                          |      |                          |      |                          |        |                          |        |                          |        |                                     |  |                |                          |             |                          |            |                          |       |                          |              |                          |              |                          |              |                          |   |             |                                     |      |                                     |            |                                     |       |                                     |
| Orange/Black  | <input type="checkbox"/>            |                          |       |                                     |      |                                     |      |                                     |        |                          |        |                          |        |                                     |  |                |                          |             |                          |            |                          |       |                          |              |                          |              |                          |              |                          |   |             |                                     |      |                                     |            |                                     |       |                                     |   |          |                                     |       |                          |      |                          |      |                          |        |                          |        |                          |        |                                     |  |                |                          |             |                          |            |                          |       |                          |              |                          |              |                          |              |                          |   |             |                                     |      |                                     |            |                                     |       |                                     |
| Purple/Black  | <input type="checkbox"/>            |                          |       |                                     |      |                                     |      |                                     |        |                          |        |                          |        |                                     |  |                |                          |             |                          |            |                          |       |                          |              |                          |              |                          |              |                          |   |             |                                     |      |                                     |            |                                     |       |                                     |   |          |                                     |       |                          |      |                          |      |                          |        |                          |        |                          |        |                                     |  |                |                          |             |                          |            |                          |       |                          |              |                          |              |                          |              |                          |   |             |                                     |      |                                     |            |                                     |       |                                     |
| Yellow/Black  | <input type="checkbox"/>            |                          |       |                                     |      |                                     |      |                                     |        |                          |        |                          |        |                                     |  |                |                          |             |                          |            |                          |       |                          |              |                          |              |                          |              |                          |   |             |                                     |      |                                     |            |                                     |       |                                     |   |          |                                     |       |                          |      |                          |      |                          |        |                          |        |                          |        |                                     |  |                |                          |             |                          |            |                          |       |                          |              |                          |              |                          |              |                          |   |             |                                     |      |                                     |            |                                     |       |                                     |
| Brown/White   | <input checked="" type="checkbox"/> |                          |       |                                     |      |                                     |      |                                     |        |                          |        |                          |        |                                     |  |                |                          |             |                          |            |                          |       |                          |              |                          |              |                          |              |                          |   |             |                                     |      |                                     |            |                                     |       |                                     |   |          |                                     |       |                          |      |                          |      |                          |        |                          |        |                          |        |                                     |  |                |                          |             |                          |            |                          |       |                          |              |                          |              |                          |              |                          |   |             |                                     |      |                                     |            |                                     |       |                                     |
| Grey  | <input checked="" type="checkbox"/> |                          |       |                                     |      |                                     |      |                                     |        |                          |        |                          |        |                                     |  |                |                          |             |                          |            |                          |       |                          |              |                          |              |                          |              |                          |   |             |                                     |      |                                     |            |                                     |       |                                     |   |          |                                     |       |                          |      |                          |      |                          |        |                          |        |                          |        |                                     |  |                |                          |             |                          |            |                          |       |                          |              |                          |              |                          |              |                          |   |             |                                     |      |                                     |            |                                     |       |                                     |
| Grey/Black  | <input checked="" type="checkbox"/> |                          |       |                                     |      |                                     |      |                                     |        |                          |        |                          |        |                                     |  |                |                          |             |                          |            |                          |       |                          |              |                          |              |                          |              |                          |   |             |                                     |      |                                     |            |                                     |       |                                     |   |          |                                     |       |                          |      |                          |      |                          |        |                          |        |                          |        |                                     |  |                |                          |             |                          |            |                          |       |                          |              |                          |              |                          |              |                          |   |             |                                     |      |                                     |            |                                     |       |                                     |
| Brown   | <input checked="" type="checkbox"/> |                          |       |                                     |      |                                     |      |                                     |        |                          |        |                          |        |                                     |  |                |                          |             |                          |            |                          |       |                          |              |                          |              |                          |              |                          |   |             |                                     |      |                                     |            |                                     |       |                                     |   |          |                                     |       |                          |      |                          |      |                          |        |                          |        |                          |        |                                     |  |                |                          |             |                          |            |                          |       |                          |              |                          |              |                          |              |                          |   |             |                                     |      |                                     |            |                                     |       |                                     |
| Lt. Blue  | <input checked="" type="checkbox"/> |                          |       |                                     |      |                                     |      |                                     |        |                          |        |                          |        |                                     |  |                |                          |             |                          |            |                          |       |                          |              |                          |              |                          |              |                          |   |             |                                     |      |                                     |            |                                     |       |                                     |   |          |                                     |       |                          |      |                          |      |                          |        |                          |        |                          |        |                                     |  |                |                          |             |                          |            |                          |       |                          |              |                          |              |                          |              |                          |   |             |                                     |      |                                     |            |                                     |       |                                     |
| White   | <input type="checkbox"/>            |                          |       |                                     |      |                                     |      |                                     |        |                          |        |                          |        |                                     |  |                |                          |             |                          |            |                          |       |                          |              |                          |              |                          |              |                          |   |             |                                     |      |                                     |            |                                     |       |                                     |   |          |                                     |       |                          |      |                          |      |                          |        |                          |        |                          |        |                                     |  |                |                          |             |                          |            |                          |       |                          |              |                          |              |                          |              |                          |   |             |                                     |      |                                     |            |                                     |       |                                     |
| Pink  | <input type="checkbox"/>            |                          |       |                                     |      |                                     |      |                                     |        |                          |        |                          |        |                                     |  |                |                          |             |                          |            |                          |       |                          |              |                          |              |                          |              |                          |   |             |                                     |      |                                     |            |                                     |       |                                     |   |          |                                     |       |                          |      |                          |      |                          |        |                          |        |                          |        |                                     |  |                |                          |             |                          |            |                          |       |                          |              |                          |              |                          |              |                          |   |             |                                     |      |                                     |            |                                     |       |                                     |
| Blue  | <input type="checkbox"/>            |                          |       |                                     |      |                                     |      |                                     |        |                          |        |                          |        |                                     |  |                |                          |             |                          |            |                          |       |                          |              |                          |              |                          |              |                          |   |             |                                     |      |                                     |            |                                     |       |                                     |   |          |                                     |       |                          |      |                          |      |                          |        |                          |        |                          |        |                                     |  |                |                          |             |                          |            |                          |       |                          |              |                          |              |                          |              |                          |   |             |                                     |      |                                     |            |                                     |       |                                     |
| Orange  | <input type="checkbox"/>            |                          |       |                                     |      |                                     |      |                                     |        |                          |        |                          |        |                                     |  |                |                          |             |                          |            |                          |       |                          |              |                          |              |                          |              |                          |   |             |                                     |      |                                     |            |                                     |       |                                     |   |          |                                     |       |                          |      |                          |      |                          |        |                          |        |                          |        |                                     |  |                |                          |             |                          |            |                          |       |                          |              |                          |              |                          |              |                          |   |             |                                     |      |                                     |            |                                     |       |                                     |
| Purple  | <input type="checkbox"/>            |                          |       |                                     |      |                                     |      |                                     |        |                          |        |                          |        |                                     |  |                |                          |             |                          |            |                          |       |                          |              |                          |              |                          |              |                          |   |             |                                     |      |                                     |            |                                     |       |                                     |   |          |                                     |       |                          |      |                          |      |                          |        |                          |        |                          |        |                                     |  |                |                          |             |                          |            |                          |       |                          |              |                          |              |                          |              |                          |   |             |                                     |      |                                     |            |                                     |       |                                     |
| Yellow  | <input checked="" type="checkbox"/> |                          |       |                                     |      |                                     |      |                                     |        |                          |        |                          |        |                                     |  |                |                          |             |                          |            |                          |       |                          |              |                          |              |                          |              |                          |   |             |                                     |      |                                     |            |                                     |       |                                     |   |          |                                     |       |                          |      |                          |      |                          |        |                          |        |                          |        |                                     |  |                |                          |             |                          |            |                          |       |                          |              |                          |              |                          |              |                          |   |             |                                     |      |                                     |            |                                     |       |                                     |
| Lt. Blue/Black  | <input type="checkbox"/>            |                          |       |                                     |      |                                     |      |                                     |        |                          |        |                          |        |                                     |  |                |                          |             |                          |            |                          |       |                          |              |                          |              |                          |              |                          |   |             |                                     |      |                                     |            |                                     |       |                                     |   |          |                                     |       |                          |      |                          |      |                          |        |                          |        |                          |        |                                     |  |                |                          |             |                          |            |                          |       |                          |              |                          |              |                          |              |                          |   |             |                                     |      |                                     |            |                                     |       |                                     |
| White/Black   | <input type="checkbox"/>            |                          |       |                                     |      |                                     |      |                                     |        |                          |        |                          |        |                                     |  |                |                          |             |                          |            |                          |       |                          |              |                          |              |                          |              |                          |   |             |                                     |      |                                     |            |                                     |       |                                     |   |          |                                     |       |                          |      |                          |      |                          |        |                          |        |                          |        |                                     |  |                |                          |             |                          |            |                          |       |                          |              |                          |              |                          |              |                          |   |             |                                     |      |                                     |            |                                     |       |                                     |
| Pink/Black  | <input type="checkbox"/>            |                          |       |                                     |      |                                     |      |                                     |        |                          |        |                          |        |                                     |  |                |                          |             |                          |            |                          |       |                          |              |                          |              |                          |              |                          |   |             |                                     |      |                                     |            |                                     |       |                                     |   |          |                                     |       |                          |      |                          |      |                          |        |                          |        |                          |        |                                     |  |                |                          |             |                          |            |                          |       |                          |              |                          |              |                          |              |                          |   |             |                                     |      |                                     |            |                                     |       |                                     |
| Green   | <input type="checkbox"/>            |                          |       |                                     |      |                                     |      |                                     |        |                          |        |                          |        |                                     |  |                |                          |             |                          |            |                          |       |                          |              |                          |              |                          |              |                          |   |             |                                     |      |                                     |            |                                     |       |                                     |   |          |                                     |       |                          |      |                          |      |                          |        |                          |        |                          |        |                                     |  |                |                          |             |                          |            |                          |       |                          |              |                          |              |                          |              |                          |   |             |                                     |      |                                     |            |                                     |       |                                     |
| Orange/Black  | <input type="checkbox"/>            |                          |       |                                     |      |                                     |      |                                     |        |                          |        |                          |        |                                     |  |                |                          |             |                          |            |                          |       |                          |              |                          |              |                          |              |                          |   |             |                                     |      |                                     |            |                                     |       |                                     |   |          |                                     |       |                          |      |                          |      |                          |        |                          |        |                          |        |                                     |  |                |                          |             |                          |            |                          |       |                          |              |                          |              |                          |              |                          |   |             |                                     |      |                                     |            |                                     |       |                                     |
| Purple/Black  | <input type="checkbox"/>            |                          |       |                                     |      |                                     |      |                                     |        |                          |        |                          |        |                                     |  |                |                          |             |                          |            |                          |       |                          |              |                          |              |                          |              |                          |   |             |                                     |      |                                     |            |                                     |       |                                     |   |          |                                     |       |                          |      |                          |      |                          |        |                          |        |                          |        |                                     |  |                |                          |             |                          |            |                          |       |                          |              |                          |              |                          |              |                          |   |             |                                     |      |                                     |            |                                     |       |                                     |
| Yellow/Black  | <input type="checkbox"/>            |                          |       |                                     |      |                                     |      |                                     |        |                          |        |                          |        |                                     |  |                |                          |             |                          |            |                          |       |                          |              |                          |              |                          |              |                          |   |             |                                     |      |                                     |            |                                     |       |                                     |   |          |                                     |       |                          |      |                          |      |                          |        |                          |        |                          |        |                                     |  |                |                          |             |                          |            |                          |       |                          |              |                          |              |                          |              |                          |   |             |                                     |      |                                     |            |                                     |       |                                     |
| Brown/White   | <input checked="" type="checkbox"/> |                          |       |                                     |      |                                     |      |                                     |        |                          |        |                          |        |                                     |  |                |                          |             |                          |            |                          |       |                          |              |                          |              |                          |              |                          |   |             |                                     |      |                                     |            |                                     |       |                                     |   |          |                                     |       |                          |      |                          |      |                          |        |                          |        |                          |        |                                     |  |                |                          |             |                          |            |                          |       |                          |              |                          |              |                          |              |                          |   |             |                                     |      |                                     |            |                                     |       |                                     |
| Grey  | <input checked="" type="checkbox"/> |                          |       |                                     |      |                                     |      |                                     |        |                          |        |                          |        |                                     |  |                |                          |             |                          |            |                          |       |                          |              |                          |              |                          |              |                          |   |             |                                     |      |                                     |            |                                     |       |                                     |   |          |                                     |       |                          |      |                          |      |                          |        |                          |        |                          |        |                                     |  |                |                          |             |                          |            |                          |       |                          |              |                          |              |                          |              |                          |   |             |                                     |      |                                     |            |                                     |       |                                     |
| Grey/Black  | <input checked="" type="checkbox"/> |                          |       |                                     |      |                                     |      |                                     |        |                          |        |                          |        |                                     |  |                |                          |             |                          |            |                          |       |                          |              |                          |              |                          |              |                          |   |             |                                     |      |                                     |            |                                     |       |                                     |   |          |                                     |       |                          |      |                          |      |                          |        |                          |        |                          |        |                                     |  |                |                          |             |                          |            |                          |       |                          |              |                          |              |                          |              |                          |   |             |                                     |      |                                     |            |                                     |       |                                     |
| Brown   | <input checked="" type="checkbox"/> |                          |       |                                     |      |                                     |      |                                     |        |                          |        |                          |        |                                     |  |                |                          |             |                          |            |                          |       |                          |              |                          |              |                          |              |                          |   |             |                                     |      |                                     |            |                                     |       |                                     |   |          |                                     |       |                          |      |                          |      |                          |        |                          |        |                          |        |                                     |  |                |                          |             |                          |            |                          |       |                          |              |                          |              |                          |              |                          |   |             |                                     |      |                                     |            |                                     |       |                                     |





## MODULE D'INTERFACE CAN BUS POUR ALARME ET DÉMARREUR À DISTANCE



### CÂBLAGE / GUIDE DE CONNEXION

Voir SCHÉMA DE BRANCHEMENT

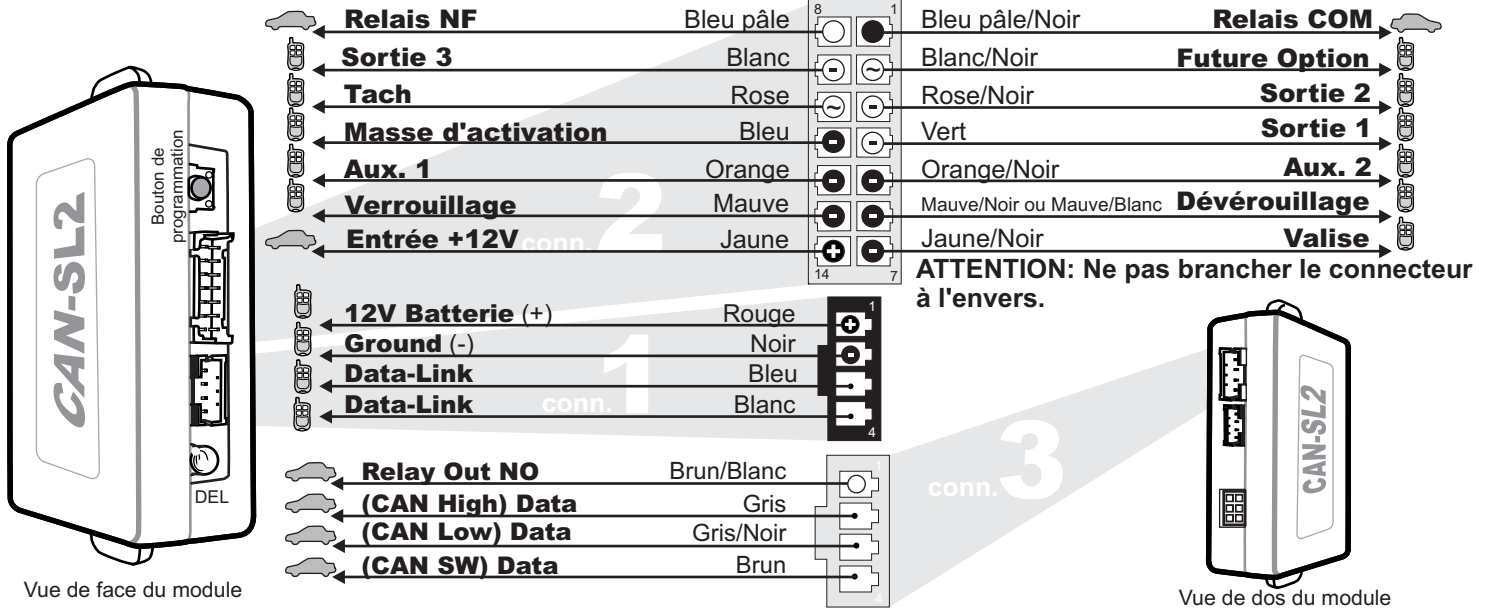

Vue de face du module

Vue de dos du module

Branchement du filage au démarreur à distance/Alarme Branchement du filage au véhicule  SORTIE  ENTRÉE

### COMMENCEZ ICI

## INSTRUCTIONS D'INSTALLATION ET DE PROGRAMMATION

1 Effectuez les connexions du CAN-SL2 au véhicule:

**1.A** **Connecteur 1 (Noir):**  
Déterminez le type d'installation (Data-Link ou non Data-Link)  
Pour l'installation DATA-LINK assurez vous de la présence du connecteur DATA-LINK sur le démarreur. (Voir INSTALLATION AVEC DATA-LINK (P.4)).  
Pour installation non Data-Link voir INSTALLATION SANS DATA-LINK (P.4).

**1.B** **Connecteur 2 (Blanc):**  
Déterminez le type de branchement selon votre véhicule (Voir GUIDE DES VOITURES, P.2-3)

**1.C** **Connecteur 3 (Blanc, situé au dos du module):**  
Déterminez le type de branchement selon votre véhicule (Voir GUIDE DES VOITURES, P.2-3)

**2** Maintenez le bouton de programmation enfoncé en insérant le connecteur 1 dans le CAN-SL2.  
Le DEL s'allume pour indiquer le début de la programmation, relâchez le bouton de programmation.

**3** Branchez le connecteur 2 (CONN. 2)

**3** ATTENTION: Ne pas brancher le connecteur à l'envers.

**4** Branchez le connecteur 3 (CONN. 3)

**5** Tournez la clef en position ignition.

**6** Lorsque le DEL clignote rapidement, tournez la clef en position OFF. (Sauf véhicules GMC: démarrez le véhicule).

**6** Le DEL s'éteint pour indiquer que le module est programmé.

(\* Sauf pour les véhicules Chrysler, Dodge, Jeep, poursuivre à l'étape 7)

### \* Chrysler/Dodge/Jeep

**7** Le DEL clignotera jusqu'à ce que vous pressiez le bouton Verrouillage (Lock) de la télécommande d'origine du véhicule.  
Le DEL s'éteint pour indiquer que le module est programmé.

## INFORMATIONS / SUPPORT TECHNIQUE

Ni le fabricant, ni le distributeur ne se considèrent responsables des dommages causés ou ayant pu être causés, indirectement ou directement, par ce module, excepté le remplacement de ce module en cas de défectuosité de fabrication. Ce module doit être installé par un technicien qualifié. Ce guide d'instruction peut faire l'objet de changement sans préavis. Consultez le [www.ifar.ca](http://www.ifar.ca) pour voir la plus récente version.

**Support Technique:**  
TEL: 514-255-HELP (4357)  
FAX: 514-255-1367  
Web: [www.ifar.ca](http://www.ifar.ca)

