

# EVO-ALL

Guide #3318

Ford / JAGUAR / LINCOLN / MAZDA / MERCURY

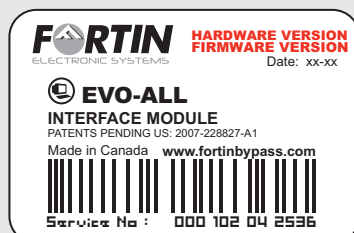
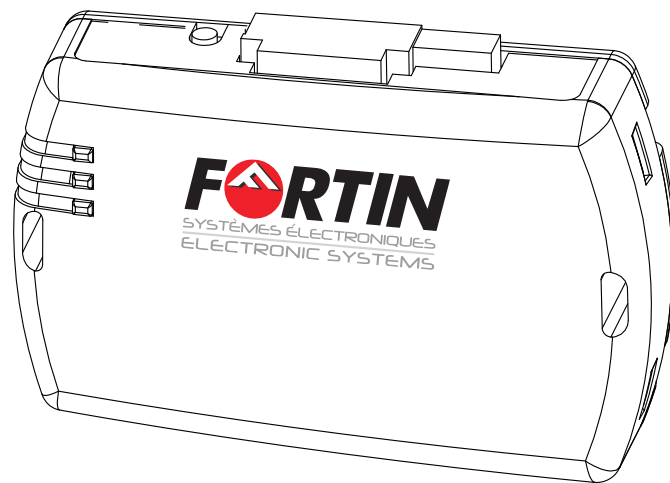

Module label | Étiquette sur le module

### **Notice:** Updated Firmware and Installation Guides

**Updated firmware and installation guides** are posted on our web site on a regular basis. We recommend that you update this module to the latest firmware and download the latest installation guide(s) prior to the installation of this product.

**Des mises à jour du Firmware (microprogramme) et des guides d'installation** sont mises en ligne régulièrement. Vérifiez que vous avez bien la dernière version logiciel et le dernier guide d'installation avant l'installation de ce produit.



### **TECH SUPPORT**

Tél: 514-255-HELP (4357)  
1-877-336-7797



### **ADDENDUM GUIDE**

Rev : 20110602

**www.fortinbypass.com**

WEB UPDATE | MISE À JOUR INTERNET



# WIRE LEGEND | LEGENDE

Input | Entrée    Output | Sortie

Connection always **required**  
Branchement toujours **requis**

Connection **not required** with Data-link  
Branchement **non requis** avec Data-Link

Connect to vehicle  
Branchement au véhicule

Connect to Remote-Starter/Alarm  
Branchement au démarreur à distance/Alarme

**NOTE:**  
All possible functions are summarized in each configuration, however some functions may not be supported on all vehicles. Refer to the VEHICLE FIT GUIDE to determine the supported functions for a specific vehicle.  
*Toutes les fonctions possibles sont écrites dans chaque configuration, toutefois elles ne sont pas toutes supportées par tous les véhicules.. Voir le GUIDE DES VÉHICULES pour déterminer les fonctions supportées sur chaque véhicule.*

## DESCRIPTION

### 20 PIN CONNECTOR: MAIN HARNESS | HARNAIS PRINCIPAL (WHITE|BLANC)

Foot Brake   Frein (pied) Signal	Black   Noir	Yellow   Jaune	See configuration
Tachometer	Pink   Rose	Purple   Mauve	Lock   Verrouille
Trunk Release   Valise	Yellow/Black   Jaune/Noir	Purple/White   Mauve/Blanc	Unlock   Déverrouille
Hand Brake   Frein à Main Signal	Brown/White   Brun/Blanc	Green   Vert	Door Status   Statuts Portes
Hood Status   Capot Statuts	Pink/Black   Rose/Noir	White   Blanc	Trunk Status   Statuts Valise
See configuration	Purple/Yellow   Mauve/Jaune	Orange	AUX 1
See configuration	Green/White   Vert/Blanc	Orange/Black   Orange/Noir	AUX 2
See configuration	Green/Red   Vert/Rouge	Dk. Blue   Bleu foncé	GWR (Ground While Running)
See configuration	White/Black   Blanc/Noir	Red/Blue   Rouge/Bleu	See configuration
See configuration	Lt. Blue   Bleu Pâle	Lt. Blue/Black   Bleu Pâle/Noir	See configuration

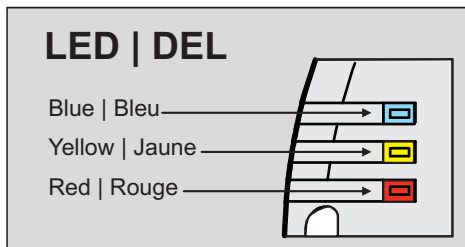

### 4 PIN CONNECTOR: DATA-LINK (BLACK | NOIR) SEE PAGE 3 | VOIR PAGE 3

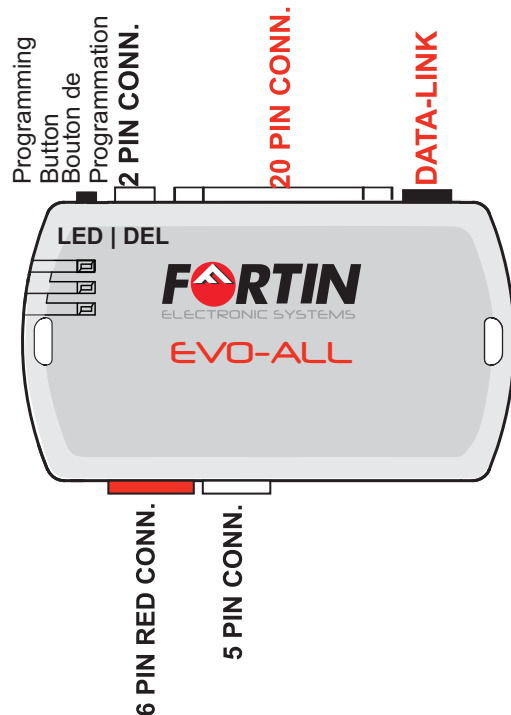
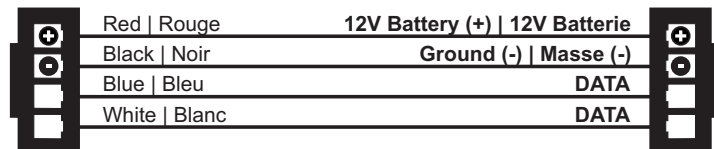

### 5 PIN CONNECTOR: CAN-BUS (WHITE | BLANC)

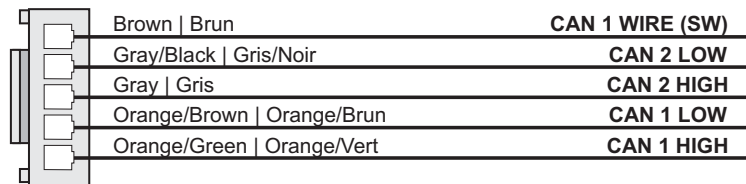

### 6 PIN CONNECTOR: RELAY | RELAIS (RED | ROUGE)



### 2 PIN CONNECTOR: TB CONTROL (WHITE | BLANC)

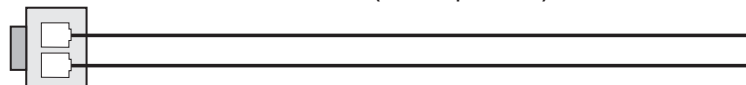

# INSTALLATION PROCEDURE

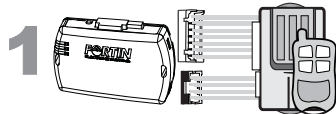

**1 Determine if the remote-starter or alarm system supports 2-way Data-Link.**

**Déterminez si le démarreur à distance ou système d'alarme est compatible en Data-Link 2-voies.**

## WITH DATA-LINK AVEC DATA-LINK

In order to utilize this type of connection the remote-starter or alarm-system must be compatible with the **Fortin Data-link protocol**. Consult the installation guide or visit [www.fortinbypass.com/datalink/](http://www.fortinbypass.com/datalink/) for more information.

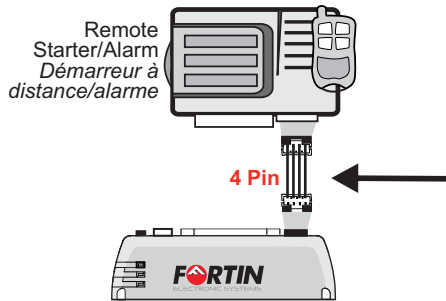

Le démarreur à distance ou le système d'alarme doit être compatible avec le **protocole Data-link Fortin** pour ces branchements. Consultez le guide d'installation du démarreur à distance ou du système d'alarme ou visitez le [www.fortinbypass.com/datalink/](http://www.fortinbypass.com/datalink/) pour plus d'informations.

## WITH OUT DATA-LINK SANS DATA-LINK

For all other remote-starters or alarm-systems perform the following connections.

Pour tout autres types de démarreurs à distance ou d'alarme, effectuez les branchements suivants.

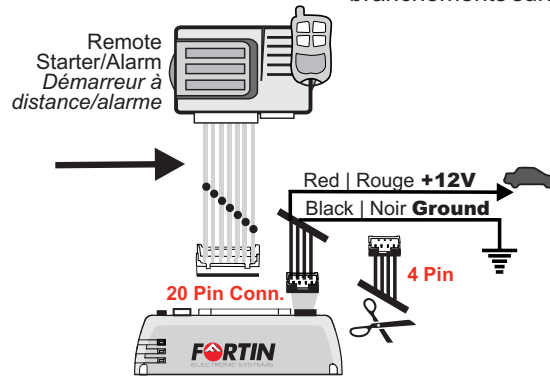

- 1 Cut off one plug of the 4 Pin Data-Link connector
- 2 Connect the Red wire to +12V
- 3 Connect the Black wire to Ground

- 1 **Coupez** l'extrémité du connecteur 4 pins Data-Link
- 2 **Connectez** le fil rouge au 12V
- 3 **Connectez** le fil noir à la masse du véhicule.



**2 Make the connections :**

**Faire les branchements :**



**20 Pin Connector (White):**  
Make the connections associated with the vehicle from the VEHICLE FIT GUIDE.

**20 Pins Connecteur (Blanc):**  
Effectuez les branchements associés au véhicule dans le GUIDE DES VÉHICULES.



**5 Pin Connector CAN (White):**  
Make the connections (if required)

**5 Pins Connecteur CAN (Blanc):**  
Effectuez les branchements.(Si nécessaire)



**6 Pin Connector RELAY (Red):**  
Make the connections (if required)

**6 Pins Connecteur RELAI (Rouge):**  
Effectuez les branchements.(Si nécessaire)



**2 Pin Connector (White):**  
Make the connections (if required)

**2 Pins Connecteur (Blanc):**  
Effectuez les branchements.(Si nécessaire)

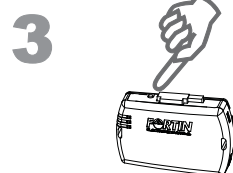

## PROGRAMMING PROCEDURE

Follow the programming procedure on page 4.

## PROCÉDURE DE PROGRAMMATION

Suivez la procédure de programmation à la page 4.



**VEHICLE FIT GUIDE | GUIDE DES VÉHICULES**

VEHICLE   VEHICULES	YEARS ANNÉES	Connection	Programming	Lock	Unlock	Arm	Disarm	Hatch (open)	Trunk (open)	Sliding Door	Window Roll Down	Gas Door	RAP Disable	Parking Light	Memory Driver	Tachometer	Heated Seats	Heated Mirrors	Rear Defrost	Door Status	Trunk Status	Hood Status	Hand-Brake Status	Foot-Brake Status	Transponder Bypass	PK3, Passlock	Key Control	Activate OEM Remote Start	Push-to-Start Control	Legend
MKT	2010	5	5	•	•	•	•																							
MKX	2007-2010	1F	1	2 Keys req.   2 clés requises																										
MKZ	2007-2010	3	4	•	•	•	•													•	•		•	•						
Navigator	1998-2001	1A	1																											
	2002-2010	1B	1	2 Keys req.   2 clés requises																										
Town Car	1997-2002	1A	1																											
	2003-2004	1C	1	2 Keys req.   2 clés requises																										
	2005-2010	1F	1	2 Keys req.   2 clés requises																										
Zephyr	2006	1F	1	2 Keys req.   2 clés requises																										
<b>MAZDA</b>				<b>A</b>	<b>B</b>	<b>C</b>	<b>D</b>	<b>E</b>	<b>F</b>	<b>G</b>	<b>H</b>	<b>I</b>	<b>J</b>	<b>K</b>	<b>L</b>	<b>M</b>	<b>N</b>	<b>P</b>	<b>Q</b>	<b>R</b>	<b>S</b>	<b>T</b>	<b>U</b>	<b>V</b>	<b>W</b>	<b>X</b>	<b>Y</b>	<b>Z</b>	<b>ZA</b>	<b>ZB</b>
2	2011	1D	1	2 Keys req.   2 clés requises																										
3 - Axela	2004-2010	1D	1	2 Keys req.   2 clés requises																										
	Smart Keyless 2010	1E	2	Scan tool required   requis																										
5	2006-2010	1D	1	2 Keys req.   2 clés requises																										
6 - Atenza	2003-2010	1D	1	2 Keys req.   2 clés requises																										
	Smart Keyless 2009-2010	1E	2	Scan tool required   requis																										
B-Series	1999-2001	1A	1																											
	2002-2009	1C	1	2 Keys req.   2 clés requises																										
CX-7	2007-2010	1D	1	2 Keys req.   2 clés requises																										
CX-9	2007-2010	1D	1	2 Keys req.   2 clés requises																										
MPV	2000-2006	2	3																											
MX-5 - Miata	2002-2005	2	3																											
	2006-2010	1F	1	2 Keys req.   2 clés requises																										
RX-8	2003-2010	1D	1	2 Keys req.   2 clés requises																										
Tribute	2001-2010	1B	1	2 Keys req.   2 clés requises																										
<b>MERCURY</b>				<b>A</b>	<b>B</b>	<b>C</b>	<b>D</b>	<b>E</b>	<b>F</b>	<b>G</b>	<b>H</b>	<b>I</b>	<b>J</b>	<b>K</b>	<b>L</b>	<b>M</b>	<b>N</b>	<b>P</b>	<b>Q</b>	<b>R</b>	<b>S</b>	<b>T</b>	<b>U</b>	<b>V</b>	<b>W</b>	<b>X</b>	<b>Y</b>	<b>Z</b>	<b>ZA</b>	<b>ZB</b>
Cougar	1999-2002	1B	1																											
Grand Marquis	1998-2002	1A	1																											
	2003-2004	1C	1	2 Keys req.   2 clés requises																										
	2005-2010	1F	1	2 Keys req.   2 clés requises																										
Marauder	2003-2004	1C	1	2 Keys req.   2 clés requises																										
Mariner	2005-2010	1B	1	2 Keys req.   2 clés requises																										
Mariner Hyb	2005-2010	1B	1	2 Keys req.   2 clés requises																										
Milan	2006-2010	1F	1	2 Keys req.   2 clés requises																										
Montego	2005-2007	1F	1	2 Keys req.   2 clés requises																										
Monterev	2004-2007	1C	1	2 Keys req.   2 clés requises																										
Mountaineer	1998-2000	1A	1																											
	2001	1A	1	2 Keys req.   2 clés requises																										
	2002-2005	1B	1	2 Keys req.   2 clés requises																										
	2006-2010	1F	1	2 Keys req.   2 clés requises																										
Mystique	1998-2000	1B	1																											
Sable	1996-1999	1A	1																											
	2000-2009	1A	1	2 Keys req.   2 clés requises																										

**LEGEND | LÉGENDE**

- 1 **TB-GM2\*** for transponder bypass | pour contournement du transpondeur
- 2 **TB-KIA1\*** for transponder bypass | pour contournement du transpondeur
- 3 **TB-KIA2\*** for transponder bypass | pour contournement du transpondeur
- 4 **TB-MITS2\*** for transponder bypass | pour contournement du transpondeur
- 5 Heated seats will only turn ON (low power) if the engine temperature is below 0°C (32°F) when remote started. | Les sièges chauffants s'allument à faible intensité SEULEMENT si la température du moteur est sous 0°C (32°F) au
- 6 **INT-BMW1\*** for remote car starter | Pour démarreur à distance
- 7 **TB-SUBARU1 or 2\*** for transponder bypass | pour contournement du
- 8 A special diagram is required for Remote car starter | Un diagramme spécial est requis pour démarreur à distance : see www.fortinbypass.com
- 9 **INSET\*** for remote car starter | Pour démarreur à distance
- 10 **EVO-ALL** version hardware 3 required | requière version hardware 3

**Key Control** : (Contrôle de la Clé) KEY REQUIRED. Transponder bypass by wrapping of factory key. CLÉ REQUISE. The module activates the relay on connector 2 (White wire) during remote start. Contournement du transpondeur par enroulement de la clé d'origine. Le module active le relais du connecteur 2 pin Blanc lors du démarrage à distance.

**Activate OEM Remote Start** : (Active Démarreur d'origine) The module activates the factory remote starter if the vehicle has one equipped. Le module active le démarreur à distance d'origine lorsque le véhicule en est équipé.

**Push-to-Start Control** : (Contrôl Bouton Démarreur) For Push-to-Start vehicles, the module activates the push button to allow seamless takeover by the user. Pour les véhicules équipés de bouton Push-to-Start, le module actionne le bouton dans le but d'éviter à l'utilisateur de le faire avant de conduire le véhicule.

**CONNECTION 1**

JAGUAR / LINCOLN / MAZDA / MERCURY / FORD

**GO PROGRAM: 1**

**PUSH TO START GO PROGRAM: 2**

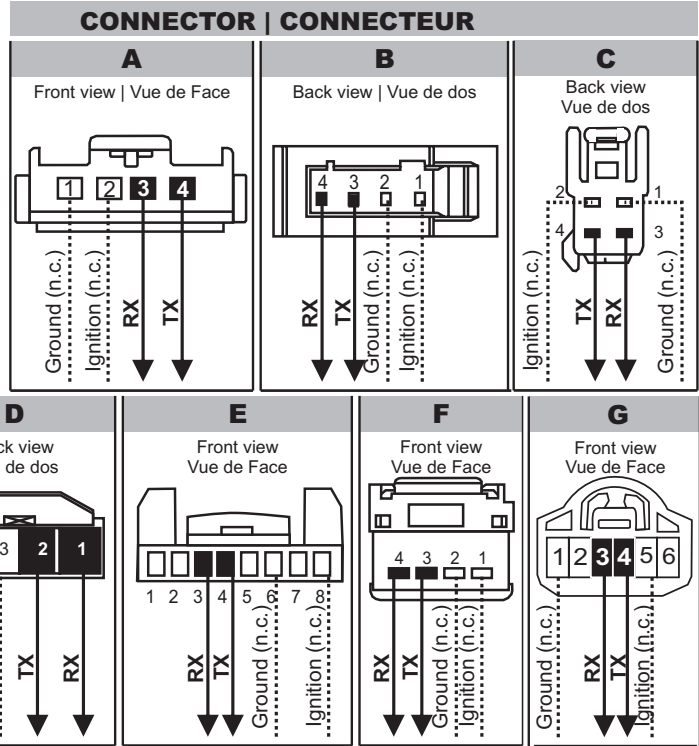
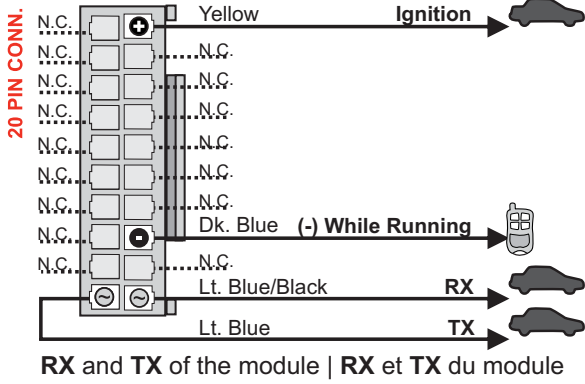

**Ignition barrel  
Barrillet de l'ignition**

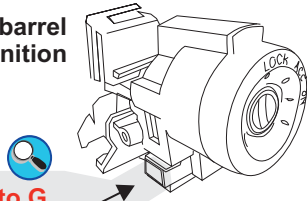

**Connector A to G  
Connecteur A à G**

**CONNECTION 2**

MAZDA MIATA / MPV

**GO PROGRAM: 3**

MAZDA	Data Pin 5	Ignition Pin 7
MPV 2000-2003	Blue/White	Black/White
MPV 2004-2006	Blue/White	Black/White
Miata 2001-2004	Red/Black	Black/White

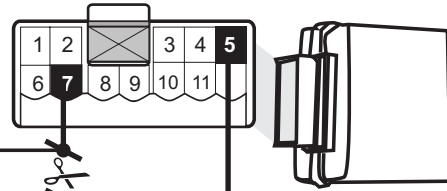
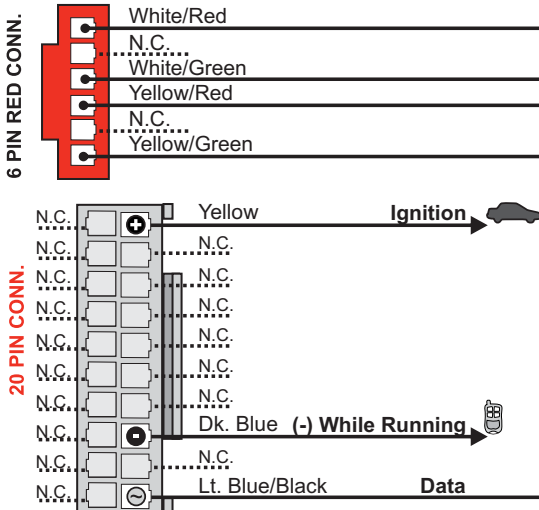

**Immobilizer module:**  
Near steering column.  
**Module d'immobilisation:**  
Localisé près de la colonne de direction

**CONNECTION 3**

**GO PROGRAM: 4**

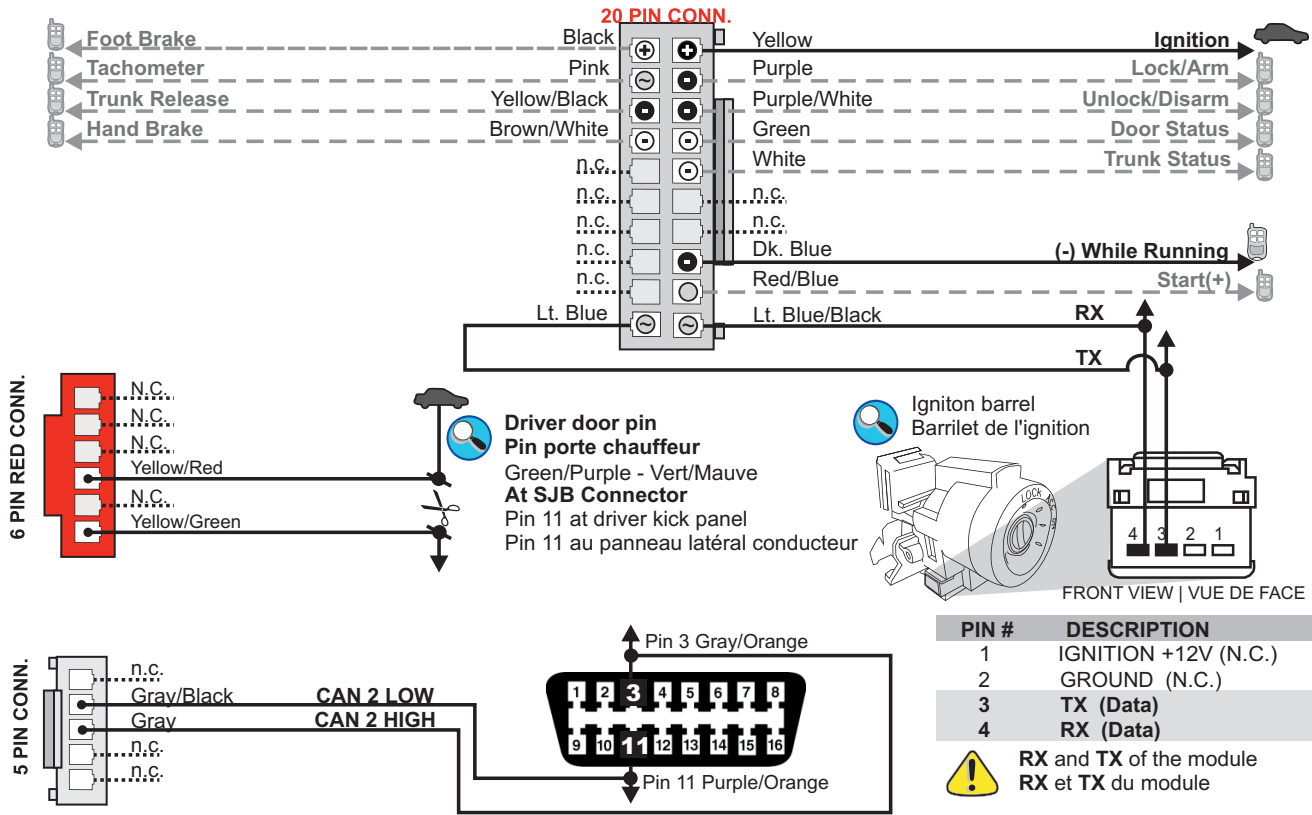



CONNECTION 4A

For automatic transmission see CONNECTION 4B

GO PROGRAM: 5

**Fiesta**  
MANUAL TRANSMISSION  
TRANSMISSION MANUEL

**ADDENDUM - SUGGESTED WIRING CONFIGURATION**  
**SCHEMA DE BRANCHEMENT SUGGERÉ**



**Parts required**

- 1x 10A Fuse
- 1x Relay
- 3x 1A Diode
- 1x INSET (Sold separately)

**Pièces requises**

- 1x fusible 10A
- 1x Relais
- 3x Diodes 1A
- 1x INSET (Vendu séparément)

**EVO-ALL Firmware version :2.12 and newer | et plus**

Functional if equipped | Fonctionnelle si le véhicule en est équipé.

VEHICLES   VEHICULES	YEARS ANNÉES	Lock	Unlock	Arm	Disarm	Hatch (open)	Trunk (open)	Sliding Door	Window Roll Down	Gas Door	RAP Disable	Parking Lights	Memory Driver	Tachometer	Defrost	Heated Seats	Heated Mirrors	Rear Defrost	Door Status	Trunk Status	Hood Status	Hand-Brake Status	Foot-Brake Status	Transponder Bypass	PK3, Passlock	Key Control	Activate OEM Remote Start	Push-to-Start Control	SEE LEGEND
Ford	Fiesta	A	B	C	D	E	F	G	H	I	J	K	L	M	N	O	P	Q	R	S	T	U	V	W	X	Y	Z	ZA	ZB
Fiesta	Push-to-Start	2011	.	.	.	.	.	.	.	.	.	.	.	.	.	.	.	.	.	.	.	.	.	.	.	.	.	.	.

**1 Driver Kick panel**  
**Panneau Latéral côté chauffeur**

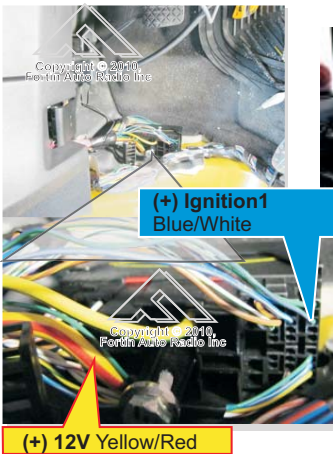

**2 At Clutch Switch 1**  
**Au commutateur d'embrayage 1**

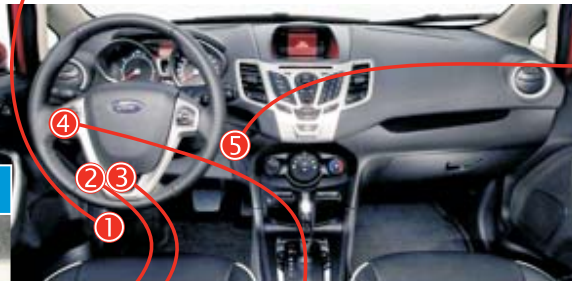
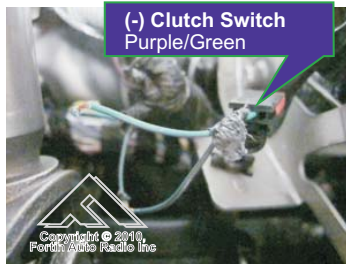

**3 At Clutch Switch 2**  
**Au commutateur d'embrayage 2**

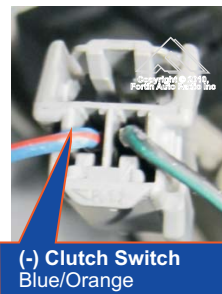

**4 At Parking Light harness**  
**Au harnais des lumières de stationnement**

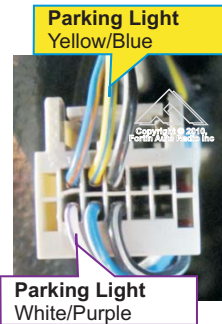

**5 At Push to Start Button**  
**Au bouton démarrage**

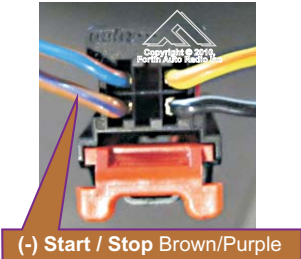

**6 OBDII**

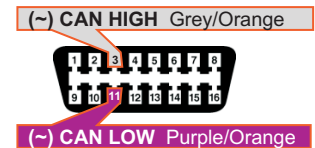

Connection always **required**  
Branchement toujours **requis**

Connection **not required** with Data-link  
Branchement **non requis** avec Data-Link

Connect to vehicle  
Branchement au véhicule

Connect to Remote-Starter/Alarm  
Branchement au démarreur à distance/Alarme

**INSTALLATION WITH DATA-LINK**  
**INSTALLATION AVEC DATA-LINK**

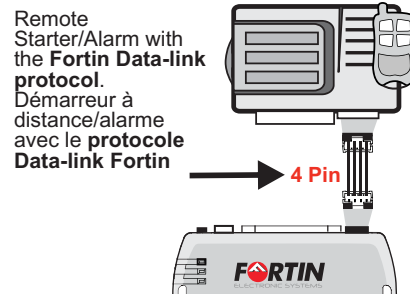

**INSTALLATION WITHOUT DATA-LINK**  
**INSTALLATION SANS DATA-LINK**

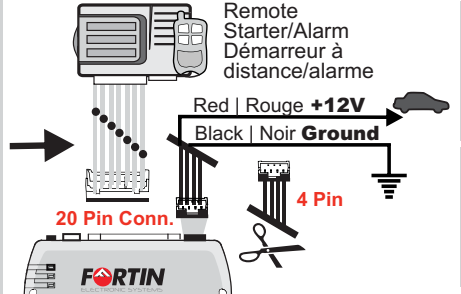

- 1 Cut off one plug of the 4 Pin Data-Link connector
  - 2 Connect the Red wire to +12V
  - 3 Connect the Black wire to Ground
- 1 Coupez l'extrémité du connecteur 4 pins Data-Link
  - 2 Connectez le fil rouge au 12V
  - 3 Connectez le fil noir à la masse du véhicule.



**FIESTA MANUAL TRANSMISSION CONTINUED | SUITE**

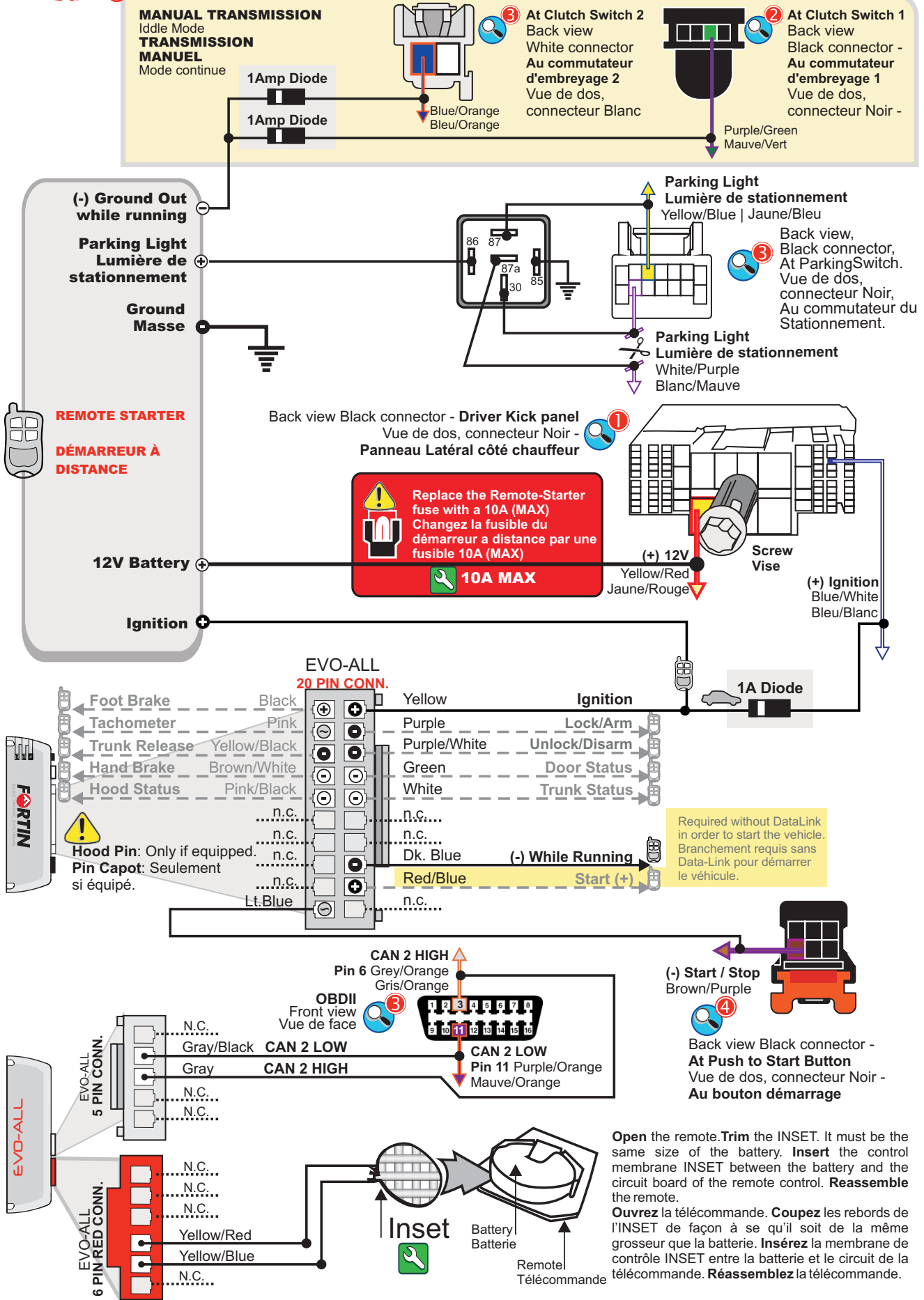

**CONNECTION 4B**

For automatic transmission see **CONNECTION 4A**

**GO PROGRAM: 5**

# Fiesta

AUTOMATIC TRANSMISSION  
TRANSMISSION AUTOMATIQUE

## ADDENDUM - SUGGESTED WIRING CONFIGURATION SCHÉMA DE BRANCHEMENT SUGGÉRÉ



**Parts required**

- 1x 10A Fuse
- 1x Relay
- 1x 1A Diode
- 1x INSET (Sold separately)

**Pièces requises**

- 1x fusible 10A
- 1x Relais
- 1x Diodes 1A
- 1x INSET (Vendu séparément)

**EVO-ALL Firmware version :2.12 and newer | et plus**

Functional if equipped | Fonctionnelle si le véhicule en est équipé.

VEHICLES   VEHICULES	YEARS ANNÉES	Lock	Unlock	Arm	Disarm	Hatch (open)	Trunk (open)	Sliding Door	Window Roll Down	Gas Door	RAP Disable	Parking Lights	Memory Driver	Tachometer	Defrost	Heated Seats	Heated Mirrors	Rear Defrost	Door Status	Trunk Status	Hood Status	Hand-Brake Status	Foot-Brake Status	Transponder Bypass	PK3, Passlock	Key Control	Activate OEM Remote Start	Push-to-Start Control	SEE LEGEND
<b>Ford</b>		A	B	C	D	E	F	G	H	I	J	K	L	M	N	O	P	Q	R	S	T	U	V	W	X	Y	Z	ZA	ZB
Fiesta	2011	.	.	.	.	.	.	.	.	.	.	.	.	.	.	.	.	.	.	.	.	.	.	.	.	.	.	.	.

Hood Status: If equipped with OEM hood pin

**1 Driver Kick panel  
Panneau Latéral côté chauffeur**

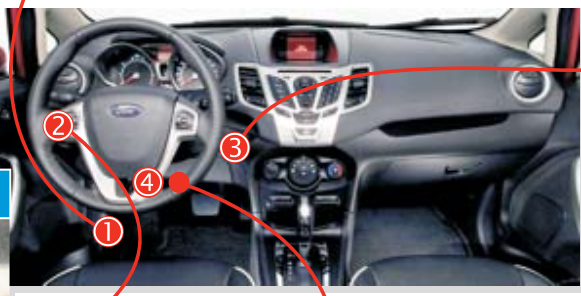
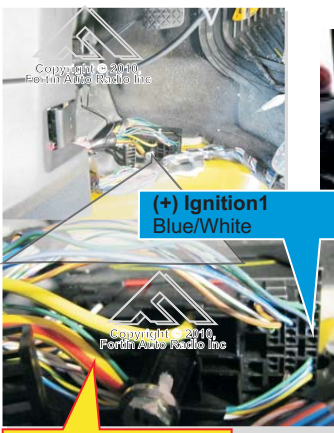

**5 At Push to Start Button  
Au bouton démarrage**



(+) 12V Yellow/Red

**2 At Parking Light harness  
Au harnais des lumières de stationnement**



**5 6 At brake switch  
Au commutateur de frein**

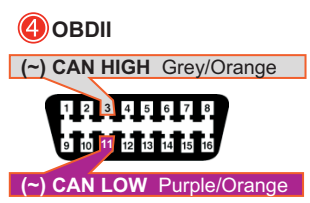
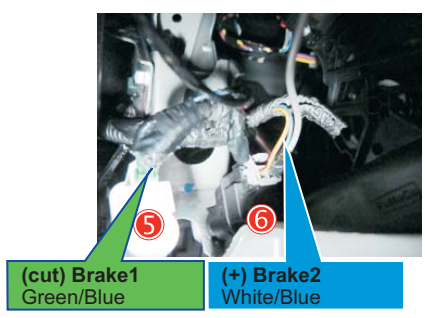

	Input Entrée		Connection always <b>required</b> Branchement toujours <b>requis</b>		Connect to vehicle Branchement au véhicule
	Output Sortie		Connection <b>not required</b> with Data-link Branchement <b>non requis</b> avec Data-Link		Connect to Remote-Starter/Alarm Branchement au démarreur à distance/Alarme

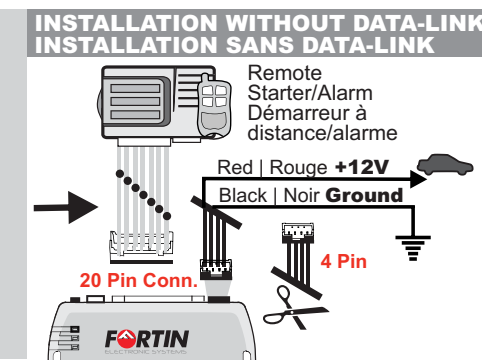
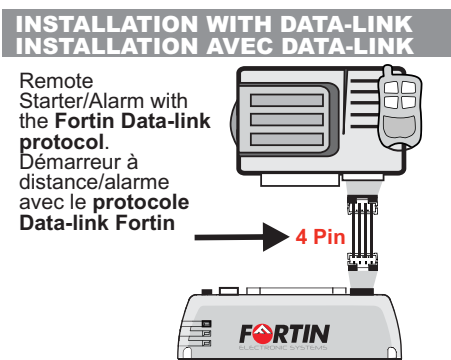

- 1 Cut off one plug of the 4 Pin Data-Link connector
  - 2 Connect the Red wire to +12V
  - 3 Connect the Black wire to Ground
- 1 Coupez l'extrémité du connecteur 4 pins Data-Link
  - 2 Connectez le fil rouge au 12V
  - 3 Connectez le fil noir à la masse du véhicule.





**CONNECTION 5**

**GO PROGRAM: 5**

**MKT**

**ADDENDUM - SUGGESTED WIRING CONFIGURATION  
SCHÉMA DE BRANCHEMENT SUGGÉRÉ**



**Parts required**

- 1x 10A Fuse
- 4x 1A Diode
- 1x Relay
- 1x Ring (Sold separately)

**Pièces requises**

- 1x fusible 10A
- 4x Diodes 1A
- 1x Relais
- 1x Anneau (Vendu séparément)

**EVO-ALL version :2.0 and more | et plus**

Functional if equipped | Fonctionnelle si le véhicule en est équipé.

VEHICLES   VÉHICULES	YEARS ANNÉES	Lock	Unlock	Arm	Disarm	Hatch (open)	Trunk (open)	Sliding Door	Window Roll Down	Gas Door	RAP Disable	Parking Lights	Memory Driver	Tachometer	Defrost	Heated Seats	Heated Mirrors	Rear Defrost	Door Status	Trunk Status	Hood Status	Hand-Brake Status	Foot-Brake Status	Transponder Bypass	PK3, Passlock	Key Control	Activate OEM Remote	Start	Push-to-Start Control	SEE LEGEND
LINCOLN		A	B	C	D	E	F	G	H	I	J	K	L	M	N	O	P	Q	R	S	T	U	V	W	X	Y	Z	ZA	ZB	
MKT	Smart-Key	2010-2011	•	•	•	•																								

**1 At Parking Light harness  
Au harnais des lumières de stationnement**

**(-) Parking Light White/Purple**



**(-) Parking Light Grey**

**2 Trunk Connector  
Connecteur de Valise**

**(-) Trunk Grey/Yellow**



**3 BCM**

**(+) Accessory Purple/Green**

**(+) 12V White/Red**

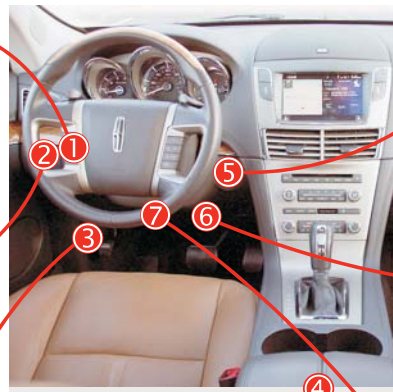
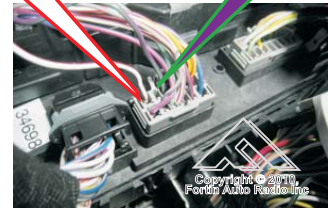

**4 Transponder Antenna  
Antenne Transpondeur**



**5 At Push-to-start button  
Au bouton Push-to-Start**

**(-) Start/Stop Yellow/Red**

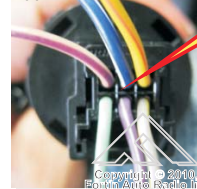

**6 At Brake Switch  
Au commutateur de frein**

**(+) Brake Purple/White**

**(+) 12V Tan/Red**



**7 OBDII**

**CAN 2 HIGH Grey/Orange**



**CAN 2 LOW Purple/Orange**



Connection always **required**  
Branchement toujours **requis**

Connection **not required** with Data-link  
Branchement **non requis** avec Data-Link

Connect to vehicle  
Branchement au véhicule

Connect to Remote-Starter/Alarm  
Branchement au démarreur à distance/Alarme

**INSTALLATION WITH DATA-LINK  
INSTALLATION AVEC DATA-LINK**

Remote Starter/Alarm with the Fortin Data-link protocol.  
Démarreur à distance/alarme avec le protocole Data-link Fortin

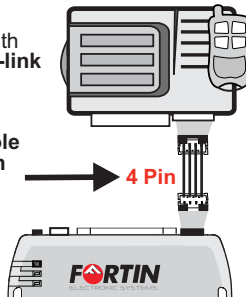

**INSTALLATION WITHOUT DATA-LINK  
INSTALLATION SANS DATA-LINK**

Remote Starter/Alarm Démarreur à distance/alarme

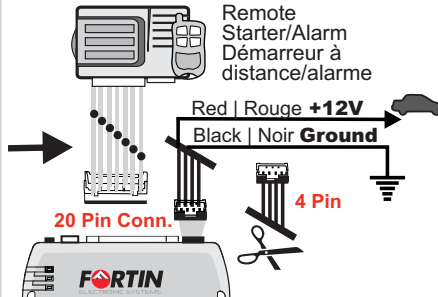

- 1 Cut off one plug of the 4 Pin Data-Link connector
- 2 Connect the Red wire to +12V
- 3 Connect the Black wire to Ground

- 1 Coupez l'extrémité du connecteur 4 pins Data-Link
- 2 Connectez le fil rouge au 12V
- 3 Connectez le fil noir à la masse du véhicule.

MKT CONTINUED | SUITE

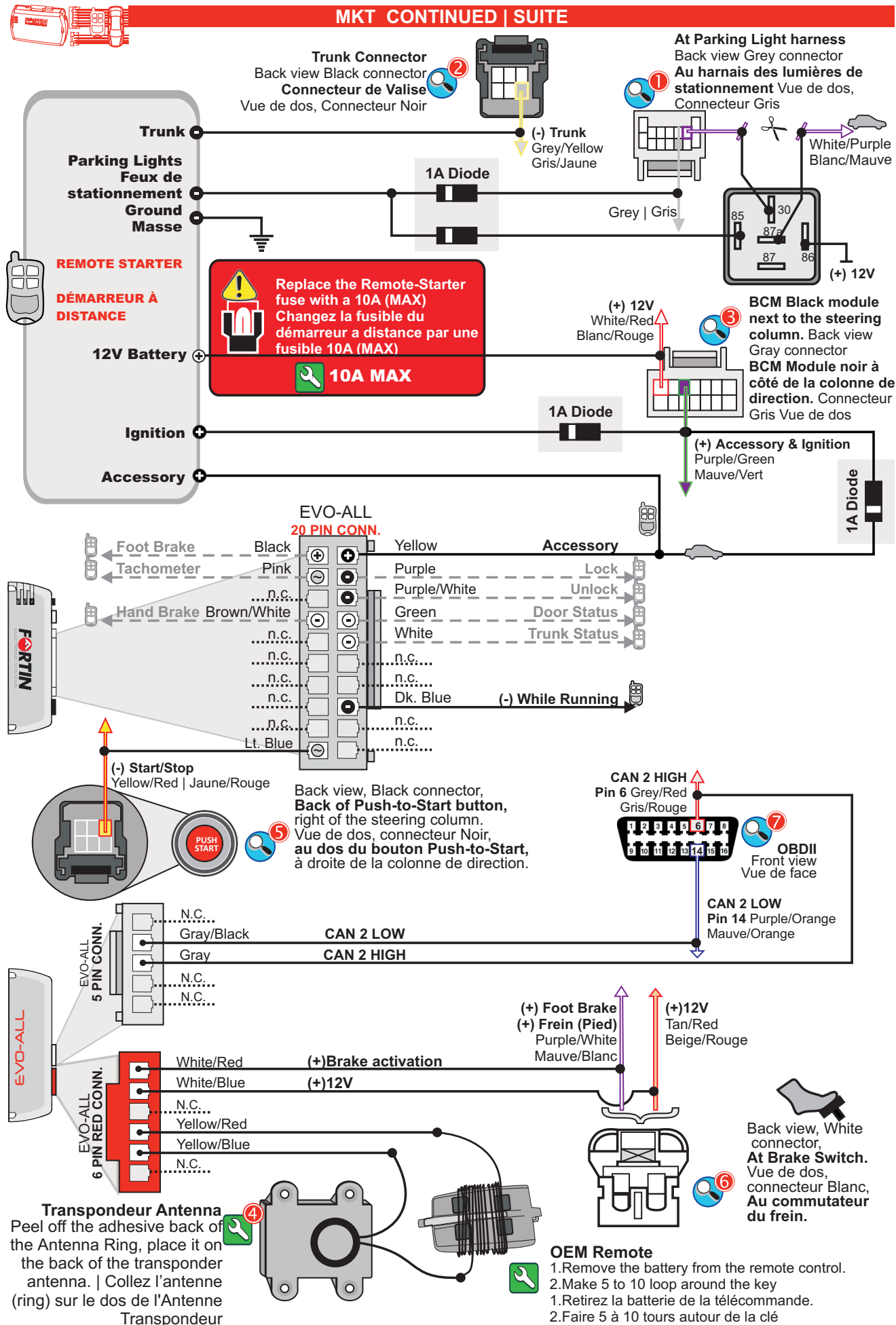

**PROGRAM. 1 FORD / JAGUAR / MAZDA / LINCOLN / MERCURY**

Vehicle equipped with SMART KEY  
Véhicule équipé d'une clé INTELLIGENTE



**Remove** all keys from key remote cards.  
**Retirez** les 2 clés des télécommandes. (cartes).



**Keep** all cards at least 3 meters (10 feet) away from the vehicle to proceed.  
**Éloignez** les télécommandes du véhicule (10 pieds / 3 mètres minimum) pour procéder à la programmation.

**1**



**Press and hold** the programming button:

**Appuyez et maintenez enfoncé** le bouton de programmation:



**Insert** the required remaining connectors:  
20 pin (White), 5 pin (White), 6 pin (Red), 2 pin (White).

**Insérez** les connecteurs requis restants:  
20 pins (Blanc), 2 pins (Blanc), 5 pins (Blanc), 6 pins (Rouge)

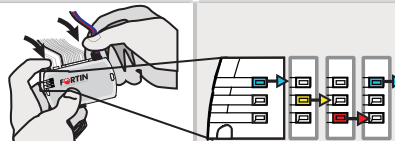

**Insert** the 4 Pin (Data-Link) connector.

**Insérez** le connecteur 4 pins (Data-Link).

The LED will alternate between BLUE, YELLOW and RED flashes.

Les DELS alternent entre un flash BLEU, JAUNE et ROUGE.

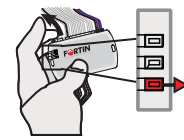

**Release** the programming button when the LED is RED.

**Relâchez** le bouton de programmation quand la DEL est ROUGE.

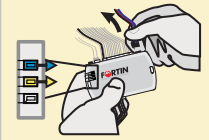

If the LED is not solid RED disconnect the 4 Pin connector (Data-Link) and go back to beginning of step 1. Si le DEL n'est pas ROUGE solide débranchez le connecteur 4 pins (Data-Link) et allez au début de l'étape 1.



Refer to the VEHICLE FIT GUIDE to determine if two keys are required. Voir le GUIDE DES VÉHICULES pour déterminer si 2 clés sont nécessaires.

**2**



**Turn** the first key to the ON/RUN position.

**Tournez** la clé #1 à la position ON/RUN.



**Wait** 3 seconds or until the security light turns OFF.

**Attendre** 3 secondes ou jusqu'à ce que la lumière sécurité du tableau de bord s'éteigne.



**Turn** the key to the OFF position and remove the first key.

**Tournez** la clé à la position ARRÊT (OFF) et retirez la clé du barillet.



**Wait** 3 seconds.

**Attendre** 3 secondes.



**Turn** the second key to the ON/RUN position. If only 1 key is required reuse the first key. **Tournez** la seconde clé à la position ON/RUN. Si une (1) seule clé est requise réutilisez la 1ère clé.

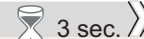

**Wait** 3 seconds or until the security light turns OFF.

**Attendre** 3 secondes ou jusqu'à ce que la lumière sécurité du bord s'éteigne.

**3**

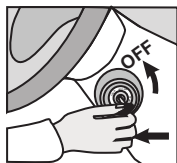

**Turn** the key to the OFF position and remove the key.

**Tournez** la clé à la position ARRÊT (OFF) et retirez la clé du barillet.



**Activate** the remote starter. **Actionnez** le démarreur à distance.

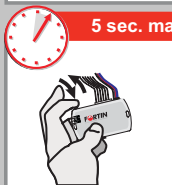

**Press and release** the programming button.

**Pesez et relâchez** le bouton de programmation.

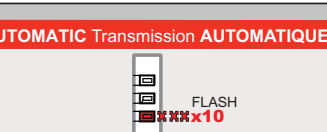

The RED LED will flash rapidly ten (10) times. La DEL ROUGE clignotera dix (10) fois rapidement.

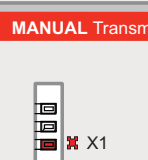

The RED LED will flash once (1x). La DEL ROUGE clignote 1 fois.

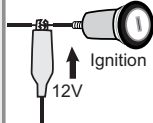

Using a jumper wire, apply power (12v) to the vehicles ignition. À l'aide d'un fil (jumper) appliquez 12v sur l'ignition du véhicule.

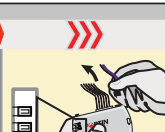

If the LED is solid RED disconnect the 4 Pin connector (Data-Link) and go back to step 1. Si le DEL est Rouge solide débranchez le connecteur 4 pins (Data-Link) et retournez à l'étape 1.

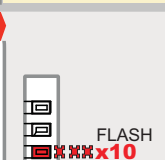

The RED LED will flash rapidly ten (10) times. La DEL ROUGE clignotera dix (10) fois rapidement.

La DEL ROUGE clignotera dix (10) fois rapidement.

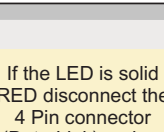

If the LED is solid RED disconnect the 4 Pin connector (Data-Link) and go back to step 1. Si le DEL est Rouge solide débranchez le connecteur 4 pins (Data-Link) et retournez à l'étape 1.

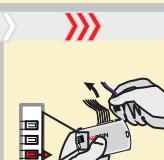

If the LED is solid RED disconnect the 4 Pin connector (Data-Link) and go back to step 1. Si le DEL est Rouge solide débranchez le connecteur 4 pins (Data-Link) et retournez à l'étape 1.



The module is now programmed. Le module est programmé.



Remove the jumper. The module is now programmed. Retirez le fil (jumper). Le module est programmé.



**PROGRAM. 2**

**FORD / MAZDA**

**SCAN TOOL REQUIRED | SCAN TOOL REQUIS**

**1**

Or | Ou



Insert the key in to the ignition barrel.  
**Insérez la clé dans le barillet d'ignition.**



Press the Push to start button to turn ON the ignition.  
**Appuyez sur le bouton démarrage pour mettre l'ignition en position ON.**



Wait 1 minute.  
**Attendez (1) une minute.**

**2**



Press and hold the programming button:

**Appuyez et maintenez enfoncé le bouton de programmation:**



Insert the required remaining connectors: 20 pin (White), 5 pin (White), 6 pin (Red), 2 pin (White).

**Insérez les connecteurs requis restants:** 20 pins (Blanc), 2 pins (Blanc), 5 pins (Blanc), 6 pins (Rouge)

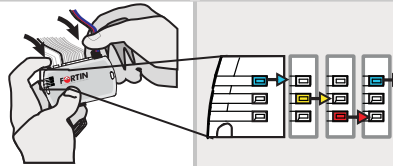

Insert the 4 Pin (Data-Link) connector.

**Insérez le connecteur 4 pins (Data-Link).**

The LED will alternate between BLUE, YELLOW and RED flashes.

Les DELS alternent entre un flash BLEU, JAUNE et ROUGE.

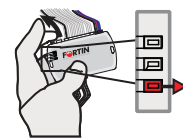

Release the programming button when the LED is **RED.**

**Relâchez le bouton de programmation quand la DEL est ROUGE.**

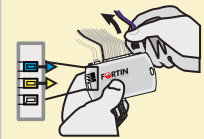

If the LED is not solid RED disconnect the 4 Pin connector (Data-Link) and go back to beginning of step 1. Si le DEL n'est pas ROUGE solide débranchez le connecteur 4 pins (Data-Link) et allez au début de l'étape 1.

**2**

Connect the scan tool. Navigate the SCAN TOOL menu to **program** a new ignition key to the vehicle.  
 **Branchez le SCAN TOOL** Suivre les indications du SCAN TOOL pour **programmer** une nouvelle clé d'ignition.

When the SCAN TOOL is ready to program a new key: Lorsque le SCAN TOOL du concessionnaire est prêt à programmer la nouvelle clé:

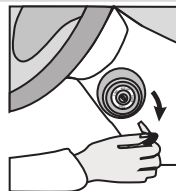

Remove the key from the ignition barrel.  
**Retirez la clé du barillet d'ignition sans éteindre l'ignition.**

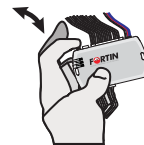

Press and release the programming button on the module.  
**Appuyez et relâchez le bouton de programmation du module.**

Complete the programming on the dealer scan tool.  
**Exécutez la fonction de programmation de la nouvelle clé indiquée sur le Scan Tool.**

Programming was successful if the dealer scan tool indicates that a new ignition key has been programmed to the vehicle  
*La programmation réussie lorsque le scan tool indique qu'une nouvelle clé d'ignition est programmée sur le véhicule.*



FLASH  
**xxx x10**

The RED LED will flash rapidly ten (10) times. Key Bypass programmed.  
**La DEL ROUGE clignotera dix (10) fois rapidement.** Contournement de clé programmé.

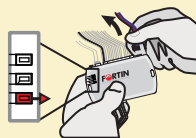

If the LED is solid RED disconnect the 4 Pin connector (Data-Link) and go back to step 1. Si le DEL est ROUGE solide débranchez le connecteur 4 pins (Data-Link) et retournez à l'étape 1.



The module is now programmed.  
**Le module est programmé.**

## PROGRAM. 3

## ACURA / HONDA / CHEVROLET / HYUNDAI / KIA / PONTIAC / SUZUKI / NISSAN / INFINITI / MAZDA

**1**

**Press and hold** the programming button:

**Appuyez et maintenez enfoncé** le bouton de programmation:

**Insert** the required remaining connectors:  
20 pin (White), 5 pin (White), 6 pin (Red), 2 pin (White).

**Insérez** les connecteurs requis restants:  
20 pins (Blanc), 2 pins (Blanc), 5 pins (Blanc), 6 pins (Rouge).

**Insert** the 4 Pin (Data-Link) connector.

**Insérez** le connecteur 4 pins (Data-Link).

The LED will alternate between **BLUE**, **YELLOW** and **RED** flashes.

Les DELS alternent entre un flash **BLEU**, **JAUNE** et **ROUGE**.

**Release** the programming button when the LED is **RED**.

**Relâchez** le bouton de programmation quand la DEL est **ROUGE**.

If the LED is not solid RED disconnect the 4 Pin connector (Data-Link) and go back to beginning of step 1. Si le DEL n'est pas ROUGE solide débranchez le connecteur 4 pins (Data-Link) et allez au début de l'étape 1.

**2**

**Press** the programming button once (1x).

**Appuyez et relâchez** 1 fois le bouton de programmation.

The **RED** LED will turn OFF and turn back ON.

La DEL ROUGE s'éteint et se rallume.

**3**

**Press** the programming button 4 time.

**Appuyez et relâchez** 4 fois le bouton de programmation.

The **RED** LED will flash 4 times every second.

La DEL ROUGE clignote 4 fois chaque seconde.

**4**

**Turn** the Ignition to the ON/RUN position.

**Tournez** la clef en position **ignition (ON)**.

The **RED** LED will flash rapidly ten (10) times. Key Bypass programmed.

La DEL ROUGE clignotera dix (10) fois rapidement.  
Contournement de clé programmé.

The **Blue** LED will flash rapidly. CAN DOOR LOCK programmed.

La DEL BLEU clignotera rapidement: Réseau CAN programmé.

**Turn** the Ignition to the OFF position.

**Tournez** la clef à OFF.







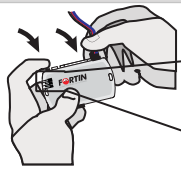
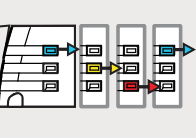
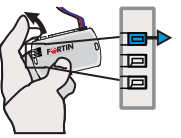

The module is now programmed.

Le module est programmé.

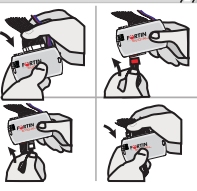
Use the remote of the remote starter or security system to test all of the supported features to ensure proper programming.  
Testez toutes les fonctions supportées sur le véhicule avec la télécommande du démarreur à distance ou du système de sécurité.

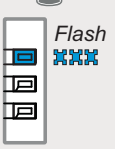
**PROGRAM. 4**

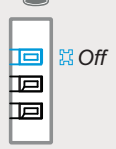
**FORD / LINCOLN**

<p><b>1</b></p>  <p><b>Press and hold</b> the programming button:</p> <p><b>Appuyez et maintenir enfoncé</b> le bouton de programmation:</p>	 <p><b>Insert</b> the 4 Pin (Data-Link) connector.</p> <p><b>Insérez</b> le connecteur 4 pins (Data-Link).</p>	 <p><i>The LED will alternate between BLUE, YELLOW and RED flashes. Les DELS alternent entre un flash BLEU, JAUNE et ROUGE.</i></p>	 <p><b>Release</b> the programming button when the LED is <b>BLUE</b>.</p> <p><b>Relâchez</b> le bouton de programmation quand la DEL est <b>BLEU</b>.</p>	<p><b>▶▶▶</b></p> <p>If the LED is not solid BLUE disconnect the 4 Pin connector (Data-Link) and go back to beginning of step 1.   Si le DEL n'est pas BLEU solide débranchez le connecteur 4 pins (Data-Link) et allez au début de l'étape 1.</p> 	<p><b>2</b></p>  <p><b>Insert</b> the required remaining connectors: 20 pin (White), 5 pin (White), 6 pin (Red), 2 pin (White).</p> <p><b>Insérez</b> les connecteurs requis restants: 20 pins (Blanc), 2 pins (Blanc), 5 pins (Blanc), 6 pins (Rouge)</p>
<p><b>3</b></p>  <p><b>Turn</b> the Ignition to the ON/RUN position.</p> <p><b>Tournez</b> la clef en position <b>ignition (ON)</b>.</p>	 <p><i>The BLUE LED will flash rapidly. La DEL BLEU clignotera rapidement.</i></p>	 <p><b>Turn</b> the Ignition to the OFF position.</p> <p><b>Tournez</b> la clef à OFF.</p>	 <p><i>The BLUE LED will turn off. Le DEL BLEU s'éteint.</i></p>	 <p><i>The module is now programmed. Le module est programmé.</i></p>	

**PROGRAM. 5**

<b>1</b>						<b>2</b>
	<p><b>Press and hold</b> the programming button:</p> <p><b>Appuyez et maintenir enfoncé</b> le bouton de programmation:</p>	<p><b>Insert</b> the 4 Pin (Data-Link) connector.</p> <p><b>Insérez</b> le connecteur 4 pins (Data-Link).</p>	<p><i>The LED will alternate between BLUE, YELLOW and RED flashes. Les DELS alternent entre un flash BLEU, JAUNE et ROUGE.</i></p>	<p><b>Release</b> the programming button when the LED is <b>BLUE</b>.</p> <p><b>Relâchez</b> le bouton de programmation quand la DEL est <b>BLEU</b>.</p>	<p>If the LED is not solid BLUE disconnect the 4 Pin connector (Data-Link) and go back to beginning of step 1.   Si le DEL n'est pas BLEU solide débranchez le connecteur 4 pins (Data-Link) et allez au début de l'étape 1.</p>	<p><b>Insert</b> the required remaining connectors:</p> <p><b>Insérez</b> les connecteurs requis restants:</p> <p>20 pins (Blanc), 5 pins (Blanc), 6 pins (Rouge), 2 pins (Blanc).</p>
<b>3</b>						
	<p><b>Press</b> the Push-to-Start button twice to turn on the ignition. (Do not press the brake pedal)</p> <p><b>Appuyez 2 fois</b> sur le bouton démarrage (Push-to-Start) pour allumer l'ignition. (Ne pas appuyer sur la pédale de frein)</p>	<p><i>Once the Blue LED starts to flash rapidly: Lorsque le DEL Bleu clignote rapidement:</i></p>	<p><b>press</b> the Push-to-Start button once to shut off the ignition.</p> <p><b>appuyez</b> une fois sur le bouton démarrage (Push-to-Start) pour éteindre l'ignition.</p>	<p><i>The LED will turn off. Le DEL s'éteint.</i></p>	<p><i>The module is now programmed. Le module est programmé.</i></p>	

**REMOTE STARTER FUNCTIONALITY | FONCTIONNALITÉS DU DÉMARREUR À DISTANCE**

<p>All doors must be closed.</p> <p>Toutes les portes doivent être fermées</p>	<p><b>Remote start</b> the vehicle.</p> <p><b>Démarrez à distance.</b></p>	<p><b>Press</b> the Unlock button of the remote car starter.</p> <p><b>Appuyez</b> sur le bouton Déverrouillage de la télécommande du démarreur à distance.</p>	<p><b>Enter</b> the vehicle with the Smart-Key.</p> <p><b>Entrez</b> dans le véhicule avec la clé intelligente (Smart-Key) sur vous</p>	<p><i>The vehicle can now be put in to gear and driven.</i></p> <p><i>Vous êtes maintenant prêt à embrayer et prendre la route.</i></p>

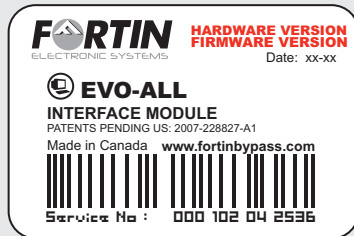
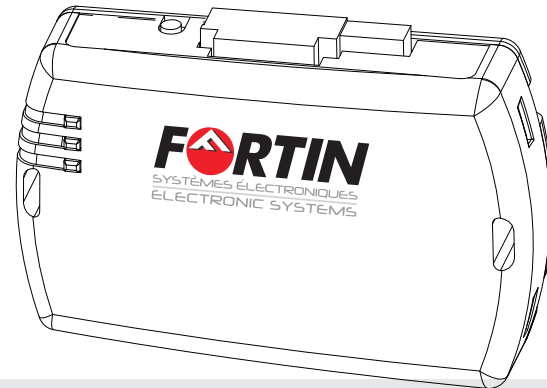

Module label | Étiquette sur le module

## **Notice:** Updated Firmware and Installation Guides

**Updated firmware and installation guides** are posted on our web site on a regular basis. We recommend that you update this module to the latest firmware and download the latest installation guide(s) prior to the installation of this product.

**Des mises à jour du Firmware (microprogramme) et des guides d'installation** sont mises en ligne régulièrement. Vérifiez que vous avez bien la dernière version logiciel et le dernier guide d'installation avant l'installation de ce produit.

## **WARNING / TECH SUPPORT / MISE EN GARDE / SUPPORT TECHNIQUE**

The information on this sheet is provided on an (as is) basis with no representation or warranty of accuracy whatsoever. It is the sole responsibility of the installer to check and verify any circuit before connecting to it. Only a computer safe logic probe or digital multimeter should be used. FORTIN ELECTRONIC SYSTEMS assumes absolutely no liability or responsibility whatsoever pertaining to the accuracy or currency of the information supplied. The installation in every case is the sole responsibility of the installer performing the work and FORTIN ELECTRONIC SYSTEMS assumes no liability or responsibility whatsoever resulting from any type of installation, whether performed properly, improperly or any other way. Neither the manufacturer or distributor of this module is responsible of damages of any kind indirectly or directly caused by this module, except for the replacement of this module in case of manufacturing defects. This module must be installed by qualified technician. The information supplied is a guide only. This instruction guide may change without notice. **Visit [www.fortinbypass.com](http://www.fortinbypass.com) to get the latest version.**

L'information de ce guide est fournie sur la base de représentation (telle quelle) sans aucune garantie de précision et d'exactitude. Il est de la seule responsabilité de l'installateur de vérifier tous les fils et circuit avant défectuer les connections. Seule une sonde logique ou un multimètre digital doivent être utilisés. FORTIN SYSTÈMES ÉLECTRONIQUES n'assume aucune responsabilité de l'exactitude de l'information fournie. L'installation (dans chaque cas) est la responsabilité de l'installateur effectuant le travail. FORTIN SYSTÈMES ÉLECTRONIQUES n'assume aucune responsabilité suite à l'installation, que celle-ci soit bonne ou mauvaise ou de n'importe autre type. Ni le fabricant, ni le distributeur ne se considèrent responsables des dommages causés ou ayant pu être causés, indirectement ou directement, par ce module, excepté le remplacement de ce module en cas de défectuosité de fabrication. Ce module doit être installé par un technicien qualifié. L'information fournie dans ce guide est une suggestion. Ce guide d'instruction peut faire l'objet de changement sans préavis. **Consultez le [www.fortinbypass.com](http://www.fortinbypass.com) pour voir la plus récente version.**

Copyright © 2006-2011, FORTIN AUTO RADIO INC ALL RIGHTS RESERVED **PATENT PENDING**



**TECH SUPPORT**  
Tél: 514-255-HELP (4357)  
1-877-336-7797



**ADDENDUM GUIDE**

**[www.fortinbypass.com](http://www.fortinbypass.com)**  
WEB UPDATE | MISE À JOUR INTERNET

