

SELF LEARNING ENCRYPTED TRANSPONDER BYPASS MODULE MODULE DE CONTOURNEMENT DE TRANSPONDEUR ENCRYPTÉ

THIS MANUAL IS SUBJECT TO CHANGE WITHOUT NOTICE
CE MANUEL PEUT FAIRE L'OBJET DE CHANGEMENTS SANS PRÉAVIS

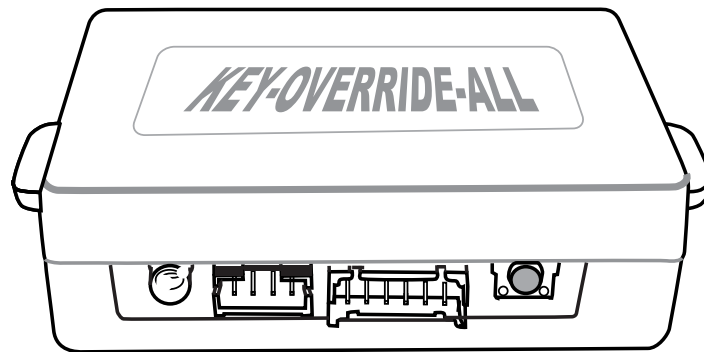

Module label | Étiquette sur le module

Notice: Updated Firmware and Installation Guides

Updated firmware and installation guides are posted on our web site on a regular basis. We recommend that you update this module to the latest firmware and download the latest installation guide(s) prior to the installation of this product.

Des mises à jour du Firmware (microprogramme) et des guides d'installation sont mis en ligne régulièrement. Vérifiez que vous avez bien la dernière version logiciel et le dernier guide d'installation avant l'installation de ce produit.



TECHNICAL SUPPORT

Tél: 514-255-HELP (4357)
1-877-336-7797



INSTALLATION GUIDE
Rev.20130219





www.fortinbypass.com

WEB UPDATE | MISE À JOUR INTERNET



Copyright © 2009-2011
FORTIN AUTO RADIO INC
ALL RIGHTS RESERVED

WIRE LEGEND | LEGENDE

	Input <i>Entrée</i>		Connect to vehicle <i>Branchement au véhicule</i>		Connect to Remote-Starter/Alarm <i>Branchement au démarreur à distance/Alarme</i>
	Output <i>Sortie</i>				

DESCRIPTION See connection | Voir connexions

Make the connections and programming associated with the vehicle in the VEHICLE FITGUIDE (Page 4-6).
Déterminez le type de branchement et de programmation selon le GUIDE DES VÉHICULES (Page 4-6).

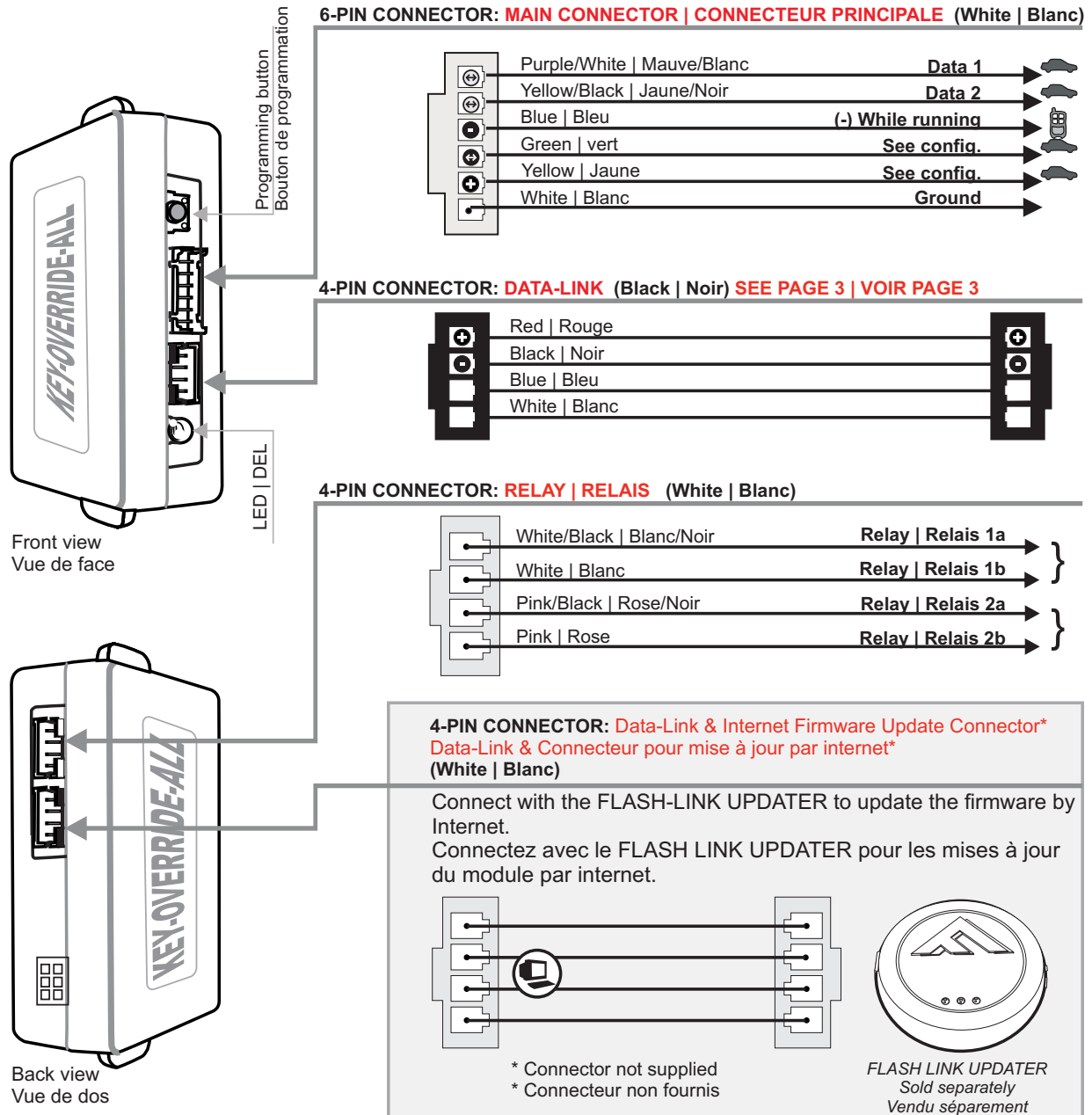

LED DIAGNOSTIC | DIAGNOSTIQUES DES DELs

LED OFF: Not activated
DEL Éteint: Le module n'est pas activé

LED ON: Activated
DEL Allumé: Le module est activé

LED Flash: Not programmed.
DEL Flash: Le module n'est pas programmé.

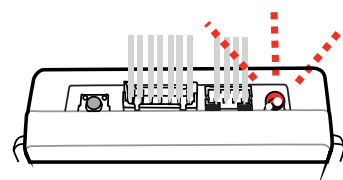
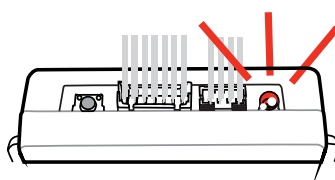
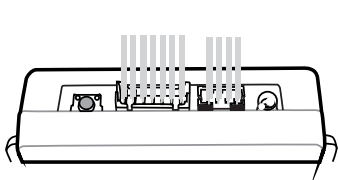

INSTALLATION PROCEDURE

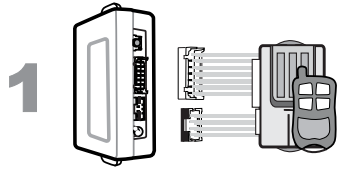

Determine if the remote-starter or alarm system supports 2-way Data-Link.

Déterminez si le démarreur à distance ou système d'alarme est compatible en Data-Link 2-voies.

WITH DATA-LINK AVEC DATA-LINK

WITH OUT DATA-LINK SANS DATA-LINK

In order to utilize this type of connection the remote-starter or alarm-system must be compatible with the **Fortin Data-link protocol**. Consult the installation guide or visit www.fortinbypass.com/datalink/ for more information.

For all other remote-starters or alarm-systems perform the following connections.

Pour tout autres types de démarreurs à distance ou d'alarme, effectuez les branchements suivants.

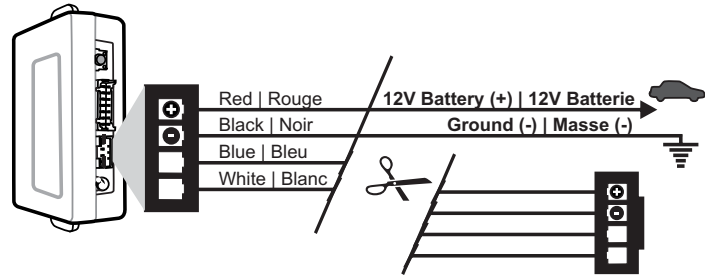
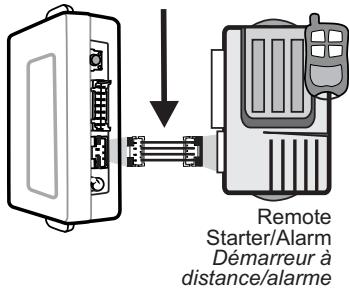

Le démarreur à distance ou le système d'alarme doit être compatible avec le **protocole Data-link Fortin** pour ces branchements. Consultez le guide d'installation du démarreur à distance ou du système d'alarme ou visitez le www.fortinbypass.com/datalink/ pour plus d'informations.

- Cut** off one plug of the 4 Pin Data-Link connector
- Connect** the Red wire to +12V
- Connect** the Black wire to Ground

- Coupez** l'extrémité du connecteur 4 pins Data-Link
- Connectez** le fil rouge au 12V
- Connectez** le fil noir à la masse du véhicule.



Make the connections:

Faire les branchements:

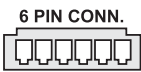

6-pin Connector (White):
Make the connections associated with the vehicle from the VEHICLE FIT GUIDE.

6-pins Connecteur (Blanc):
Effectuez les branchements associés au véhicule dans le GUIDE DES VÉHICULES.

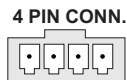

4-pin Connector RELAY (White):
Make the connections (if required)

5-pins Connecteur RELAIS (Blanc):
Effectuez les branchements.(Si nécessaire)



PROGRAMMING PROCEDURE

PROCÉDURE DE PROGRAMMATION

Determine the programming procedure required for the vehicle in the VEHICLE FIT GUIDE.

Déterminez le type de programmation selon votre véhicule dans le GUIDE DES VÉHICULES.

Connection number Numéro de connexion	Vehicle(s) associated with the procedure Véhicule(s) associé(s) à la configuration	Programming number Numéro de programmation
CONNECTION #	VEHICLE MAKE MODEL YEAR	PROGRAM: #

VEHICLE FIT GUIDE | GUIDE DES VÉHICULES

VEHICLE VEHICULES	YEARS ANNÉES	Connection # (Page X)	Programming # (Page X)
ACURA			
CL	1998-2003	7 (P.10)	5A (P.18)
CSX	2006-2011	8 (P.10)	5A (P.18)
EL	1998-2000	7 (P.10)	5A (P.18)
	2001-2005	6 (P.10)	5A (P.18)
Integra	2000-2001	7 (P.10)	5A (P.18)
MDX	2001-2002	7 (P.10)	5A (P.18)
	2003-2006	6 (P.10)	5A (P.18)
	2007-2013	8 (P.10)	5A (P.18)
RDX	2007-2012	8 (P.10)	5A (P.18)
RL	1998-2004	17 (P.13)	5D (P.18)
	2005-2012	18 (P.13)	5A (P.18)
RSX	2002-2006	6 (P.10)	5A (P.18)
TL	1998-2003	7 (P.10)	5A (P.18)
	2004-2012	6 (P.10)	5A (P.18)
TSX	2004-2008	6 (P.10)	5A (P.18)
	2009-2013	9 (P.11)	5A (P.18)
CHEVROLET			
Aveo	2004-2006 2008	10 (P.11)	5B (P.18)
Epica	2004-2007	11 (P.11)	5B (P.18)
Venture	1998-1999	2 (P.7)	5E (P.18)
FORD			
Contour	1998-2000	1C (P.7)	1 (P.15)
Crown Victoria	1997-2002	1H (P.7)	1 (P.15)
	2003-2004	1B (P.7)	2 (P.16)
	2005-2011	1A (P.7)	2 (P.16)
Econoline - E Series	2008-2012	1B (P.7)	2 (P.16)
Edge	2007-2010	1A (P.7)	2 (P.16)
Escape	2001-2007	1C (P.7)	2 (P.16)
	2008-2011	1A (P.7)	2 (P.16)
Escape Hybrid	2005-2007	1C (P.7)	2 (P.16)
	2008-2011	1A (P.7)	2 (P.16)
Excursion	2000-2002	1H (P.7)	1 (P.15)
	2003	1A (P.7)	2 (P.16)
	2004-2005	1A (P.7)	2 (P.16)
Expedition	1997-2001	1H (P.7)	1 (P.15)
	2002	1A (P.7)	2 (P.16)
	2003-2006	1C (P.7)	2 (P.16)
	2007-2012	1A (P.7)	2 (P.16)
Explorer	1998-2000	1H (P.7)	1 (P.15)
	2001	1C (P.7)	2 (P.16)
	2002-2005	1C (P.7)	2 (P.16)
	2006-2010	1A (P.7)	2 (P.16)
Explorer Sport Trac	2001	1B (P.7)	2 (P.16)
	2002-2005	1A (P.7)	2 (P.16)
	2006-2010	1A (P.7)	2 (P.16)
Fiesta	2011-2013	1A (P.7)	2 (P.16)
F150	1999-2002	1H (P.7)	1 (P.15)
	2003	1B (P.7)	1 (P.15)
	2004-2008	1C (P.7)	2 (P.16)
	2009-2010	1A (P.7)	2 (P.16)
F250 / F350 / F450	2007-2010	1A (P.7)	2 (P.16)
Five Hundred	2005-2007	1A (P.7)	2 (P.16)
Flex	2009-2012	1A (P.7)	2 (P.16)
Focus	2000-2007	1C (P.7)	2 (P.16)
	2008-2011	1A (P.7)	2 (P.16)
Freestar	2004-2007	1B (P.7)	2 (P.16)
Freestyle	2005-2007	1A (P.7)	2 (P.16)

VEHICLE VEHICULES	YEARS ANNÉES	Connection # (Page X)	Programming # (Page X)
Fusion	2006-2012	1A (P.7)	2 (P.16)
GT	2005-2006	1A (P.7)	2 (P.16)
Mustang	1999-2002	1A (P.7)	1 (P.15)
	2003-2004	1A (P.7)	1 (P.15)
	2005-2013	1A (P.7)	2 (P.16)
Ranger	1999-2000	1B (P.7)	1 (P.15)
	2001-2006	1D (P.7)	2 (P.16)
	2007-2012	1B (P.7)	2 (P.16)
Taurus	1996-1999	1D (P.7)	1 (P.15)
	2000-2007	1B (P.7)	2 (P.16)
	2008-2010	1A (P.7)	2 (P.16)
Taurus X	2008-2009	1A (P.7)	2 (P.16)
Thunderbird	2002-2005	1C (P.7)	2 (P.16)
Transit Connect	2010-2012	1i (P.7)	2 (P.16)
Windstar	1999-2000	1B (P.7)	1 (P.15)
	2001-2003	1B (P.7)	2 (P.16)
HONDA			
Accord	1998-2002	7 (P.10)	5A (P.18)
	2003-2007	6 (P.10)	5A (P.18)
	2008-2012	9 (P.11)	5A (P.18)
Civic	2001-2005	6 (P.10)	5A (P.18)
	2006-2011	8 (P.10)	5A (P.18)
	2012-2013	9 (P.11)	5A (P.18)
CR-V	1998-2001	7 (P.10)	5A (P.18)
	2002-2006	6 (P.10)	5A (P.18)
	2007-2011	8 (P.10)	5A (P.18)
	2012-2013	9 (P.11)	5A (P.18)
CR-Z Hybrid	2011-2013	8 (P.10)	5A (P.18)
Element	2003-2011	6 (P.10)	5A (P.18)
Fit	2006-2008	6 (P.10)	5A (P.18)
	2009-2013	8 (P.10)	5A (P.18)
Insight	2010-2013	8 (P.10)	5A (P.18)
Odyssey	1998-2004	7 (P.10)	5A (P.18)
	2005-2010	6 (P.10)	5A (P.18)
	2011-2013	9 (P.11)	5A (P.18)
Pilot	2003-2004	7 (P.10)	5A (P.18)
	2005-2008	6 (P.10)	5A (P.18)
	2009-2013	9 (P.11)	5A (P.18)
Prelude	1997-2001	17 (P.13)	5A (P.18)
Ridgeline	2006-2013	6 (P.10)	5A (P.18)
S2000	2000-2003	7 (P.10)	5A (P.18)
	2004-2009	6 (P.10)	5A (P.18)
HYUNDAI			
Tiburon 6 cyl.	2002-2008	13 (P.12)	5B (P.18)
Tucson	2004-2007	14 (P.12)	5B (P.18)
XG300	2001	12 (P.11)	5B (P.18)
XG350	2002-2005	12 (P.11)	5B (P.18)
INFINITI			
G20	2001-2002	15 (P.12)	5C (P.18)
I30	2001	15 (P.12)	5C (P.18)
I35	2002-2004	15 (P.12)	5C (P.18)
QX4	2001-2003	15 (P.12)	5C (P.18)
JAGUAR			
S-Type	2000-2007	1C (P.7)	2 (P.16)
X-Type	2002-2009	1C (P.7)	2 (P.16)
XJ8 / XJR	2004	1C (P.7)	2 (P.16)
KIA			
Sedona / Carnival	2004-2005	14 (P.12)	5B (P.18)

VEHICLE FIT GUIDE | GUIDE DES VÉHICULES

VEHICLE VEHICULES	YEARS ANNÉES	Connection # (Page X)	Programming # (Page X)
Sorento	2004-2006	14 (P.12)	5B (P.18)
Sportage	2005-2007	14 (P.12)	5B (P.18)
LEXUS			
ES 300	1998-2003	5 (P.9)	3 (P.17)
ES 330	2004-2006	4 (P.9)	3 (P.17)
	<i>Push-to-Start</i> 2004-2006	3 (P.8)	4 (P.17)
ES 350	2007-2008	4 (P.9)	3 (P.17)
	<i>Push-to-Start</i> 2007-2009	3 (P.8)	4 (P.17)
	<i>Push-to-Start</i> 2009-2012	www : 1905	
GS 300	1998-2005	5 (P.9)	3 (P.17)
	<i>Push-to-Start</i> 2006	3 (P.8)	4 (P.17)
GS 350	2007-2008	4 (P.9)	3 (P.17)
	<i>Push-to-Start</i> 2007-2008	3 (P.8)	4 (P.17)
	<i>Push-to-Start</i> 2009-2011	www : 3293	
GS 400	1997-2000	5 (P.9)	3 (P.17)
GS 430	2001-2005	5 (P.9)	3 (P.17)
	2006-2007	4 (P.9)	3 (P.17)
	<i>Push-to-Start</i> 2006-2007	3 (P.8)	4 (P.17)
GS 450H	2007-2008	4 (P.9)	3 (P.17)
	<i>Push-to-Start</i> 2007-2011	3 (P.8)	4 (P.17)
GS 460	2008	4 (P.9)	3 (P.17)
	<i>Push-to-Start</i> 2009-2011	www : 3293	
GX460	<i>Push-to-Start</i> 2010-2013	3 (P.8)	4 (P.17)
GX470	2003-2009	4 (P.9)	3 (P.17)
	<i>Push-to-Start</i> 2007-2009	3 (P.8)	4 (P.17)
IS 250	2006-2008	4 (P.9)	3 (P.17)
	<i>Push-to-Start</i> 2007-2008	3 (P.8)	4 (P.17)
	<i>Push-to-Start</i> 2008-2011	www : 1806	
IS 300	2001-2005	5 (P.9)	3 (P.17)
IS 350	<i>Push-to-Start</i> 2006-2008	3 (P.8)	4 (P.17)
	<i>Push-to-Start</i> 2009-2011	www : 1806	
LS 400	1997-2000	5 (P.9)	3 (P.17)
LS 430	2003-2006	4 (P.9)	3 (P.17)
	<i>Push-to-Start</i> 2004-2006	3 (P.8)	4 (P.17)
LS 460	<i>Push-to-Start</i> 2007-2008	3 (P.8)	4 (P.17)
LS 600H	<i>Push-to-Start</i> 2008-2009	3 (P.8)	4 (P.17)
LX 470	1998-2002	5 (P.9)	3 (P.17)
	2003-2007	4 (P.9)	3 (P.17)
	<i>Push-to-Start</i> 2007	3 (P.8)	4 (P.17)
LX 570	<i>Push-to-Start</i> 2008	3 (P.8)	4 (P.17)
RX 300	1999-2003	5 (P.9)	3 (P.17)
RX 330	2004-2006	4 (P.9)	3 (P.17)
RX 350	2007-2008	4 (P.9)	3 (P.17)
	<i>Push-to-Start</i> 2007-2008	3 (P.8)	4 (P.17)
	<i>Push-to-Start</i> 2009-2013	www : 2006	
RX 400H	2006-2008	4 (P.9)	3 (P.17)
<i>Push-to-Start</i>	2006-2008	3 (P.8)	4 (P.17)
SC 300	1998-2000	5 (P.9)	3 (P.17)
SC 400	1998-2000	5 (P.9)	3 (P.17)
LINCOLN			
Aviator	2003-2005	1C (P.7)	2 (P.16)
Blackwood	2002-2003	1B (P.7)	1 (P.15)
Continental	1997-2002	1H (P.7)	1 (P.15)
LS	2000-2006	1C (P.7)	2 (P.16)
Mark LT	2006-2008	1C (P.7)	2 (P.16)
MKX	2007-2012	1A (P.7)	2 (P.16)
MKZ	2007-2012	1A (P.7)	2 (P.16)

VEHICLE VEHICULES	YEARS ANNÉES	Connection # (Page X)	Programming # (Page X)
Navigator	1998-2001	1H (P.7)	1 (P.15)
	2002	1B (P.7)	2 (P.16)
	2003-2006	1C (P.7)	2 (P.16)
	2007-2012	1A (P.7)	2 (P.16)
Town Car	1997-2002	1H (P.7)	1 (P.15)
	2003-2004	1A (P.7)	2 (P.16)
	2005-2011	1A (P.7)	2 (P.16)
Zephyr	2006	1A (P.7)	2 (P.16)
MAZDA			
2	2011-2012	1G (P.7)	2 (P.16)
3 / Axela	2004-2012	1F (P.7)	2 (P.16)
	<i>Smart Keyless</i> 2010-2012	1F (P.7)	6 (P.19)
5	2006-2012	1F (P.7)	2 (P.16)
6 / Atenza	2003-2008	1F (P.7)	2 (P.16)
	2009-2012	1A (P.7)	2 (P.16)
	<i>Smart Keyless</i> 2009-2012	1E (P.7)	6 (P.19)
B-Series	1999-2001	1i (P.7)	1 (P.15)
	2002-2009	1B (P.7)	2 (P.16)
CX-7	2007-2012	1F (P.7)	2 (P.16)
CX-9	2007-2012	1F (P.7)	2 (P.16)
MPV	2000-2006	16 (P.13)	5D (P.18)
Miata	2002-2005	16 (P.13)	5D (P.18)
MX-5	2006-2012	1F (P.7)	2 (P.16)
RX-8	2003-2011	1F (P.7)	2 (P.16)
Tribute	2001-2012	1C (P.7)	2 (P.16)
MERCURY			
Cougar	1999-2002	1C (P.7)	1 (P.15)
Grand Marquis	1998-2002	1H (P.7)	1 (P.15)
	2003-2004	1B (P.7)	2 (P.16)
	2005-2010	1A (P.7)	2 (P.16)
Marauder	2003-2004	1B (P.7)	2 (P.16)
Mariner	2005-2007	1C (P.7)	2 (P.16)
	2008-2010	1A (P.7)	2 (P.16)
Mariner Hybrid	2005-2007	1C (P.7)	2 (P.16)
	2008-2010	1A (P.7)	2 (P.16)
Milan	2006	1B (P.7)	2 (P.16)
	2007-2010	1A (P.7)	2 (P.16)
Montego	2005-2007	1B (P.7)	2 (P.16)
Monterey	2004-2007	1A (P.7)	2 (P.16)
Mountaineer	1998-2000	1H (P.7)	1 (P.15)
	2001	1B (P.7)	2 (P.16)
	2002-2005	1C (P.7)	2 (P.16)
	2006-2010	1A (P.7)	2 (P.16)
Mystique	1998-2000	1C (P.7)	1 (P.15)
Sable	1996-1999	1D (P.7)	1 (P.15)
	2000-2009	1A (P.7)	2 (P.16)
NISSAN			
Altima	2001-2004	15 (P.12)	5C (P.18)
Maxima	2001-2003	15 (P.12)	5C (P.18)
Pathfinder	2001-2004	15 (P.12)	5C (P.18)
Sentra	2001-2006	15 (P.12)	5C (P.18)
XTrail	2005-2007	15 (P.12)	5C (P.18)
OLDSMOBILE			
Silhouette	1998-1999	2 (P.7)	5E (P.18)
PONTIAC			
Grand Prix	2000-2001	2 (P.7)	5E (P.18)
Montana	2000-2001	2 (P.7)	5E (P.18)
Vibe	2008-2010	4 (P.9)	3 (P.17)

VEHICLE FIT GUIDE | GUIDE DES VÉHICULES

VEHICLE VEHICULES	YEARS ANNÉES	Connection # (Page X)	Programming # (Page X)
Wave	2004-2006	10 (P.11)	5B (P.18)
	2008	10 (P.11)	5B (P.18)
SCION			
iQ	2012	20 (P.14)	3 (P.17)
tC	2005-2010	4 (P.9)	3 (P.17)
	80-bit G-key 2010-2012	19 (P.14)	3 (P.17)
xB	2008-2010	4 (P.9)	3 (P.17)
	80-bit G-key 2010-2012	19 (P.14)	3 (P.17)
xD	2008-2010	4 (P.9)	3 (P.17)
	80-bit G-key 2010-2011	19 (P.14)	3 (P.17)
SUZUKI			
Swift	2005-2006	10 (P.11)	5B (P.18)
	2008		
Verona	2004-2006	11 (P.11)	5B (P.18)
TOYOTA			
4 Runner	1999-2002	5 (P.9)	3 (P.17)
	2003-2009	4 (P.9)	3 (P.17)
	80-bit G-key 2010-2013	19 (P.14)	3 (P.17)
	Push-to-Start 2010-2013	www : 2048	
Avalon	1998-2004	5 (P.9)	3 (P.17)
	2005-2012	4 (P.9)	3 (P.17)
	80-bit G-key 2010-2012	19 (P.14)	3 (P.17)
	Push-to-Start 2005-2012	3 (P.8)	4 (P.17)
Camry	1998-2004	5 (P.9)	3 (P.17)
	2003-2010	4 (P.9)	3 (P.17)
	Push-to-Start 2006-2008	3 (P.8)	4 (P.17)
	Push-to-Start 2009-2011	www : 1904	
	80-bit G-key 2009-2011	20 (P.14)	3 (P.17)
Hybrid Push-to-Start	2007-2011	3 (P.8)	4 (P.17)
Corolla	2005-2010	4 (P.9)	3 (P.17)
	Push-to-Start 2009-2010	3 (P.8)	4 (P.17)
	80-bit G-key 2010-2012	19 (P.14)	3 (P.17)
	80-bit Push-to-Start 2011-2013	www : 3166	
FJ Cruiser	2007-2009	4 (P.9)	3 (P.17)
	80-bit G-key 2010-2013	20 (P.14)	3 (P.17)
Highlander - Kluger	2001-2003	5 (P.9)	3 (P.17)
	2004-2010	4 (P.9)	3 (P.17)
	80-bit G-key 2010-2012	19 (P.14)	3 (P.17)
	Push-to-Start 2008-2010	3 (P.8)	4 (P.17)
	Push-to-Start 2011-2012	www : 3600	
Hybrid	2006-2012	4 (P.9)	3 (P.17)
Land Cruiser	1998-2002	5 (P.9)	3 (P.17)
	2003-2009	4 (P.9)	3 (P.17)
Matrix	2005-2010	4 (P.9)	3 (P.17)
	80-bit G-key 2010-2012	20 (P.14)	3 (P.17)
MR2 - Spyder	2003-2005	5 (P.9)	3 (P.17)
Prius	Push-to-Start 2004-2011	www : 1503	
Rav4	2001-2003	5 (P.9)	3 (P.17)
	2004-2010	4 (P.9)	3 (P.17)
	80-bit G-key 2010-2012	19 (P.14)	3 (P.17)
	Push-to-Start after 09/2009 2010-2012	www : 2316	
Sequoia	2005-2007	www : 3616	
	2008-2009	4 (P.9)	3 (P.17)
	80-bit G-key 2010-2012	www : 2487	
Sienna	1998-2003	5 (P.9)	3 (P.17)
	2004-2010	4 (P.9)	3 (P.17)
	80-bit G-key 2011-2013	20 (P.14)	3 (P.17)
	Push-to-Start 2011-2013	www : 2116	

VEHICLE VEHICULES	YEARS ANNÉES	Connection # (Page X)	Programming # (Page X)
Solara	1999-2003	5 (P.9)	3 (P.17)
	2004-2008	4 (P.9)	3 (P.17)
	Push-to-Start 2007-2009	3 (P.8)	4 (P.17)
Tacoma	2005-2010	4 (P.9)	3 (P.17)
	80-bit G-key 2010-2012	19 (P.14)	3 (P.17)
Tundra	2007-2010	4 (P.9)	3 (P.17)
	80-bit G-key 2010-2012	20 (P.14)	3 (P.17)
Venza	2009-2010	4 (P.9)	3 (P.17)
	80-bit G-key 2009-2013	19 (P.14)	3 (P.17)
	Push-to-Start 2009-2013	www : 3311	
Yaris	2006-2010	4 (P.9)	3 (P.17)
	80-bit G-key 2010-2011	19 (P.14)	3 (P.17)
	Sedan 2012	4 (P.9)	3 (P.17)

LEGEND | LÉGENDE

www - Visit www.fortinbypass.com to download an installation guide for this specific vehicle. | Visitez le www.fortinbypass.com pour télécharger un guide d'installation spécifique à ce véhicule.

CONNECTION

CONNECTION 1

FORD / MAZDA / JAGUAR / LINCOLN / MERCURY

GO PROGRAM: 1

or GO PROGRAM: 2

Push to Start GO PROGRAM: 6

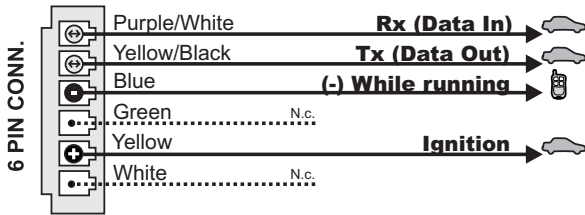

Ignition barrel
Barillet de l'ignition

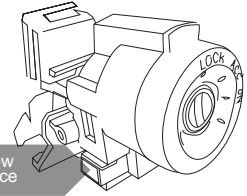

IGNITION BARREL CONNECTOR | CONNECTEURS AU BARILLET D'IGNITION

Back view
Back Face

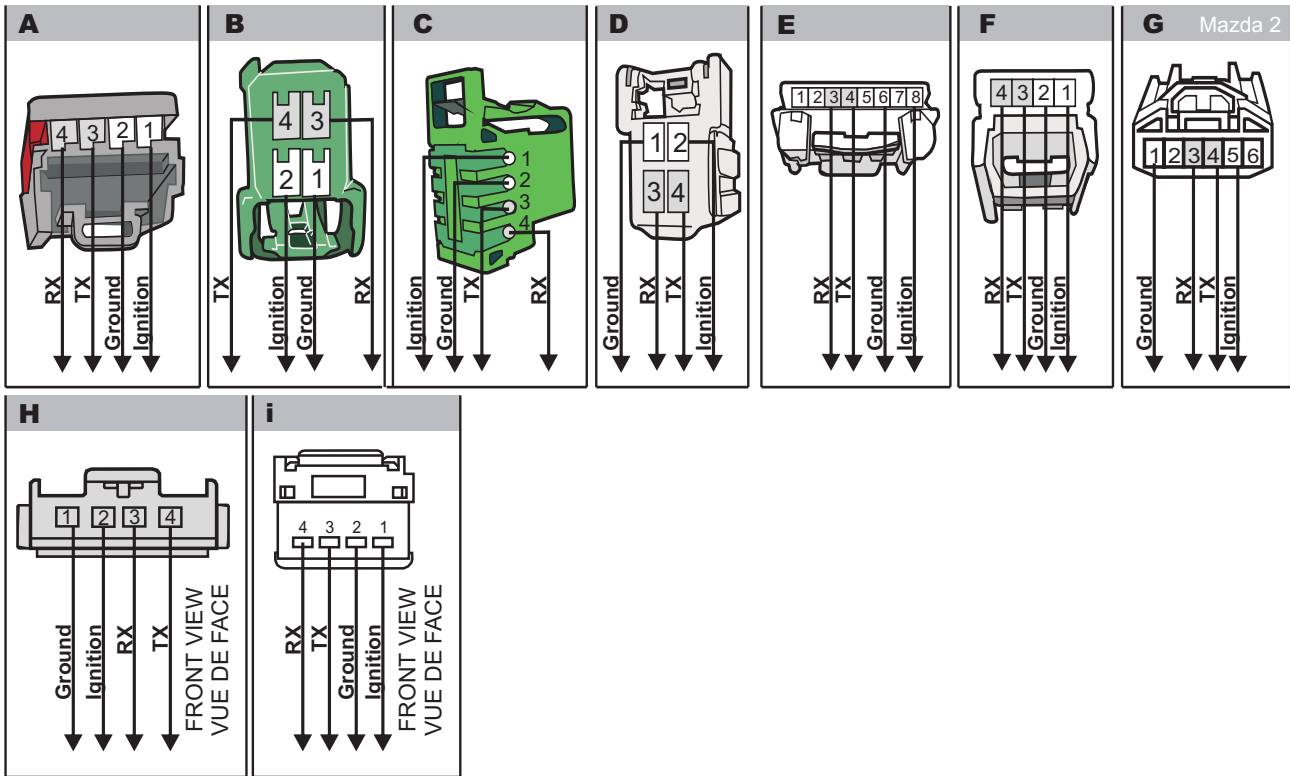

CONNECTION 2

CHEVROLET / OLDSMOBILE / PONTIAC

GO PROGRAM: 5E

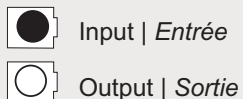
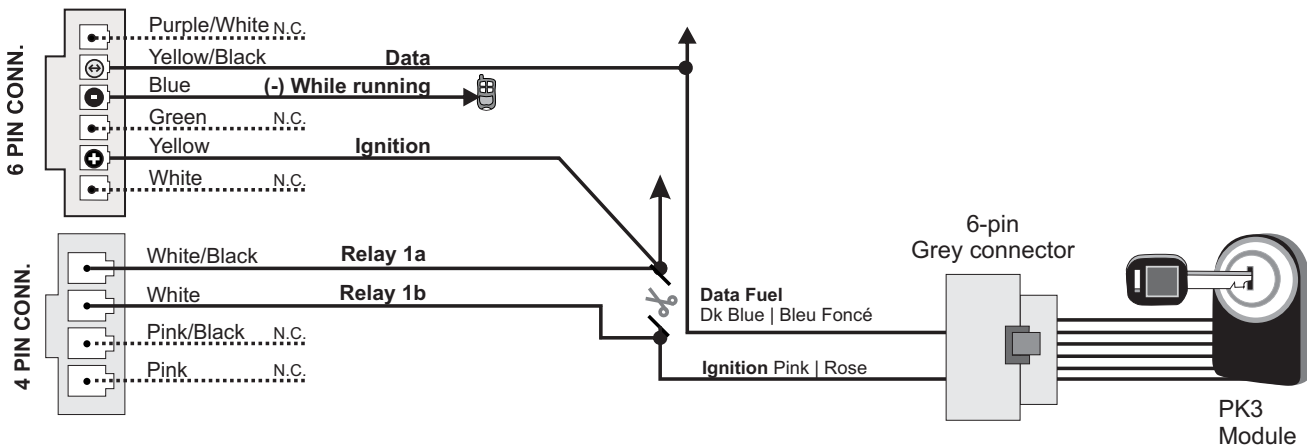

Connect to vehicle
Branchement au véhicule

Connect to Remote-Starter/Alarm
Branchement au démarreur
à distance/Alarme

CONNECTION 3 SUGGESTED INSTALLATION : TOYOTA / LEXUS SMART KEY **GO PROGRAM: 4**

Firmware version 2.01+ required | Version logicielle 2.01+ requise

Components required | Composantes requises:

- 2x Diodes 1 Amp | Diodes 1Amp
- 2x 5 Amp fuse | Fusibles 5 Amp
- 1x Relay | Relais
- 1x 1Kohms Resistor | Résistance 1Kohms

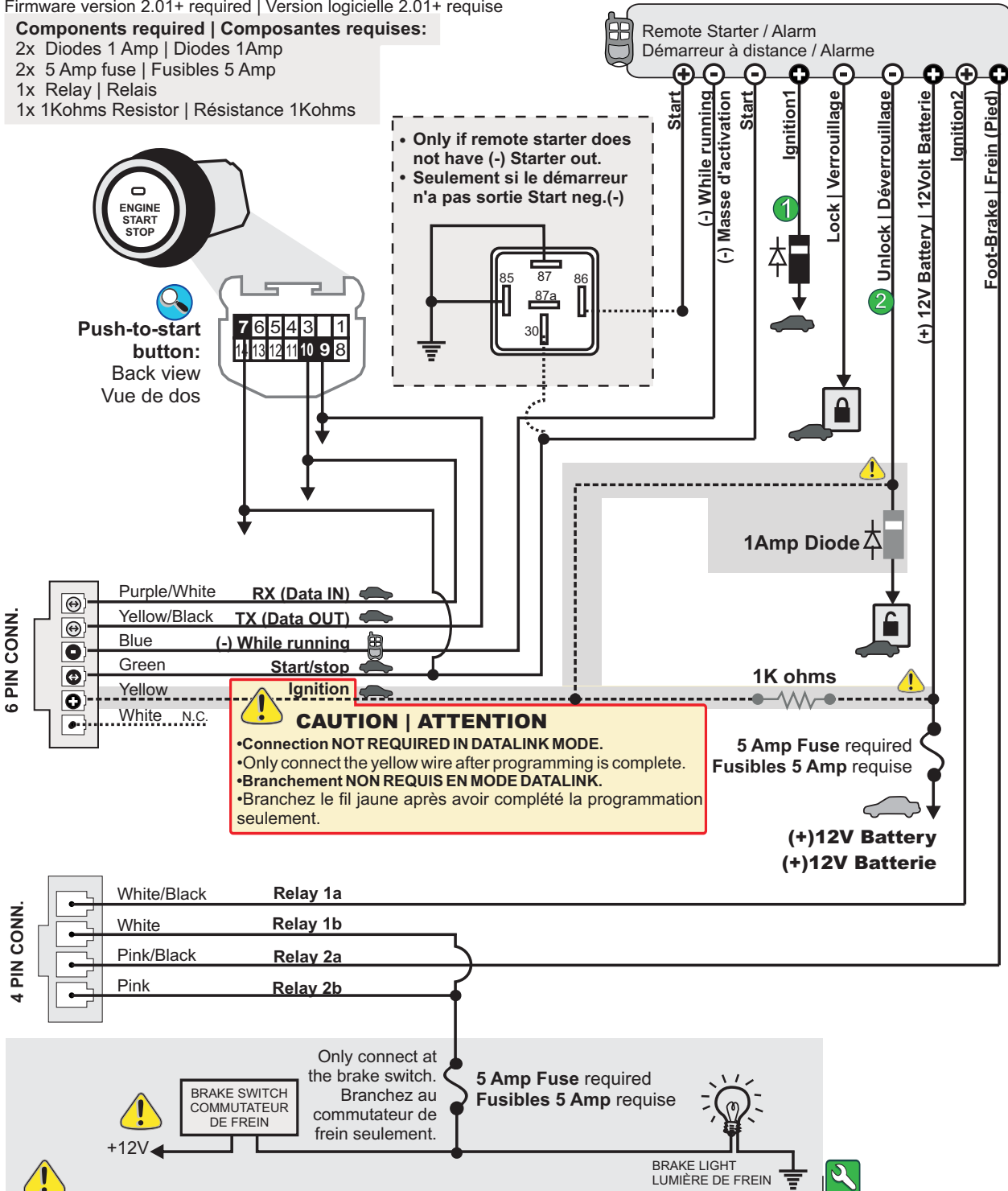

CAUTION | ATTENTION

- Connection NOT REQUIRED IN DATALINK MODE.
- Only connect the yellow wire after programming is complete.
- Branchement NON REQUIS EN MODE DATALINK.
- Branchez le fil jaune après avoir complété la programmation seulement.

The remote starter must be programmed in DIESEL mode (Wait to Start) in order to activate the foot-brake at least 5 seconds before remote-start. Le démarreur doit être programmé en mode DIESEL (attendre avant démarrage) de façon à ce que la pédale de frein soit activée 5 secondes avant le démarrage à distance.

Once remote-started, the module will shut-down the engine when the GWR is removed. The module will delay the shut-down for 45 seconds if the doors are unlocked first. This allows the customer enough time to get in and shut down the remote-starter with the foot-brake normally.

If the SMART-KEY is in proximity when the vehicle is remote-started, the module will not shut down the engine when the GWR is removed.

Il est normal que les lumières de freins sont allumées avant le démarrage. Une fois le véhicule démarré à distance, le module commande l'arrêt du moteur lorsque la masse d'activation est retirée. Cette fonction peut être contournée en appuyant sur le bouton Déverrouillage de la télécommande du démarreur, le conducteur a alors 45 secondes pour entrer dans la voiture et peser sur la pédale de frein avant que le moteur ne s'arrête. Si le véhicule est démarré par démarrage à distance avec le SMARTKEY à l'intérieur du véhicule, le module ne commandera pas l'arrêt du moteur lorsque la masse d'activation est retirée.



- 1 Connect to ignition(+) at the fuse box. | Connectez à Ignition(+) de la boîte à fusible.
- 2 Unlock must be **connected** because the doors can not be unlocked using the OEM remote once the vehicle is remote-started. Déverrouillage doit être **branché** car l'option car les portes ne peuvent pas se déverrouiller avec les télécommandes d'origine lorsque le moteur est en fonction.

CONNECTION 4

TOYOTA / LEXUS

GO PROGRAM: 3

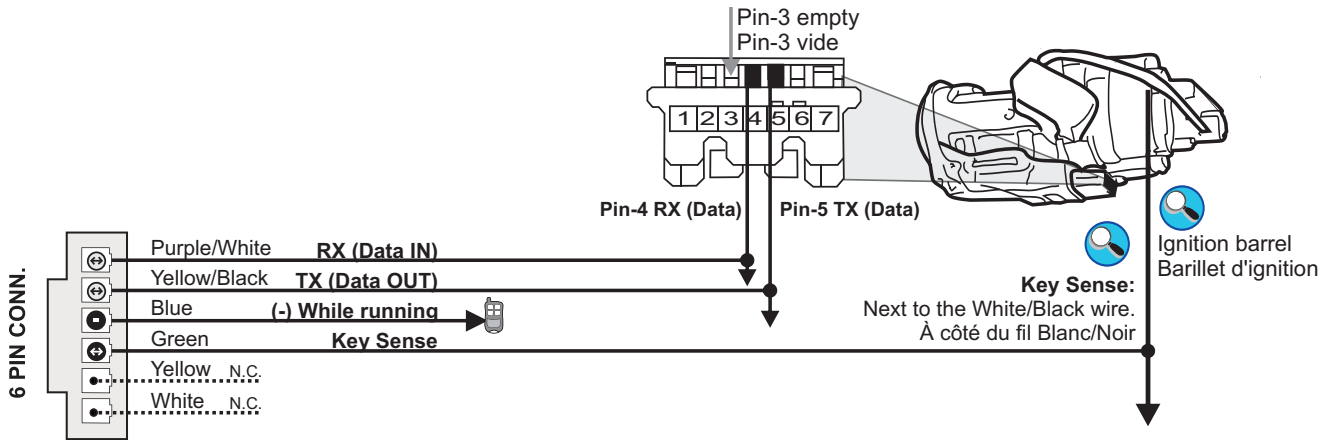

CONNECTION 5

TOYOTA / LEXUS

GO PROGRAM: 3

LEXUS	YEARS	CLK	DATA	Synchro	Key Sense	TOYOTA	YEARS	CLK	DATA	Synchro	Key Sense
ES 300	98-01	Red/Blue	Green/White	Blue/Yellow	Blue/Black	4Runner	99-02	Red/Black	Gray/Red	Pink/Black	Yellow/Red
	02-03	Red/Blue	Green/White	Blue/Yellow	Blue	Avalon	98-99	Yellow	Black/Red	Green	Red/Yellow
GS 300	98-05	Black/White	Green/Black	Blue/Red	Yellow	Camry	00-04	Blue/Orange	Pink/Green	Blue/Yellow	Red/White
GS 400	98-00	Black/White	Green/Black	Blue/Red	Yellow		96-00	Red/Blue	Green/White	Blue/Yellow	Blue/Black
GS 430	01-05	Black/White	Green/Black	Blue/Red	Yellow	*Camry 2003 - 2004 - 4 Cylinder Engines Only	01	Red/Blue	Green/White	Blue/Yellow	Blue/Black
	IS300	01	Purple	Green	Pink		Black/Yellow	02-04*	Red/Blue	Green/White	Blue/Yellow
LS 400	98-00	Red/Black	Red/White	Red	Yellow	Highlander	99-03	Pink	Gray/Blue	Gray	Blue
LX 470	98-02	Purple/Green	Blue/Black	Red/Yellow	Red/White	Land Cruiser	98-10	Purple/Green	Blue/Black	Red/Yellow	Red/Black
RX 300	99	Black	Purple	Gray	Blue	MR2 Spider	03-05	Yellow	Yellow/Green	Yellow/Black	Blue/Red
	00-03	Pink	Purple	Gray	Blue	RAV4	01-03	Yellow	Yellow/Green	Yellow/Black	Blue/Red
SC300	99-00	Blue	Black/Orange	Green/Orange	Yellow	Sienna	99-03	Brown/Red	Brown/White	Brown/Yellow	Blue/Black
SC400	99-00	Blue	Black/Orange	Green/Orange	Yellow	Solara	99-03	Red/Blue	Green/White	Blue/Yellow	Blue/Black

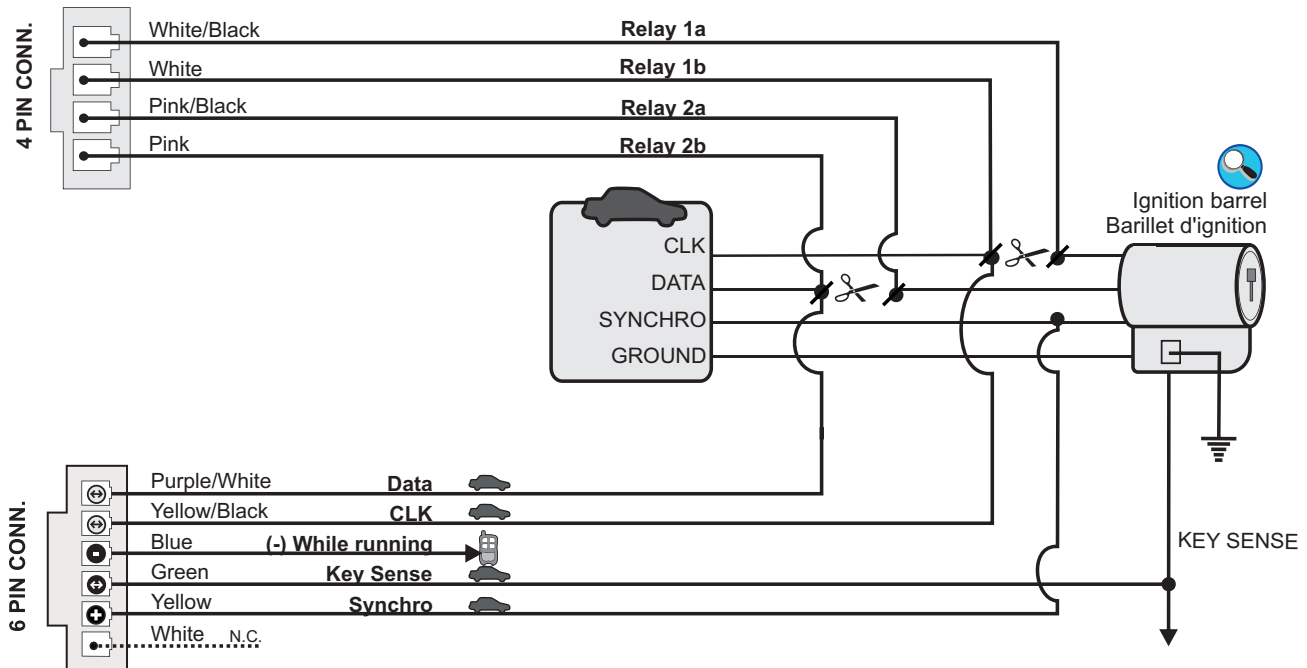

	Input Entrée		Connect to vehicle Branchement au véhicule		Connect to Remote-Starter/Alarm Branchement au démarreur à distance/Alarme
	Output Sortie				

CONNECTION 6

ACURA / HONDA

GO PROGRAM: 5A

Honda	Data Pin 2	Security Light Pin 5	Ignition Pin 6	Acura	Data Pin 2	Security Light Pin 5	Ignition Pin 6
Accord	Red/Blue	Blue/Orange	Black/Yellow	1.7EL	Red/Blue	Blue/Orange	Yellow/Black
Civic	Red/Blue	Blue/Orange	Yellow/Black	MDX	Red	Pink	Green/White
CRV	White	Blue/Orange	Yellow/Black	RL	Lt. Green	Red	Pink
Element	White	Blue/Orange	Yellow/Black	RSX	Red/Blue	Blue/Orange	Yellow/Black
Fit	Light Green/Black	Red/Black	Yellow/Black	TL	Yellow	Orange	Black/Green
Odyssey	Red/Blue	Blue/Orange	Yellow/Black	TSX	Red/Blue	Blue/Orange	Yellow/Black
Pilot	Red/Green	White/Blue	Red/White				
Ridgeline	Red/Blue	Blue/Orange	Green/Black				
S-2000	Red/Blue	Pink	Black/Yellow				

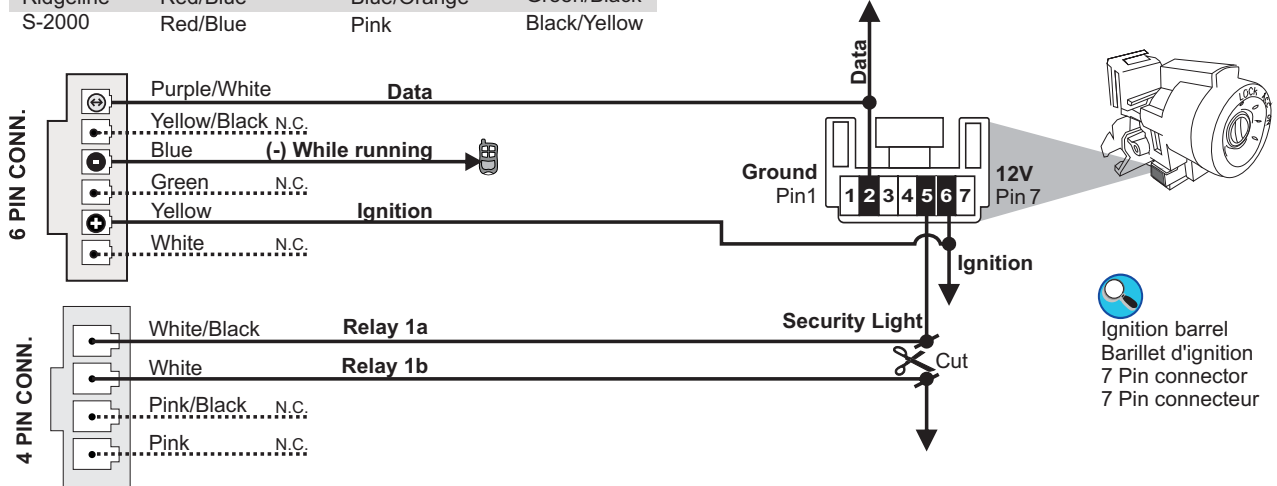

CONNECTION 7

ACURA / HONDA

GO PROGRAM: 5A

Acura	Ignition Pin 1	Data Pin 2	Synchro Pin 3	Ground Pin 4	Honda	Ignition Pin 1	Data Pin 2	Synchro Pin 3	Ground Pin 4
1.6EL	Yellow/Black	Red	Blue/White	Brown/Yellow	Accord	Yellow/Black	Red	Blue	Brown/Black
CL	Yellow/Black	Red	Blue	Brown/Black	CRV	Yellow/Black	Red	Blue	Brown/Black
Integra	Yellow/Black	Red	Blue	Brown/Black	Odyssey	Yellow/Black	Blue/Green	Orange/Blue	Brown/Black
MDX	Yellow/Black	Red	Blue	Brown/Black	Pilot	Yellow/Black	Red	Blue	Brown/Black
TL	Yellow/Black	Red	Blue	Brown/Black	S-2000	Yellow/Black	Red/Blue	Pink/Blue	Brown/Black

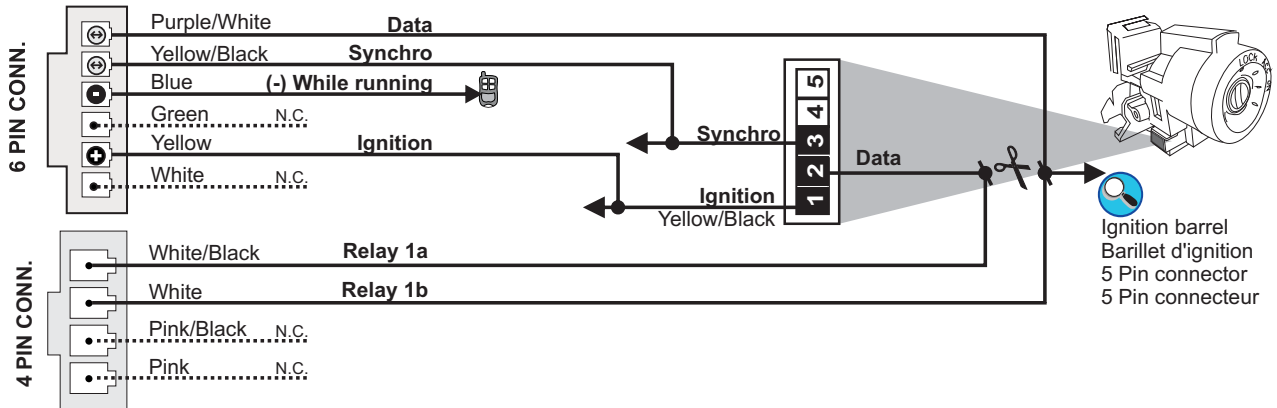

CONNECTION 8

ACURA / HONDA

GO PROGRAM: 5A

Acura	Data Pin 3	Ignition Pin 2	Honda	Data Pin 3	Ignition Pin 2
CSX	Small Light Green	Yellow	Civic	Small Light Green	Yellow
MDX	Small Light Green	Brown	CR-V	Small Green	Blue
RDX	Small Light Green	Yellow	CR-Z	Pink	Brown
			Fit	Green	Red
			Insight	Green	Red

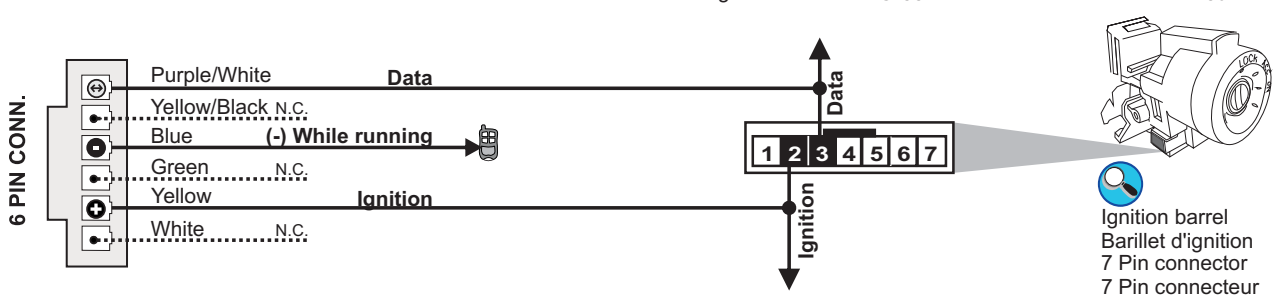

CONNECTION 9

ACURA / HONDA

GO PROGRAM: 5A

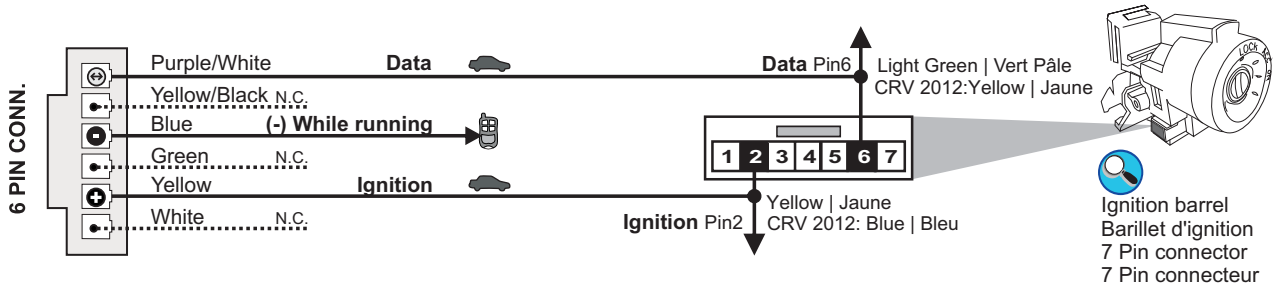

CONNECTION 10 CHEVROLET AVEO (SL) / PONTIAC WAVE / SUZUKI SWIFT GO PROGRAM: 5B

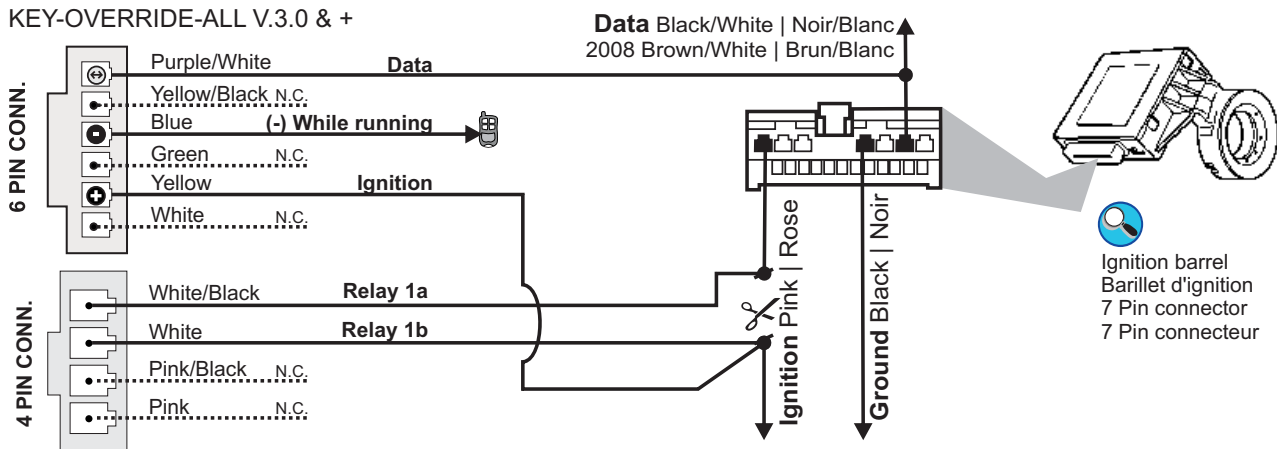

CONNECTION 11 CHEVROLET EPICA / SUZUKI VERONA GO PROGRAM: 5B

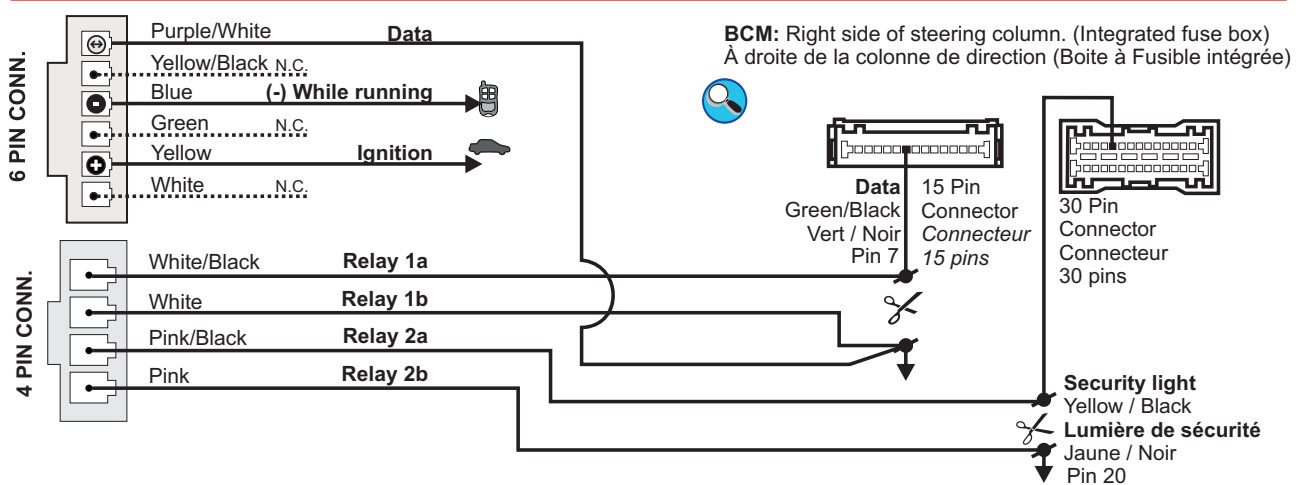

CONNECTION 12 HYUNDAI XG 300 / XH 350 GO PROGRAM: 5B

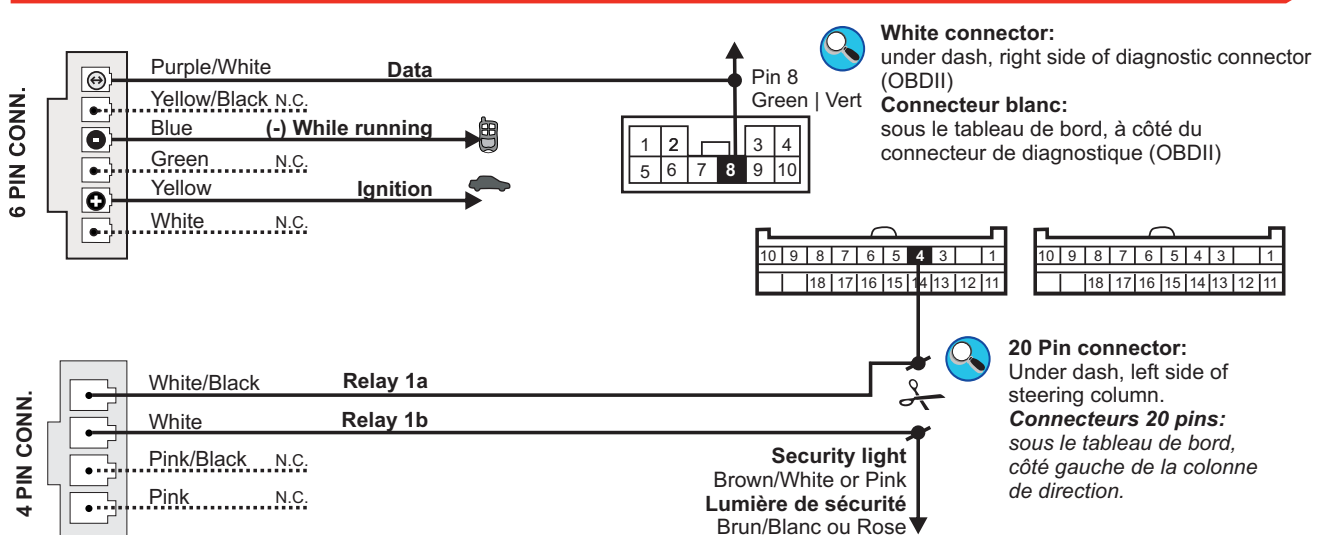

CONNECTION 13

HYUNDAI TIBURON V6

GO PROGRAM: 5B

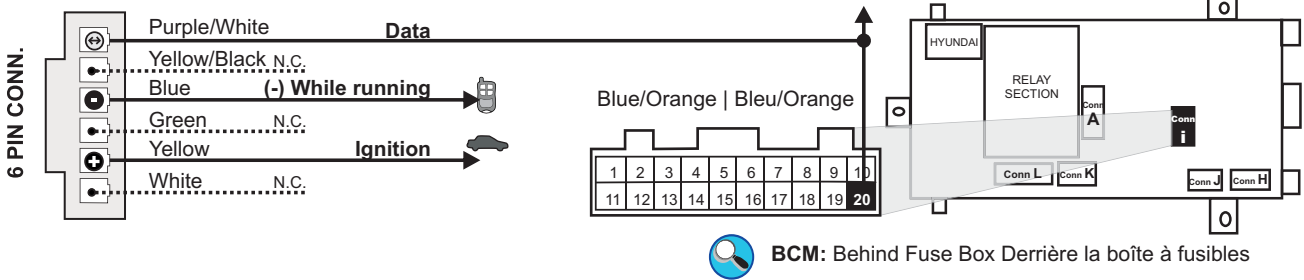

CONNECTION 14

KIA / HYUNDAI

GO PROGRAM: 5B

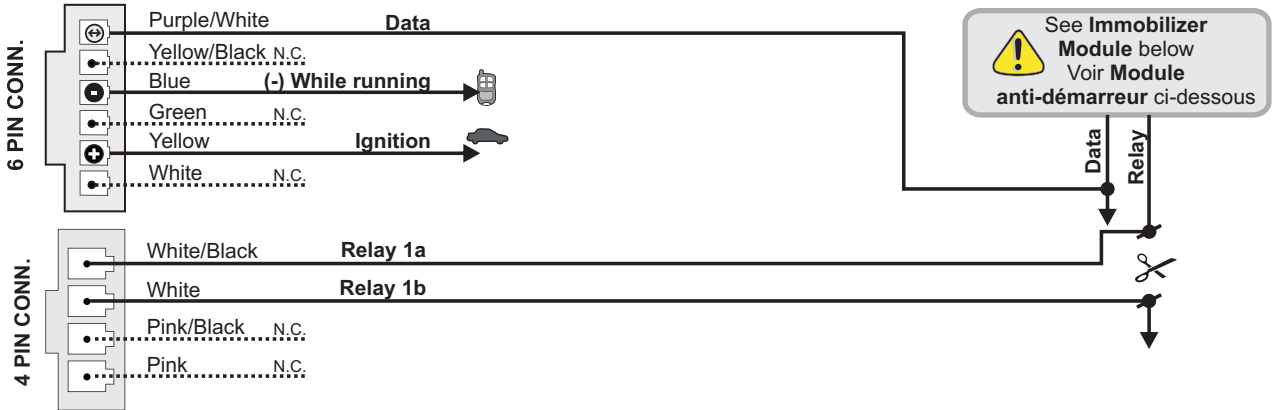

KIA	DATA Pin 2	RELAY Pin 6
Sportage V6	Brown/Orange	White/Black
HYUNDAI		
Tucson V6	Brown/Orange	White/Black

8-pin connector

Immobilizer Module:
Left side of steering column.
Module anti-démarrreur:
À gauche de la colonne de direction.

KIA	DATA Pin 7	RELAY Pin 2
Sedona 2004	Red	Green or Orange
Sorento	Blue	Blue/Orange

10-pin connector

Immobilizer Module:
Right side of steering column.
Module anti-démarrreur:
À droite de la colonne de direction.

KIA	DATA Pin 8	RELAY Pin 3
Sedona 2005	Red	Orange (Security Light)

10-pin connector

Immobilizer Module:
Right side of steering column.
Module anti-démarrreur:
À droite de la colonne de direction.

CONNECTION 15

NISSAN / INFINITI

GO PROGRAM: 5C

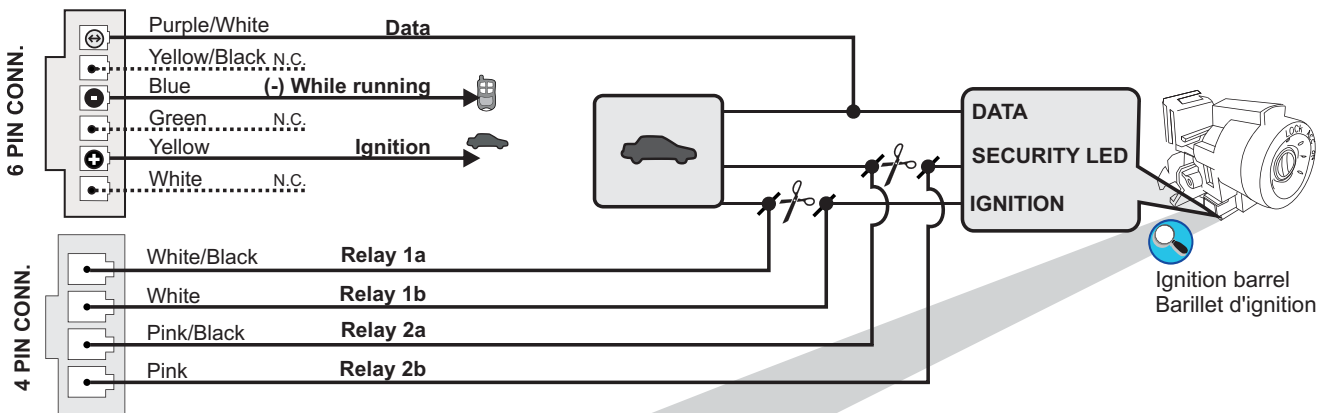

PIN #	DESCRIPTION	PIN #	DESCRIPTION
6	DATA	8	DATA
5	N.C.	7	N.C.
4	GROUND	6	N.C.
3	SECURITY LED	5	GROUND
2	IGNITION	4	SECURITY LED
1	12V Battery	3	N.C.
		2	IGNITION
		1	12V Battery

OR / OU

6-pin connector

8-pin connector

CONNECTION 16

MAZDA MIATA / MPV

GO PROGRAM: 5D

MAZDA	Data Pin 5	Ignition Pin 7
MPV 2000-2003	Blue/White	Black/White
MPV 2004-2006	Blue/White	Black/White
Miata 2001-2004	Red/Black	Black/White

Firmware version 3.02+ required
Version logicielle 3.02+ requise

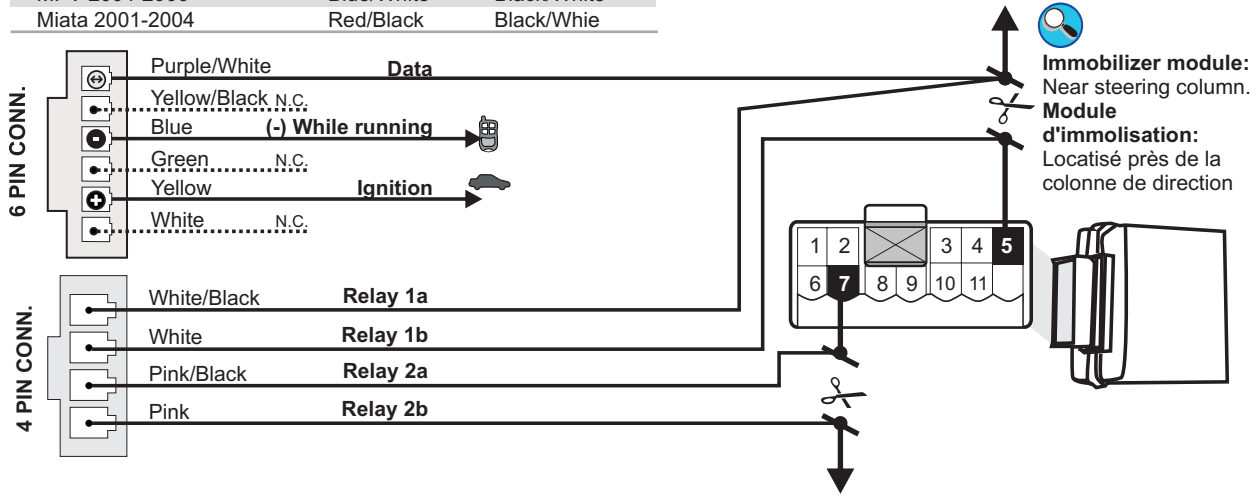

CONNECTION 17

ACURA RL & HONDA PRELUDE

GO PROGRAM: 5A

ACURA YEARS	Data Pin 6	Ignition Pin 4	Start Enable Pin 3
RL 98-04	White	Yellow/Black	Pink

HONDA YEARS	Data Pin 6	Ignition Pin 4	Start Enable Pin 3
Prelude 97	Brown/Yellow	Black/Yellow	Lt Blue
98-01	Brown/Yellow	Yellow/Black	Lt Blue

Firmware version 3.03+ required
Version logicielle 3.03+ requise

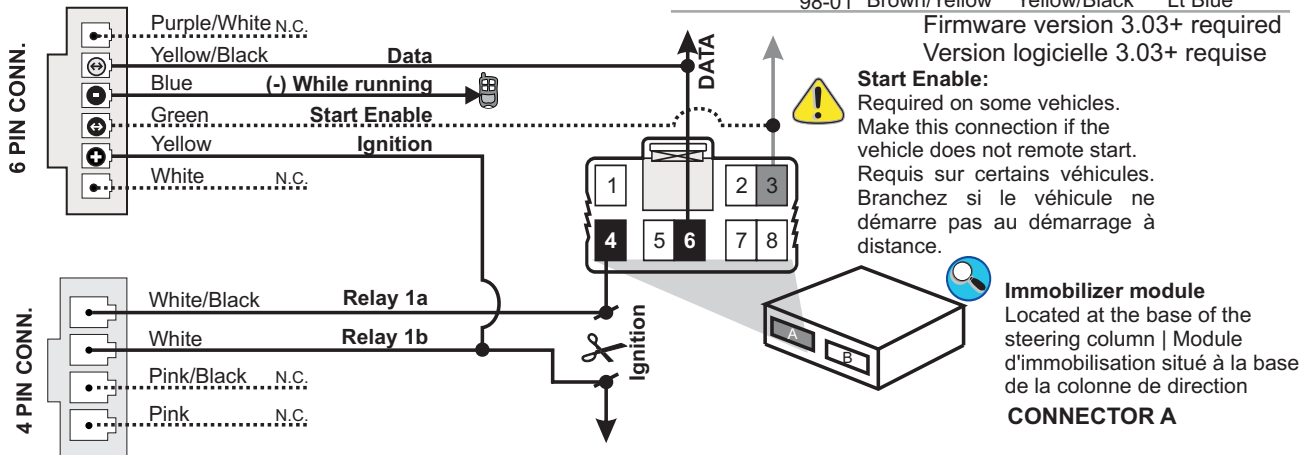

CONNECTION 18

ACURA RL 2005-2008

GO PROGRAM: 5A

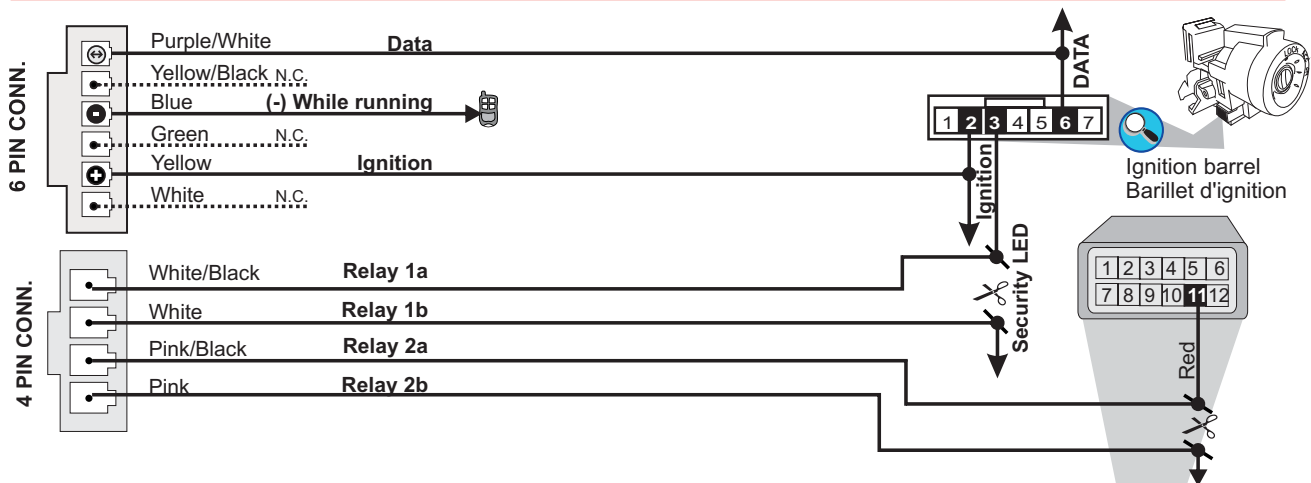

ACURA YEARS	Data Pin 2	Ignition Pin 6	Security Light Pin 5
RL 05-06	Lt Green or Orange	Pink	Blue or Red
07-10	Orange	Pink	Red

Keyless access indicator:
Indicateur d'accès sans clé:
Grey connector located behind the electric mirror switch at left of the steering wheel. | Connecteur épissure Gris situé derrière le commutateur de miroir élect. à gauche de la colonne de direction.

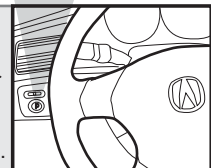

CONNECTION 19

TOYOTA / SCION G STAMPED KEY

GO PROGRAM: 3

Photos with each connectors location are available in the vehicle specific installation guides at www.fortinbypass.com.
Photos des connecteurs et des locations sont disponibles dans les guides individuels des véhicules sur www.fortinbypass.com



Back view | Vue de dos

Firmware version 4.00+ required
Version logicielle 4.00+ requise

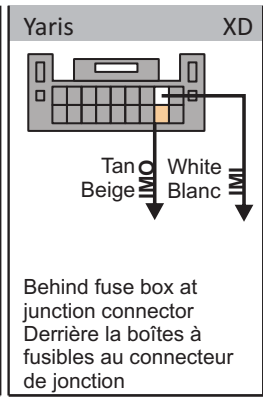
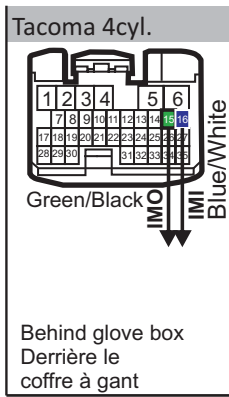
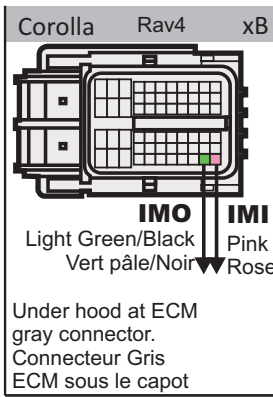
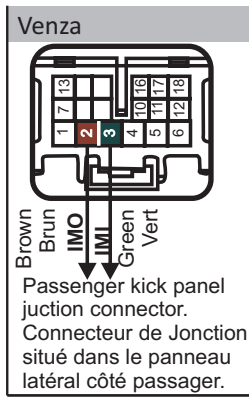
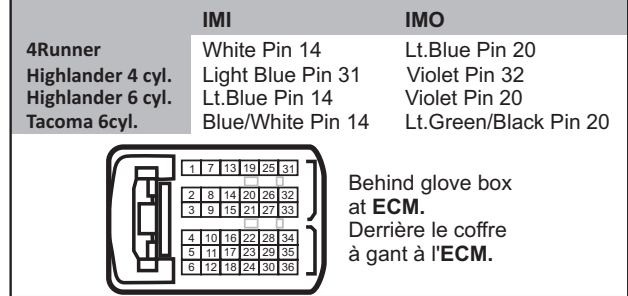
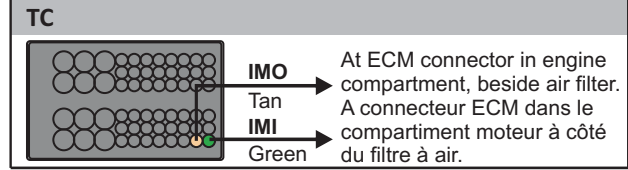
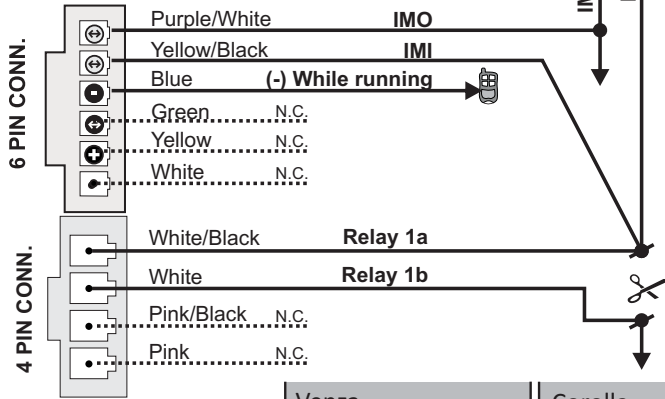

CONNECTION 20

TOYOTA G STAMPED KEY

GO PROGRAM: 3

Photos with each connectors location are available in the vehicle specific installation guides at www.fortinbypass.com.
Photos des connecteurs et des locations sont disponibles dans les guides individuels des véhicules sur www.fortinbypass.com



Back view | Vue de dos

Firmware version 4.00+ required
Version logicielle 4.00+ requise

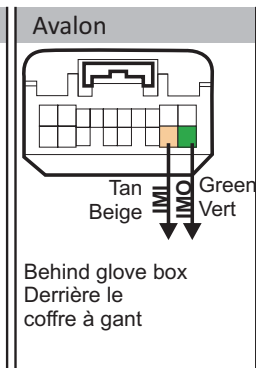
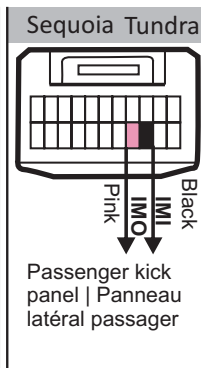
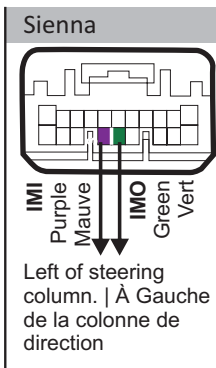
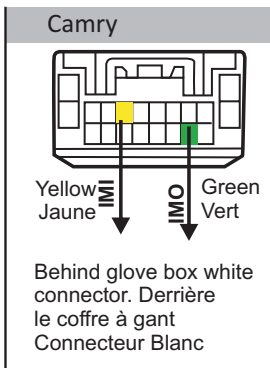
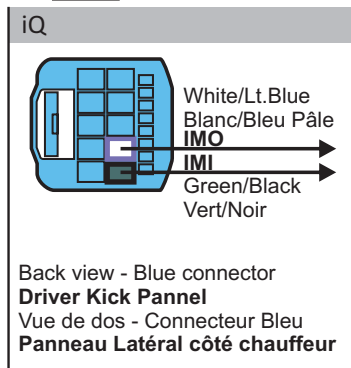
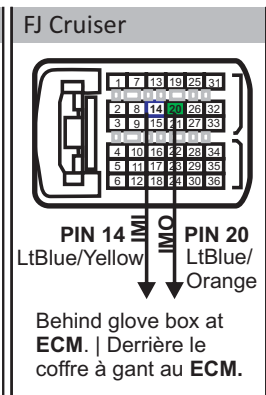
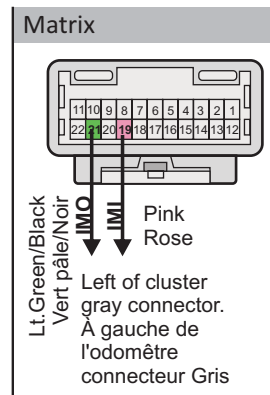
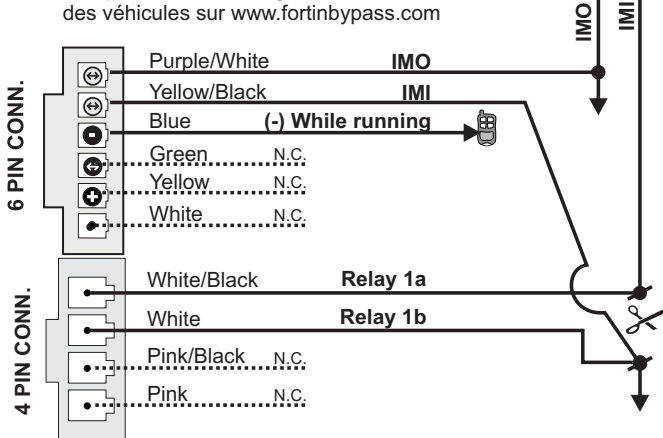



PROGRAM. 1



FORD / JAGUAR / MAZDA / LINCOLN / MERCURY



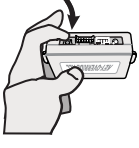
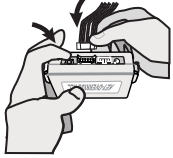

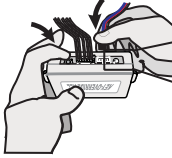
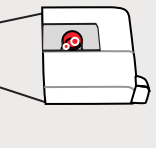
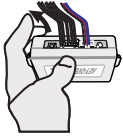
1 key required 1 clé requise

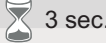
<p>Vehicle equipped with SMART KEY Véhicule équipé d'une clé INTELLIGENTE</p>	 <p>Remove all keys from key remotes. Retirez les clés des télécommandes.</p>	 <p>Keep all cards at least 3 meters (10 feet) away from the vehicle. Éloignez les télécommandes du véhicule (10 pieds / 3 mètres minimum).</p>
---	--	---



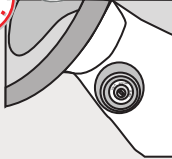

1

 <p>Press and hold the programming button: Appuyez et maintenez enfoncé le bouton de programmation:</p>	 <p>Insert connector 2. (6-pin) Insérez le connecteur 2 (6-pins).</p>	 <p>Insert connector 3. (4-pin - if required) Insérez le connecteur 3 (4-pins - si requis).</p>	 <p>Insert the 4-pin (Data-Link) connector. Insérez le connecteur 4-pins (Data-Link).</p>	 <p>The RED LED will turn ON. La DEL ROUGE s'allumera.</p>	 <p>Release the programming button. Relâchez le bouton de programmation.</p>
---	---	---	---	--	--



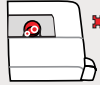
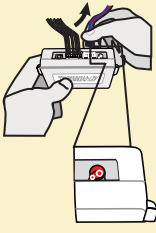

2  **3 sec.** **5 sec. max**  **3**  **3 sec.**

 <p>Turn the first key to the ON/RUN position. Tournez la clé #1 à la position ON/RUN.</p>	 <p>Wait 3 seconds or until the security light turns OFF. Attendre 3 secondes ou jusqu'à ce que la lumière sécurité du tableau de bord s'éteigne.</p>	 <p>Turn the key to the OFF position and remove the first key. Tournez la clé à la position ARRÊT (OFF) et retirez la clé du barillet.</p>	 <p>Wait 3 seconds. Attendre 3 secondes.</p>	 <p>Turn the first key to the ON/RUN position. Tournez la clé #1 à la position ON/RUN.</p>	 <p>Wait 3 seconds or until the security light turns OFF. Attendre 3 secondes ou jusqu'à ce que la lumière sécurité du tableau de bord s'éteigne.</p>
--	---	--	--	--	---

5 sec. max **AUTOMATIC Transmission AUTOMATIQUE**

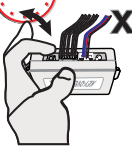
 <p>Turn the key to the OFF position and remove the key. Tournez la clé à la position ARRÊT (OFF) et retirez la clé du barillet.</p>	 <p>Activate the remote starter. Actionnez le démarreur à distance.</p>	 <p>The RED LED will flash ten (10x) times. La DEL ROUGE clignotera dix (10x) fois.</p>	 <p>If the LED is solid RED disconnect the 4-pin connector (Data-Link) and go back to step 1. Si le DEL est Rouge solide débranchez le connecteur 4-pins (Data-Link) et retournez à l'étape 1.</p>	 <p>The module is now programmed. Le module est programmé.</p>
--	--	---	--	---

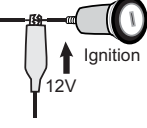
OR OU **5 sec. max** **MANUAL Transmission MANUEL**

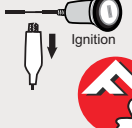
 <p>Press and release the programming button. Pesez et relâchez le bouton de programmation.</p>	 <p>The RED LED will flash once (1x). La DEL ROUGE clignote une (1x) fois.</p>	 <p>Using a jumper wire, apply power (12v) to the vehicles ignition. À l'aide d'un fil (jumper) appliquez 12v sur l'ignition du véhicule.</p>	 <p>The RED LED will flash ten (10x) times. La DEL ROUGE clignotera dix (10x) fois.</p>	 <p>If the LED is solid RED disconnect the 4-pin connector (Data-Link) and go back to step 1. Si le DEL est Rouge solide débranchez le connecteur 4-pins (Data-Link) et retournez à l'étape 1.</p>	 <p>Remove the jumper. The module is now programmed. Retirez le fil (jumper). Le module est programmé.</p>
---	--	--	--	---	---

PROGRAM. 2

FORD / JAGUAR / MAZDA / LINCOLN / MERCURY

2 keys required 2 clés requises

Vehicle equipped with SMART KEY Véhicule équipé d'une clé INTELLIGENTE	Remove all keys from key remotes. Retirez les clés des télécommandes.	Keep all cards at least 3 meters (10 feet) away from the vehicle. Éloignez les télécommandes du véhicule (10 pieds / 3 mètres minimum).
---	--	--

1

Press and hold the programming button: Appuyez et maintenez enfoncé le bouton de programmation:	Insert connector 2. (6-pin) Insérez le connecteur 2 (6 pins).	Insert connector 3. (4-pin - if required) Insérez le connecteur 3 (4-pins - si requis).	Insert the 4-pin (Data-Link) connector. Insérez le connecteur 4-pins (Data-Link).	The RED LED will turn ON. La DEL ROUGE s'allumera.	Release the programming button. Relâchez le bouton de programmation.
--	--	--	--	---	---

2

Turn the first key to the ON/RUN position. Tournez la clé #1 à la position ON/RUN.	Wait 3 seconds or until the security light turns OFF. Attendre 3 secondes ou jusqu'à ce que la lumière sécurité du tableau de bord s'éteigne.	Turn the key to the OFF position and remove the first key. Tournez la clé à la position ARRÊT (OFF) et retirez la clé du barillet.	Wait 3 seconds. Attendre 3 secondes.	Turn the second key to the ON/RUN position. Tournez la seconde clé à la position ON/RUN.	Wait 3 seconds or until the security light turns OFF. Attendre 3 secondes ou jusqu'à ce que la lumière sécurité du tableau de bord s'éteigne.
---	--	---	---	---	--

5 sec. max AUTOMATIC Transmission AUTOMATIQUE

Turn the key to the OFF position and remove the key. Tournez la clé à la position ARRÊT (OFF) et retirez la clé du barillet.	Activate the remote starter. Actionnez le démarreur à distance.	The RED LED will flash ten (10x) times. La DEL ROUGE clignotera dix (10x) fois.	If the LED is solid RED disconnect the 4-pin connector (Data-Link) and go back to step 1. Si le DEL est Rouge solide débranchez le connecteur 4-pins (Data-Link) et retournez à l'étape 1.	The module is now programmed. Le module est programmé.
---	--	--	---	---

OR **5 sec. max** MANUAL Transmission MANUEL

Turn the key to the OFF position and remove the key. Tournez la clé à la position ARRÊT (OFF) et retirez la clé du barillet.	Press and release the programming button. Pesez et relâchez le bouton de programmation.	The RED LED will flash once (1x). La DEL ROUGE clignote une (1x) fois.	Using a jumper wire, apply power (12v) to the vehicles ignition. À l'aide d'un fil (jumper) appliquez 12v sur l'ignition du véhicule.	The RED LED will flash ten (10x) times. La DEL ROUGE clignotera dix (10x) fois.	If the LED is solid RED disconnect the 4-pin connector (Data-Link) and go back to step 1. Si le DEL est Rouge solide débranchez le connecteur 4-pins (Data-Link) et retournez à l'étape 1.	Remove the jumper. The module is now programmed. Retirez le fil (jumper). Le module est programmé.
---	--	---	--	--	---	---

PROGRAM. 3

TOYOTA / LEXUS

1



Press and hold the programming button:
Appuyez et maintenez enfoncé le bouton de programmation:



Insert connector 2. (6-pin)
Insérez le connecteur 2 (6-pins).



Insert connector 3. (4-pin - if required)
Insérez le connecteur 3 (4-pins - si requis).

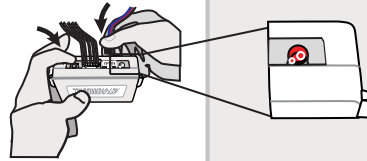

Insert the 4-pin (Data-Link) connector.
Insérez le connecteur 4-pins (Data-Link).

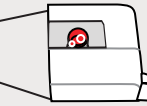

The RED LED will turn ON.
La DEL ROUGE s'allumera.

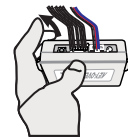

Release the programming button.
Relâchez le bouton de programmation.

2



Vehicle with 80-bit G-key:
Véhicule avec 80-bits G-Key:
Start the vehicle with the key.
Démarrez le véhicule avec la clé.



Other vehicle:
Autre véhicule:
Insert one functional key in to the ignition barrel. Do not turn the key.
Insérez la clé fonctionnelle dans le barillet. Ne tournez pas la clé.



The RED LED will flash ten (10x) times.
La DEL ROUGE clignotera dix (10x) fois.

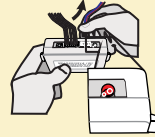

If the LED is solid RED disconnect the 4-pin connector (Data-Link) and go back to step 1.
Si le DEL est Rouge solide débranchez le connecteur 4-pins (Data-Link) et retournez à l'étape 1.



The module is now programmed.
Le module est programmé.

PROGRAM. 4

TOYOTA / LEXUS (SMART KEY)

1

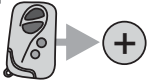

Remove the battery from 1 OEM remote.
Retirez la pile d'une des télécommandes d'origine.

2

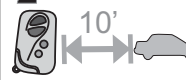

Keep the other OEM remotes away from the vehicle. Minimum 3 meters (10 feet).
Éloignez les autres télécommandes d'origine à plus de 3 mètres (10 pieds) du véhicule.

3



Press and hold the programming button:
Appuyez et maintenez enfoncé le bouton de programmation:

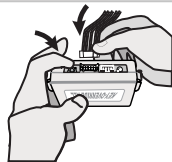

Insert connector 2. (6-pin)
Insérez le connecteur 2 (6-pins).



Insert connector 3. (4-pin - if required)
Insérez le connecteur 3 (4-pins - si requis).

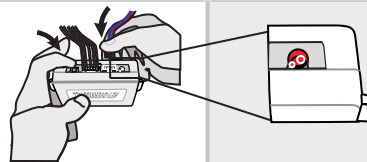

Insert the 4-pin (Data-Link) connector.
Insérez le connecteur 4-pins (Data-Link).

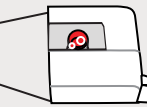

The RED LED will turn ON.
La DEL ROUGE s'allumera.

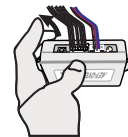

Release the programming button.
Relâchez le bouton de programmation.

4

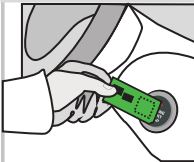

Hold the OEM remote (without battery) against the START/STOP button.

Appuyez la télécommande d'origine (sans batterie) devant le bouton ENGINE START/STOP comme illustrée.

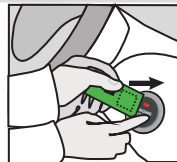

Press and hold the Start/Stop button.

Pesez et maintenez enfoncé le bouton Start/Stop.



The RED LED will flash ten (10x) times.

La DEL ROUGE clignotera dix (10x) fois.



If the LED is solid RED disconnect the 4-pin connector (Data-Link) and go back to step 1.
Si le DEL est Rouge solide débranchez le connecteur 4-pins (Data-Link) et retournez à l'étape 1.



The module is now programmed.

Le module est programmé.

Release the Start/Stop button.
Make all the connection at the KEY-OVERRIDE-ALL yellow wire if required.
Reinstall the battery in the OEM remote.

Relâchez le bouton Start/Stop.
Effectuez les branchements au fil Jaune si requis du KEY-OVERRIDE-ALL.
Remettez la pile dans la télécommande d'origine.

PROGRAM. 5 ACURA / HONDA / CHEVROLET / HYUNDAI / KIA / PONTIAC / SUZUKI / NISSAN / INFINITI / MAZDA

1



Press and hold the programming button:
Appuyez et maintenir enfoncé le bouton de programmation:



Insert connector 2. (6-pin)
Insérez le connecteur 2 (6-pins).



Insert connector 3. (4-pin - if required)
Insérez le connecteur 3 (4-pins - si requis).

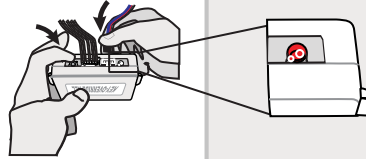

Insert the 4-pin (Data-Link) connector.
Insérez le connecteur 4-pins (Data-Link).

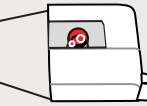

The RED LED will turn ON.
La DEL ROUGE s'allumera.

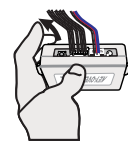

Release the programming button.
Relâchez le bouton de programmation.

2

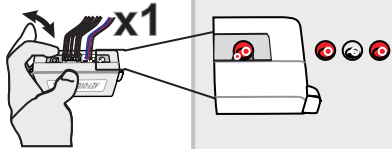

Press and Release the programming button.
Appuyez et relâchez le bouton de programmation.

The RED LED will turn OFF and turn back ON.
La DEL ROUGE s'éteint et se rallume.

3

Press the programming button (x) times.
Appuyez et relâchez le bouton de programmation (x) fois.

The RED LED will turns OFF and turn back ON (x) times.
La DEL ROUGE s'éteint et se rallume (x) fois.

A ACURA
HONDA

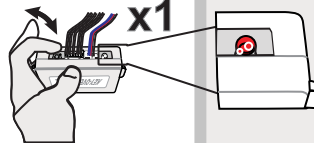

x1

B CHEVROLET
HYUNDAI
KIA
PONTIAC
SUZUKI

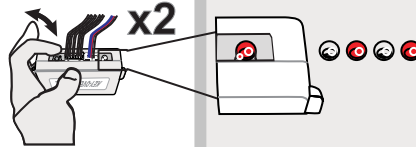

x2

C NISSAN
INFINITI

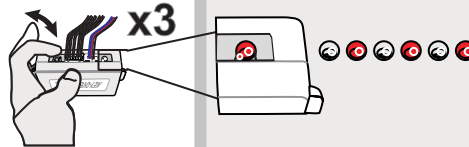

x3

D MAZDA
MIATA
MPV

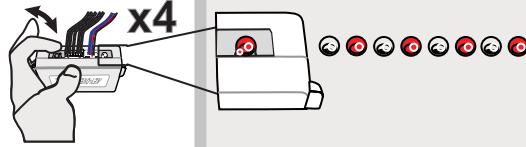

x4

E CHEVROLET
PONTIAC
OLDSMOBILE

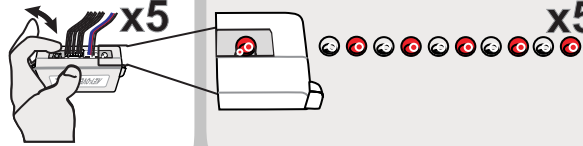

x5

4

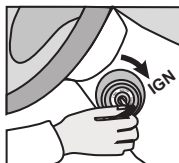

Turn the Ignition to the ON/RUN position.
Miata & MPV: **Start** the vehicle.
Tournez la clef en position ignition (ON).
MIATA & MPV : **Démarrez** le véhicule.



The RED LED will flash ten (10x) times.
La DEL ROUGE clignotera dix (10x) fois.

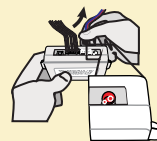

If the LED is solid RED disconnect the 4-pin connector (Data-Link) and go back to step 1.
Si le DEL est Rouge solide débranchez le connecteur 4-pins (Data-Link) et retournez à l'étape 1.



The module is now programmed.
Le module est programmé.

Use the remote of the remote starter or security system to test all of the supported features to ensure proper programming.

Testez toutes les fonctions supportées sur le véhicule avec la télécommande du démarreur à distance ou du système de sécurité.

PROGRAM. 6

FORD / MAZDA

SCAN TOOL REQUIRED | SCAN TOOL REQUIS

Vehicle equipped with SMART KEY
Véhicule équipé d'une clé INTELLIGENTE



Remove all keys from key remote cards.

Retirez les 2 clés des télécommandes. (cartes).

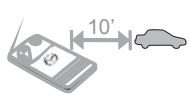

Keep all cards at least 3 meters (10 feet) away from the vehicle to proceed.

Éloignez les télécommandes du véhicule (10 pieds / 3 mètres minimum) pour procéder à la programmation.

1 Or | Ou



Insert the key in to the ignition barrel.

Insérez la clé dans le barillet d'ignition.



Press the Push to start button to turn ON the ignition.

Appuyez sur le bouton démarrage pour mettre l'ignition en position ON.



Wait 1 minute.

Attendez (1) une minute.

1



Press and hold the programming button:
Appuyez et maintenez enfoncé le bouton de programmation:



Insert connector 2. (6-pin)
Insérez le connecteur 2 (6-pins).



Insert connector 3. (4-pin - if required)
Insérez le connecteur 3 (3-pins - si requis).

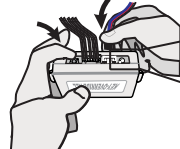

Insert the 4-pin (Data-Link) connector.
Insérez le connecteur 4-pins (Data-Link).

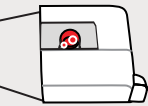

The RED LED will turn ON.
La DEL ROUGE s'allumera.

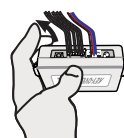

Release the programming button.
Relâchez le bouton de programmation.

A DEALER SCAN TOOL IS REQUIRED. The following steps should be performed by a qualified technician:
Le SCAN TOOL DU CONCESSIONNAIRE EST REQUIS. La procédure suivante doit être effectuée par un technicien qualifié.

2

Connect the SCAN TOOL .
Navigate the SCAN TOOL menu to **program** a new ignition key to the vehicle.

Branchez le SCAN TOOL. **Suivre** les indications du SCAN TOOL pour **programmer** une nouvelle clé d'ignition.

When the SCAN TOOL is ready to program a new key:

Lorsque le SCAN TOOL du concessionnaire est prêt à programmer la nouvelle clé:



Remove the key from the ignition barrel.

Retirez la clé du barillet d'ignition **sans éteindre** l'ignition.



Press and release the programming button on the module.
Appuyez et relâchez le bouton de programmation du module.

Complete the programming on the dealer scan tool.

Exécutez la fonction de programmation de la nouvelle clé indiquée sur le Scan Tool.

Programming was successful if the dealer scan tool indicates that a new ignition key has been programmed to the vehicle.

La programmation réussie lorsque le scan tool indique qu'une nouvelle clé d'ignition est programmée sur le véhicule.

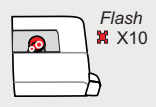

Flash X10

The RED LED will flash ten (10x) times.

La DEL ROUGE clignotera dix (10x) fois.



If the LED is solid RED disconnect the 4-pin connector (Data-Link) and go back to step 1.

Si le DEL est Rouge solide débranchez le connecteur 4-pins (Data-Link) et retournez à l'étape 1.



The module is now programmed.

Le module est programmé.

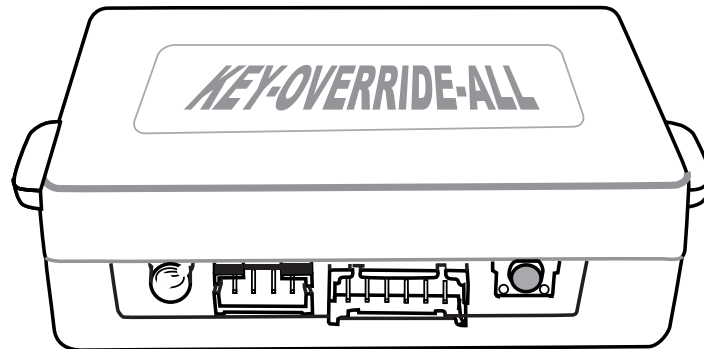

TECHNICAL SUPPORT / INFORMATION

Neither the manufacturer or distributor of this module is responsible for damages of any kind either indirectly or directly caused by this module, except for the replacement of this module in case of manufacturing defects. This module must be installed by a qualified technician.

This instruction guide may change without notice. Visit www.fortinbypass.com to obtain the latest version.

INFORMATIONS / SUPPORT TECHNIQUE

Ni le manufacturier, ni le distributeur ne se considèrent responsables des dommages causés ou ayant pu être causés, indirectement ou directement, par ce module, excepté le remplacement de ce module en cas de défectuosité de fabrication. Ce module doit être installé par un technicien qualifié.

Ce guide d'instruction peut faire l'objet de changement sans préavis. Consultez le www.fortinbypass.com pour voir la plus récente version.

www.fortinbypass.com

WEB UPDATE | MISE À JOUR INTERNET



TECHNICAL SUPPORT

Tél: 514-255-HELP (4357)

1-877-336-7797



INSTALLATION GUIDE



7 70350100131 5